

3406FR-HDBNC Fiber Optic SFP HD-BNC Frame User Manual



© Copyright 2020

EVERTZ MICROSYSTEMS LTD.

5288 John Lucas Drive,
Burlington, Ontario, Canada
L7L 5Z9

Phone: +1 905-335-3700
Sales Fax: +1 905-335-3573
Tech Support Phone: +1 905-335-7570
Tech Support Fax: +1 905-335-7571

Sales: sales@evertz.com
Tech Support: service@evertz.com
Web Page: <http://www.evertz.com>



Version 1.0, October 2020

The material contained in this manual consists of information that is the property of Evertz Microsystems and is intended solely for the use of purchasers of the 3406FR Series. Evertz Microsystems expressly prohibits the use of this manual for any purpose other than the operation of the device.

All rights reserved. No part of this publication may be reproduced without the express written permission of Evertz Microsystems Ltd. Copies of this guide can be ordered from your Evertz products dealer or from Evertz Microsystems.

This page left intentionally blank

IMPORTANT SAFETY INSTRUCTIONS

	The lightning flash with arrowhead symbol within an equilateral triangle is intended to alert the user to the presence of uninsulated “Dangerous voltage” within the product’s enclosure that may be of sufficient magnitude to constitute a risk of electric shock to persons.
	The exclamation point within an equilateral triangle is intended to alert the user to the presence of important operating and maintenance (Servicing) instructions in the literature accompanying the product.

- Read these instructions
- Keep these instructions.
- Heed all warnings.
- Follow all instructions.
- Do not use this apparatus near water
- Clean only with dry cloth.
- Do not block any ventilation openings. Install in accordance with the manufacturer’s instructions.
- Do not install near any heat sources such as radiators, heat registers, stoves, or other apparatus (including amplifiers) that produce heat.
- Do not defeat the safety purpose of the polarized or grounding-type plug. A polarized plug has two blades with one wider than other. A grounding-type plug has two blades and a third grounding prong. The wide blade or the third prong are provided for your safety. If the provided plug does not fit into your outlet, consult an electrician for replacement of the obsolete outlet.
- Protect the power cord from being walked on or pinched particularly at plugs, convenience receptacles and the point where they exit from the apparatus.
- Only use attachments/accessories specified by the manufacturer
- Unplug this apparatus during lightning storms or when unused for long periods of time.
- Refer all servicing to qualified service personnel. Servicing is required when the apparatus has been damaged in any way, such as power-supply cord or plug is damaged, liquid has been spilled or objects have fallen into the apparatus, the apparatus has been exposed to rain or moisture, does not operate normally, or has been dropped.

WARNING

TO REDUCE THE RISK OF FIRE OR ELECTRIC – SHOCK, DO NOT EXPOSE THIS APPARATUS TO RAIN OR MOISTURE

WARNING

DO NOT EXPOSE THIS EQUIPMENT TO DRIPPING OR SPLASHING AND ENSURE THAT NO OBJECTS FILLED WITH LIQUIDS ARE PLACED ON THE EQUIPMENT

WARNING

TO COMPLETELY DISCONNECT THIS EQUIPMENT FROM THE AC MAINS, DISCONNECT THE POWER SUPPLY CORD PLUG FROM THE AC RECEPTACLE

WARNING

THE MAINS PLUG OF THE POWER SUPPLY CORD SHALL REMAIN READILY OPERABLE

FIBER OPTIC DEVICES

Some modules in this product may have fiber optic outputs. The following safety information applies to the optical outputs of these modules. Consult individual chapters for specific safety information for handling fiber optics.

WARNING



**CAUTION – CLASS 1 VISIBLE & INVISIBLE LASER RADIATION WHEN OPEN
DO NOT VIEW DIRECTLY OR WITH OPTICAL INSTRUMENTS.**

ELECTROSTATIC SENSITIVE DEVICES



The hand symbol within an equilateral triangle is intended to alert the user to instructions related to precautions for handling electrostatic-sensitive devices. See “Electro Static Discharge (ESD) Precautions” section for further details.

INFORMATION FOR NEBS COMPLIANT VERSIONS



The intra-building port(s) of this equipment is suitable for connection to intra-building or unexposed wiring or cabling only. The intra-building port(s) of the equipment **MUST NOT** be metalically connected to interfaces that connect to the OSP or its wiring. These interfaces are designed for use as intra-building interfaces only (Type 2 or Type 4 ports as described in GR-1089-CORE, Issue 4) and require isolation from the exposed OSP cabling. The addition of Primary Protectors is not sufficient protection in order to connect these interfaces metalically to OSP wiring.



The intra-building port(s) of the equipment or subassembly must use shielded intra-building cabling/wiring that is grounded at both ends.



This equipment is to be connected to a Common Bonding Network. See Installation section for further information.



This equipment is to be installed in the network telecommunication facilities.



To ensure that radiated emissions do not exceed NEBS requirements, all Ethernet (Cat-5 or better) connections must use shielded cable.

The use of unshielded Ethernet cable may cause excessive electromagnetic radiation in excess of NEBS specifications.

INFORMATION TO USERS IN EUROPE

NOTE

This equipment with the CE marking complies with both the EMC Directive (2004/108/EC) and the Low Voltage Directive (2006/95/EC) issued by the Commission of the European Community.

Compliance with these directives implies conformity to the following European standards:

- EN60950 Product Safety
- EN55103-1 Electromagnetic Interference Class A (Emission)
- EN55103-2 Electromagnetic Susceptibility (Immunity)

This equipment has been tested and found to comply with the limits for a Class A digital device, pursuant to the European Union EMC directive. These limits are designed to provide reasonable protection against harmful interference when the equipment is operated in a commercial environment. This equipment generates, uses, and can radiate radio frequency energy and, if not installed and used in accordance with the instruction manual, may cause harmful interference to radio communications. Operation of this equipment in a residential area is likely to cause harmful interference in which case the user will be required to correct the interference at his own expense.

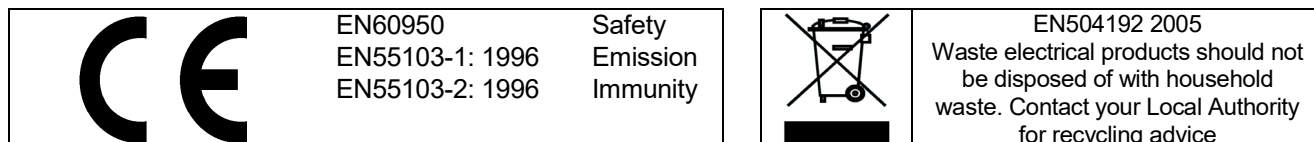

INFORMATION TO USERS IN THE U.S.A.

NOTE

FCC CLASS A DIGITAL DEVICE OR PERIPHERAL

This equipment has been tested and found to comply with the limits for a Class A digital device, pursuant to Part 15 of the FCC Rules. These limits are designed to provide reasonable protection against harmful interference when the equipment is operated in a commercial environment. This equipment generates, uses, and can radiate radio frequency energy and, if not installed and used in accordance with the instruction manual, may cause harmful interference to radio communications. Operation of this equipment in a residential area is likely to cause harmful interference in which case the user will be required to correct the interference at his own expense.

WARNING

Changes or modifications not expressly approved by Evertz Microsystems Ltd. could void the user's authority to operate the equipment. Use of unshielded plugs or cables may cause radiation interference. Properly shielded interface cables with the shield connect

Evertz Microsystems Ltd	This device complies with part 15 of the FCC Rules. Operation is subject to the following two conditions:
	This device may cause harmful interference, and this device must accept any interference received, including interference that may cause undesired operation.
For Commercial Use	
Tested to comply with FCC Standards	

REVISION HISTORY

<u>REVISION</u>	<u>DESCRIPTION</u>	<u>DATE</u>
1.0	First Release	October 2020

Information contained in this manual is believed to be accurate and reliable. However, Evertz assumes no responsibility for the use thereof or for the rights of third parties, which may be effected in any way by the use thereof. Any representations in this document concerning performance of Evertz products are for informational use only and are not warranties of future performance, either expressed or implied. The only warranty offered by Evertz in relation to this product is the Evertz standard limited warranty, stated in the sales contract or order confirmation form.

Although every attempt has been made to accurately describe the features, installation and operation of this product in this manual, no warranty is granted nor liability assumed in relation to any errors or omissions unless specifically undertaken in the Evertz sales contract or order confirmation. Information contained in this manual is periodically updated and changes will be incorporated into subsequent editions. If you encounter an error, please notify Evertz Customer Service department. Evertz reserves the right, without notice or liability, to make changes in equipment design or specifications.

This page left intentionally blank

TABLE OF CONTENTS

1.	OVERVIEW.....	1
1.1.	3406FR-BNC FRAME	1
2.	TECHNICAL SPECIFICATIONS.....	3
2.1.	3406FR-HDBNC FRAME	3
2.2.	COMMUNICATION AND CONTROL	3
2.3.	OPTICAL OUTPUT	3
2.4.	OPTICAL INPUT	3
2.5.	ELECTRICAL INPUTS.....	3
2.6.	ELECTRICAL OUTPUTS.....	4
2.7.	PHYSICAL	4
2.8.	COMPLIANCE	4
3.	INSTALLATION.....	5
3.1.	FAN INSTALLATION AND REMOVAL (3406FAN)	5
3.1.1.	Cooling	5
3.2.	CARE AND HANDLING OF OPTICAL FIBER.....	6
3.2.1.	Safety	6
3.2.2.	Assembly	6
3.2.3.	Labeling	7
3.2.4.	Handling and Connecting Fibers	7
3.3.	FIBER INPUT AND OUTPUT CONNECTIONS.....	7
3.3.1.	Electro Static Discharge (ESD) Precautions.....	9
3.3.2.	3406FR-HDBNC SFP Module Variants	10
3.3.3.	Installing an SFP Module	11
3.3.4.	Removing an SFP Module	11
3.4.	ELECTRICAL INPUT AND OUTPUT CONNECTIONS.....	12
3.4.1.	Rear Panel HD-BNC Connections.....	12
3.5.	SERVICING INSTRUCTIONS	12
3.6.	CHANGING THE FUSES	12
4.	STATUS AND LEDS	13
4.1.	STATUS LED	13
5.	WEBEASY® CONFIGURATION	15
5.1.	SYSTEM	16
5.2.	NETWORK MANAGEMENT	17
5.3.	FRAME MANAGEMENT.....	17

5.4.	SFP	18
5.4.1.	SFP – 3406T-2-12G.....	19
5.4.2.	SFP - 3406R-DA4R-12G.....	19
5.4.3.	SFP – 3406R-2-12G	20
5.5.	NOTIFY	21
6.	3406 SERIES CWDM PASSIVE OPTICAL MODULES	23
6.1.	OVERVIEW	23
6.1.1.	3406CWDM Coarse Wavelength Division Multiplexor	23
6.2.	INSTALLATION	24

Figures

Figure 1-1: 3406FR-HDBNC Frame	1
Figure 1-2: 3406FR-HDBNC Block Diagram	2
Figure 3-1: External Views of 3406FR-HDBNC	5
Figure 3-3: Front View of 3406FAN.....	5
Figure 3-4: Cooling Fan Installation and Removal.....	6
Figure 3-5: Reproduction of Laser Certification and Identification Label.....	7
Figure 3-6: 3406FR-HDBNC Front View with Fiber Inputs and Outputs	8
Figure 3-7: Evertz [®] SFP Modules.....	8
Figure 3-8: 3406FR-HDBNC SFP Module Variants.....	10
Figure 3-9: 3406FR-HDBNC Fixed Electrical Connections.....	12
Figure 4-1: Front of 3406FC.....	13
Figure 5-1: WEBEasy [®] - Navigation Bar	15
Figure 5-2: WebEasy [®] - System	16
Figure 5-3: WEBEasy [®] - Network Management	17
Figure 5-4: WEBEasy [®] - Frame Management	17
Figure 5-5: WEBEasy [®] - SFP	18
Figure 5-6: WEBEasy [®] - SFP – 3406T-2-12G	19
Figure 5-7: WEBEasy [®] - SFP - 3406R-DA4R-12G	19
Figure 5-8: WebEasy [®] - SFP - 3406R-2-12G	20
Figure 5-9: WebEasy [®] - Notify.....	21

Page left intentionally blank

1. OVERVIEW

The Evertz 3406FR-HDBNC Fiber optic SFP HD-BNC is a high-capacity bulk optical conversion platform. With the ability to accommodate 16x Evertz 3406/3405 series SFPs, up to 32x optical-to-electrical or electrical-to-optical conversions may be performed in a single frame.

3406/3405 series SFPs are able to handle ASI, SDI, HD-SDI, 3G and 12G digital video signals, as well as other signal rates up to 12G on non-relocked versions (e.g. MADI). Allow up to 18x signals to be multiplexed on to a single fiber, greatly conserving fiber usage.

All components are hot swappable through the front of the frame including SFP's, frame controllers, multiplexers, and power converters. This ensures the unit can be fully serviceable in the field without having to be de-cabled or removed from the customer's rack. The 3406FR-HDBNC frame accommodates main and redundant AC inlet power supply modules

Features:

- Dual Power supplies (primary and redundant) and conversion trays (front extractable)
- Houses up to 16 front loading Evertz SFP modules
- Each slot can be used as an input or an output based on SFP type
- Dual primary & secondary 3406FR-HDBNC Frame Controllers for full VistaLINK[®] SNMP control and monitoring
- No electrical re-cabling required when hot swapping modules
- Power options include external 12V power supply bricks or 1RU power supply tray which will power up to 6 x 3406FR units with redundancy
- Four additional MSA-compliant SFP slots for fiber to fiber, fiber to coax, fiber to RJ-45 conversions (SFP dependent).
- Accommodates redundant AC inlet power supplies and positive locking high density HD-BNC connectors.

Additional Features for 3406FR-HDBNC:

- Optional bi-directional single or dual Mux/Demux of up to 18 wavelengths in the 1270nm to 1610nm spectrum (ITU-T G.694.2 compliant)
- Optional 48V DC power inlet version
- MTP to LC/UPC fan out cable for convenient fiber connection from Evertz SFPs to Mux/Demux modules

1.1. 3406FR-BNC FRAME

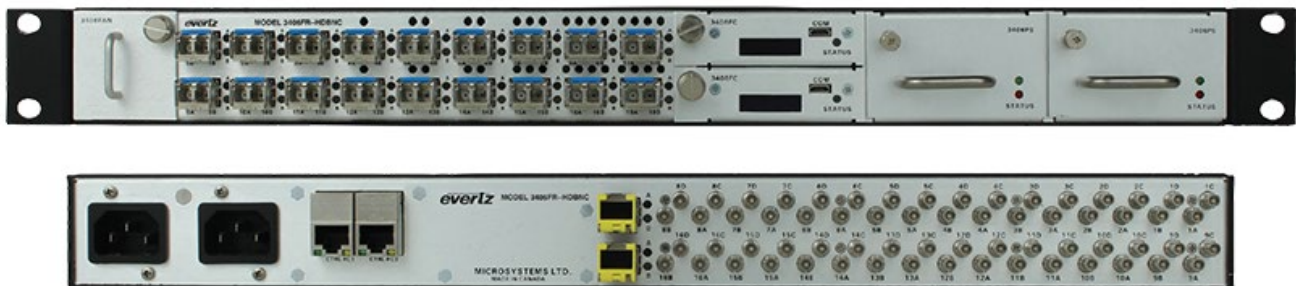
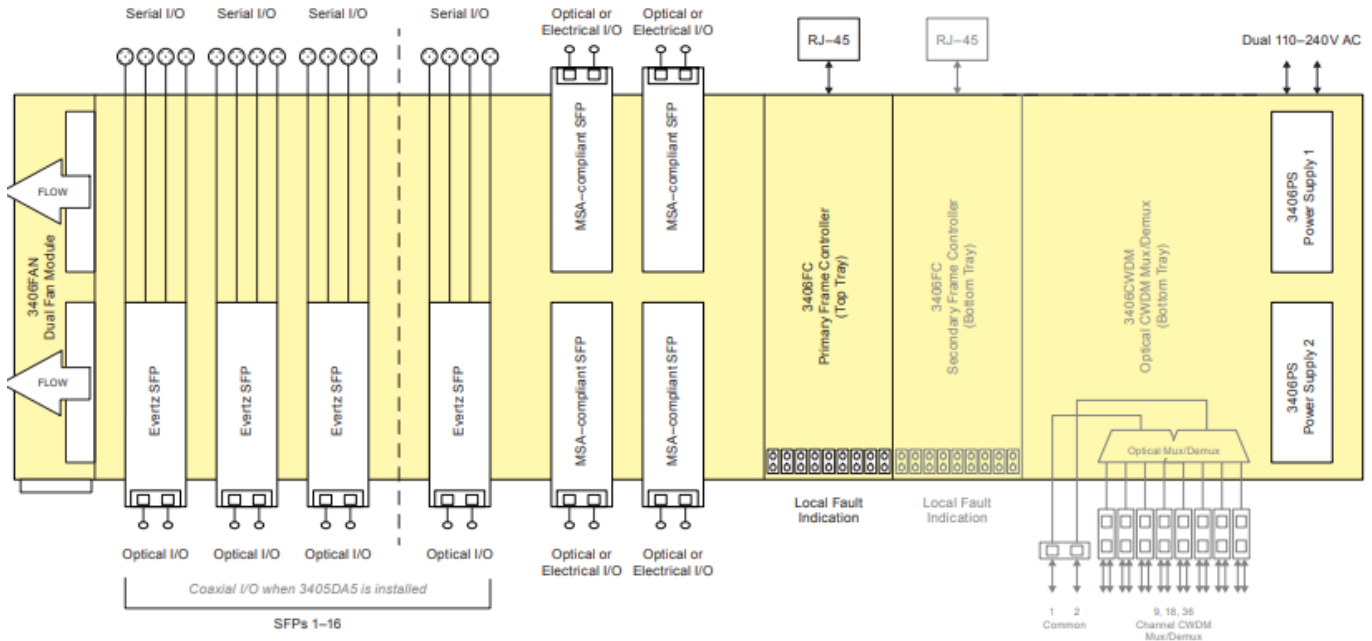

Figure 1-1: 3406FR-HDBNC Frame



Note: optional redundant frame controller (3406FC) cannot be used simultaneously with the 3406CWDW series units

Figure 1-2: 3406FR-HDBNC Block Diagram

2. TECHNICAL SPECIFICATIONS

2.1. 3406FR-HDBNC FRAME

Density:	Up to 32x EO, OE, or a mixture of EO and OE in a 1RU unit,4x MSA-compliant SFP slots for additional SFP to SFP conversions
Impedance:	75 Ω
Connector:	HD-BNC

2.2. COMMUNICATION AND CONTROL

Serial:	RS-232 single micro USB B connector
Ethernet:	SNMP over IEEE 802.3/U (10/100/1000 BaseTx) RJ-45 connector
Control:	VistaLINK [®] , WebEasy

2.3. OPTICAL OUTPUT

Number of Outputs:	Up to 2 per SFP
Connector:	LC/UPC
Fiber:	Compatible with single mode
Rise/Fall Time:	<270ps
Optical Power:	
Standard:	-2dBm \pm 1dBm
CWDM:	-1dBm \pm 1dBm
Wavelength:	
Standard:	1310nm
CWDM:	1270nm-1610nm ITU-T G.694.2 compliant

2.4. OPTICAL INPUT

Number of Inputs:	Up to 2 per SFP
Connector:	LC/UPC
Fiber:	Compatible with single mode
Operating Wavelength:	1270nm to 1610nm
Maximum Input Power:	-1dBm
Optical Sensitivity:	-12dBm at 11.88Gb/s

2.5. ELECTRICAL INPUTS

*NOTE: Electrical outputs specs only apply to reclocking SFP modules (3405T13-R & 3406Tx/yy-2)

Standard:	SMPTE 2082 (12Gb/s),SMPTE ST 424M (3Gb/s),SMPTE ST 292M (1.5Gb/s),SMPTE ST 259M (270Mb/s),DVB-ASI
Connector:	HD-BNC
Equalization:	Automatic to 35m @ 12Gb/s, 80m @ 3Gb/s, 100m @1.5Gb/s, 250m @ 270Mb/s (with Belden 1694A or equivalent)
Return Loss:	> 15dB up to 1.5GHz > 10dB up to 3GHz

2.6. ELECTRICAL OUTPUTS

*NOTE: Electrical outputs specs only apply to reclocking SFP modules (3406R-2 & 3406R-DA4R)

Voltage:	Auto-ranging 100–240V AC, 50/60Hz
Max. Power Consumption:	60W
Status Indicators:	Power supply status LEDs (each per power supply)
Connector:	HD-BNC
Signal Level:	800mV (nominal)
DC Offset:	0V +/- 0.5V
Rise and Fall Time:	12G: < 50ps HD/3G: < 135ps SD: < 900ps
Overshoot:	< 10% of amplitude
Return Loss:	> 15dB to 1.5GHz > 10dB to 3GHz
Alignment Jitter:	< 0.2UI to 1.485Gb/s, < 0.3UI to 2.97Gb/s, < 0.3UI to 11.88Gb/s

2.7. PHYSICAL

Physical:	SFP form-factor
Dimensions:	1.8" H x 19" W x 8" D
Module Capacity:	16x Evertz SFP modules, 4x MSA-compliant SFP modules
Operating Temperature:	0–50°C (with 3406FAN installed)

2.8. COMPLIANCE

Laser Safety:	Class 1 laser product, Complies with 24 CFR 1040.10 and 1040.11, IEC 60825–1
EMI/RFI:	Complies with FCC part 15, Class A Complies with EU EMC directives

3. INSTALLATION

The 3406FR-HDBNC frames require 1 rack unit (i.e. 1.75 inches (45 mm) of standard 19 inch (483 mm) wide rack space). To firmly fasten the frame to the equipment rack, make sure that all four mounting screws are securely tightened.

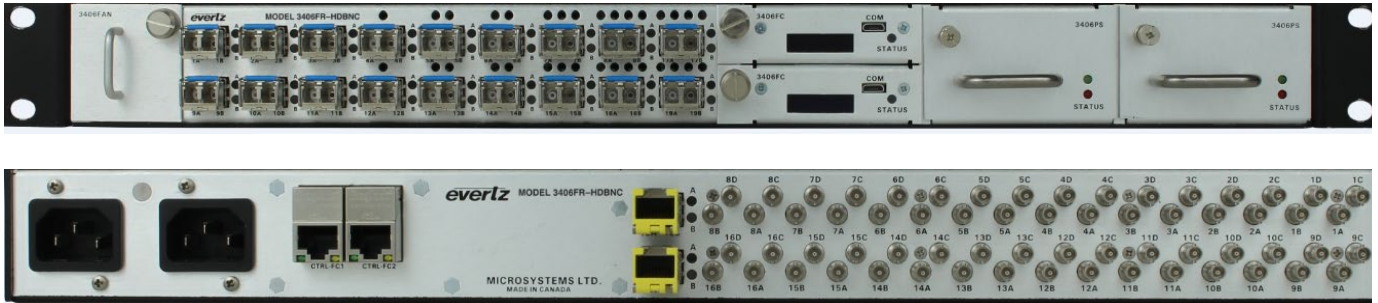

Figure 3-1: External Views of 3406FR-HDBNC

3.1. FAN INSTALLATION AND REMOVAL (3406FAN)

Figure 2-11 provides an illustration of the 3406FAN front view.

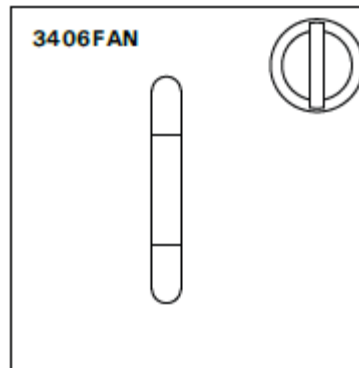

Figure 3-2: Front View of 3406FAN

3.1.1. Cooling

The 3406FR-HDBNC frame is designed to ensure adequate cooling for up to **60 Watts** of processing power per frame. Fans at the sides of the frame accomplish forced air cooling. Adjacent equipment may be mounted immediately to the top and bottom of the 3406FR-HDBNC frame. Additional module cooling is provided by interior cooling channels to ensure that even fully loaded frames mounted adjacent to each other will operate within the normal temperature range.

The 3406FAN module is capable of cooling the 3406FR from an operating ambient temperature of 0-50°C.

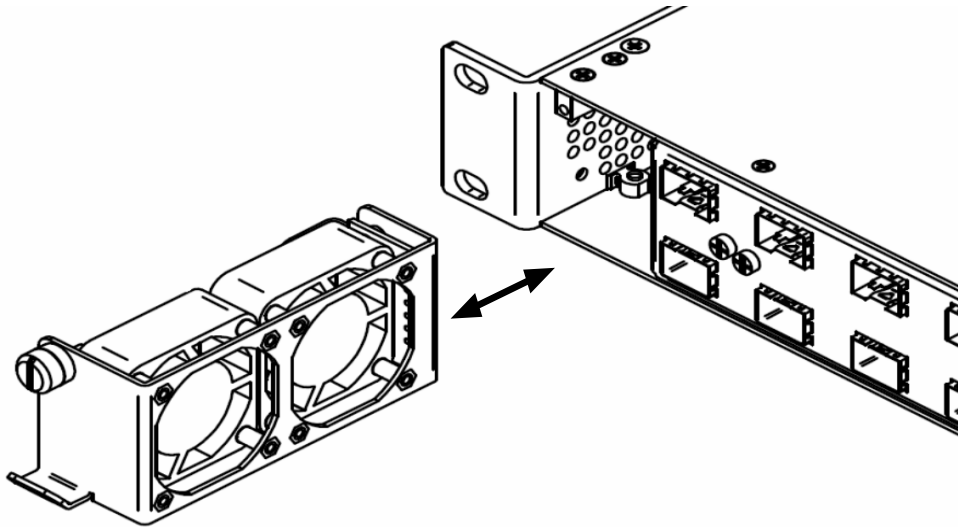

Figure 3-3: Cooling Fan Installation and Removal

If necessary, the cooling fans can be removed for the purposes of fan replacement. Always ensure that this procedure is applied while the frame is off. Removing the fans will cause unwanted heat build-up in the 3406FR. Undo the captive screw and pull outwards on the metal tab at the bottom of the 3406FAN. Installation is the reverse of removal.



CAUTION: To achieve adequate cooling, care should be taken to ensure that the fan inlets and exhaust openings are free of obstructions.

3.2. CARE AND HANDLING OF OPTICAL FIBER

3.2.1. Safety



CLASS 1 LASER PRODUCT

3.2.2. Assembly

Assembly or repair of the Evertz® SFP modules is done only at Evertz facility and performed only by qualified Evertz technical personnel.

3.2.3. Labeling

Certification and Identification labels are combined into one label. As there is inadequate space on the product to place the label, it is reproduced here in the manuals.

- There is no date of manufacture on this label as it can be traced by bar code label placed on the Evertz® SFP module.
- The model number of the SFPs containing lasers is one of: 3406T13-2, 3406Txx/yy-2, 3406R-2, 3406-DA4R, 3405T13-2, 3405Txx/yy-2, 3405R-2, 3405R-2R, 3405OO13-DA4 and 3405OOxx-DA4.
- where xx and yy = 27, 29, 31, 33, 35, 37, 39, 41, 43, 45, 47, 49, 51, 53, 55, 57, 59, 61.
- XX/YY versions include the following: 27/29, 31/33, 35/37, 39/41, 43/45, 47/49, 51/53, 55/57, 59/61



Figure 3-4: Reproduction of Laser Certification and Identification Label

3.2.4. Handling and Connecting Fibers



Never touch the end face of an optical fiber. Always keep dust caps on optical fiber connectors when not connected and always remember to properly clean the optical end face of a connector before making a connection.

The transmission characteristics of the fiber are dependent on the shape of the optical core and therefore care must be taken to prevent fiber damage due to heavy objects or abrupt fiber bending. Evertz recommends that the user maintains a minimum bending radius of 5 cm to avoid fiber-bending loss that will decrease the maximum attainable distance of the fiber cable. For further information about care and handling of fiber optic cable see the Evertz website. (<http://www.evertz.com/resources/>)

3.3. FIBER INPUT AND OUTPUT CONNECTIONS

These connections are made using standard LC fiber connector ends on single mode fiber optic cable. There are a total of 18 dual SFP slots. There can be a mix of 32 fiber inputs or outputs on the 3406FR front panel. A high quality fiber optic cable such as Corning SMF-28 or suitable equivalents should be used for optimum performance. Compatible SFP modules currently come in four configurations: dual transmitters, dual receivers, reclocking transmitter, and reclocking receiver.

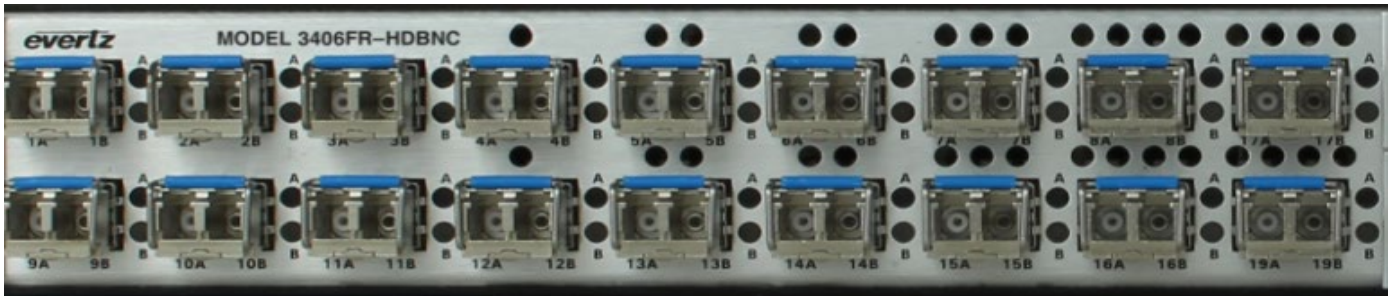

Figure 3-5: 3406FR-HDBNC Front View with Fiber Inputs and Outputs

Unpopulated SFP slots will remain inactive until the appropriate SFP is installed. Please ensure flat or ultra-flat polished fiber LC connectors are used for the SFPs.



NOTE: Channels A and B on the front of the 3406FR frame correspond to channels A and B on the rear of the frame (Figure 2-16).

Figure 2-15 depicts any one of the following Evertz® SFP modules: 3406T13-2, 3406Txx/yy-2, 3406R-2, , 3406-DA4R.



Figure 3-6: Evertz® SFP Modules

The SFP fiber modules are equipped with a class 1 laser and emit invisible radiation. Avoid exposure to the laser emitter and do not stare directly into unconnected SFP emitter ports or fiber ends that are connected to SFP ports.

- It is recommended that trained and qualified personnel install, replace or handle this equipment.
- Ensure ESD precautions are followed during SFP installation.
- Store SFP modules in static bags and wear an ESD strap when handling the optical modules. SFP modules are also dust sensitive.
- To prevent dust from entering the apertures of an SFP module, keep plugs inserted into the optical bores.
- Do not repeatedly remove and insert SFP modules more often than necessary. Repeated removals and insertions of an SFP module can shorten its life.

3.3.1. Electro Static Discharge (ESD) Precautions



All semiconductor devices are sensitive to ESD. To prevent any damage or degradation on components of the product caused by ESD, observe these precautions when installing or removing modules from the frame.

1. Discharge static from your body. Wear a grounded anti-static wrist or heel strap, to discharge the static voltage from your body.
2. Use a Safe Work Area. Avoid handling modules in areas that have a floor or work surface covering capable of generating a static charge. Also nothing capable of generating or holding a static charge should be allowed in the work area.
3. Handle ESD sensitive modules carefully. Do not slide modules over any surface. Do not touch exposed connector pins. Pick-up modules by the edges of the modules, never by touching exposed leads.
4. Transport and store sensitive components or assemblies in a static-protected bag or container.

3.3.2. 3406FR-HDBNC SFP Module Variants

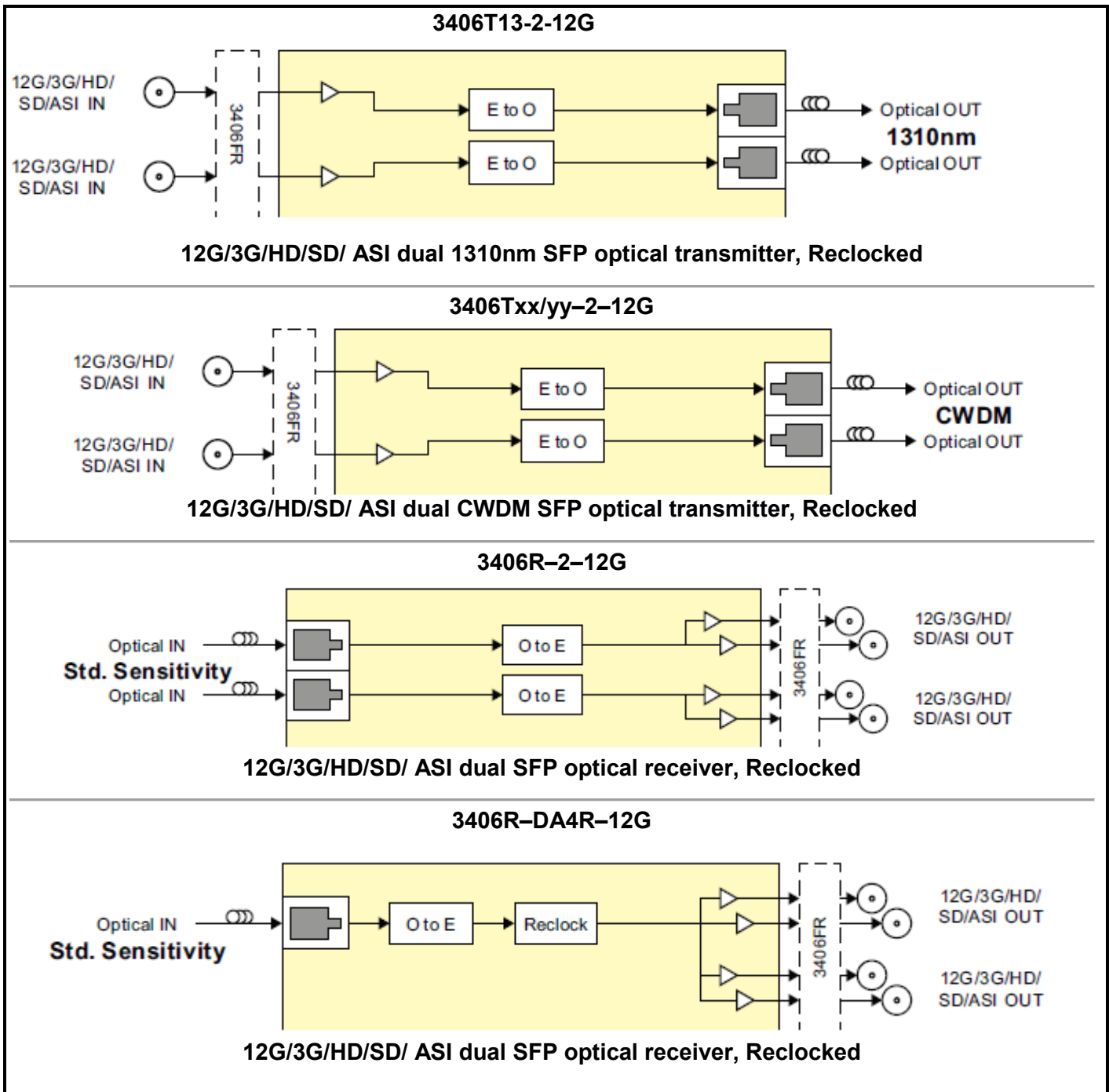

Figure 3-7: 3406FR-HDBNC SFP Module Variants

3.3.3. Installing an SFP Module



Note: In most cases, SFP modules will come from the factory preinstalled into its respective slot. The following steps outline the procedure for replacing or installing a new SFP module.

1. Remove the SFP module from its protective packaging. You can identify if your particular SFP module is a duplex transmitter or duplex receiver. Observe the top of the SFP module. The part number is located on the top of the SFP module. A 3406T13-2-part number denotes a duplex transmitter module and a 3406R-2 denotes a duplex receiver module. A 3406T13-2-part number denotes a relocking simplex transmitter module and a 3406R-DA4R denotes a relocking simplex receiver module (input).
2. Hold the sides of the SFP module between your thumb and forefinger, position the alignment grooves on the sides of the SFP with the corresponding guides in the SFP slot on your module.
3. Slide the SFP gently but firmly into the SFP slot. You should hear a click when the clips on either side of the SFP snap into place, locking the SFP in the port receptacle.



Note: Do not remove the dust plugs from the optical bores of the SFP or the dust caps from the fiber-optic cable until you are ready to connect the cable. The plugs and caps protect the SFP optical ports and the cable connectors from contamination.

3.3.4. Removing an SFP Module



Note: It is strongly recommended that SFP modules are not installed or removed with fiber-optic cables attached. Doing so may cause damage to the cables, the connectors, or the optical interfaces in the SFP module. Disconnect all cables before removing or installing SFP modules.

1. Pull the bale-clasp latch out and down to eject the module. If the latch is obstructed and you are not able to release the clasp, use a small flat-blade screwdriver or other narrow flat instrument to open the bale-clasp latch.
2. Grasp the SFP module between your thumb and index finger and carefully remove the SFP from its slot.
3. Place the removed SFP module into an anti-static bag, or other ESD protective container.

3.4. ELECTRICAL INPUT AND OUTPUT CONNECTIONS

3.4.1. Rear Panel HD-BNC Connections

The HD-BNC's on the rear of the 3406FR-HDBNC are fixed and correspond to a particular SFP module. These HD-BNC connectors are agile and thus configured as inputs or outputs. A HD-BNC will become an electrical input if its corresponding SFP spigot is an optical transmitter (Electrical to Optical converter). Conversely a HD-BNC will become an electrical output if its corresponding SFP spigot is an optical receiver (Optical to Electrical converter).

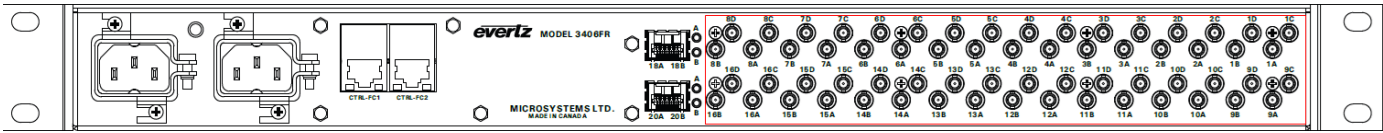

Figure 3-8: 3406FR-HDBNC Fixed Electrical Connections



NOTE: Channels A and B on the front of the 3405FR-HDBNC frame (Figure 2-14) correspond to channels A and B on the rear of the frame.

3.5. SERVICING INSTRUCTIONS



CAUTION – These servicing instructions are for use by qualified service personnel only. To reduce risk of electric shock do not perform any servicing instructions in this section of the manual unless you are qualified to do so.

3.6. CHANGING THE FUSES



If there is a fuse failure, contact Evertz customer service regarding the power supply immediately. The power supplies are short circuit protected and should not blow the fuse under a short circuit condition.

The fuse holders are located on the front of the power tray. To change the fuse for one of the supplies, you should first disconnect the power cord for the power supply. Insert a flat blade screwdriver in the fuse holder and turn clockwise. Pull out the fuse from the fuse holder using a small screwdriver. Remove the blown fuse and replace with a fuse of the correct value. The correct fuse rating is marked on the front panel. Carefully reinsert the fuse into the fuse holder. Tighten by turning the fuse holder counter clockwise.

The correct fuse rating is shown below.

Fuse Rating: 4 amps, 250 Volt time delay, 5 x 20 mm



Check that the line fuse is rated for the correct value. Never replace with a fuse of greater value.

4. STATUS AND LEDS

The 3406FC frame controller card is inserted through the front of the frame and is secured to the 3406FR frame with the one captive screws fastened on either side of the unit.

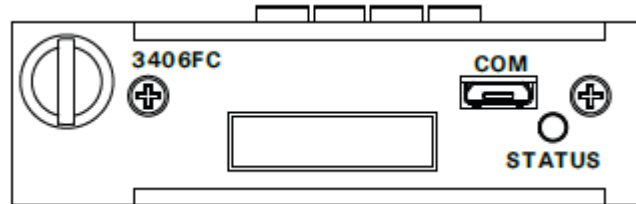

Figure 4-1: Front of 3406FC

4.1. STATUS LED

The two LEDs under the “STATUS” label on the front of the 3406FC identify the health of the frame and frame controller.

LED	Description
Red LED	<p>Red LED indicates failure of the power supply, fan or frame controller. The following parameters are monitored by the RED Status LED:</p> <ol style="list-style-type: none"> 1. 3406 Power Supply unit (blown fuse, short circuit condition) 2. Failure of the 3406FAN 3. Failure of 3406FC and 3406FC-2
Green LED	<p>Green LED frame, frame controller and power supplies are all functioning normally.</p>

Table 4-1: Status LED Chart

Page left intentionally blank

5. WEBEASY[®] CONFIGURATION

The 3406FR-HDBNC provides a built-in web interface that allows a user to interact with the 3406FR-HDBNC as well as supported 3406 SFPs using a standard web browser. The 3406FR-HDBNC web interface can be accessed by entering the IP address of the 3406FR-HDBNC into the address bar of an Internet web browser. When first visiting the 3406FR-HDBNC web interface, the user will be asked to enter a Login and Password.

Username: root
Password: evertz

Upon logging into the 3406FR-HDBNC, the user can navigate to the different configuration pages through the WebEASY sidebar (by default on the left hand side of the browser screen).



Figure 5-1: WebEasy[®] - Navigation Bar

The system page is used for checking product status, setting a device alias, and remotely rebooting the system or implementing a factory reset. Network management page can be used to configure network settings for the device and configure SNMP settings. Frame management is used to monitor the status of device components (fans). The SFP page is used to monitor and control the SFPs currently installed on the 3406FR-HDBNC. Notify is used to set trap destination IP addresses for monitoring.

5.1. SYSTEM

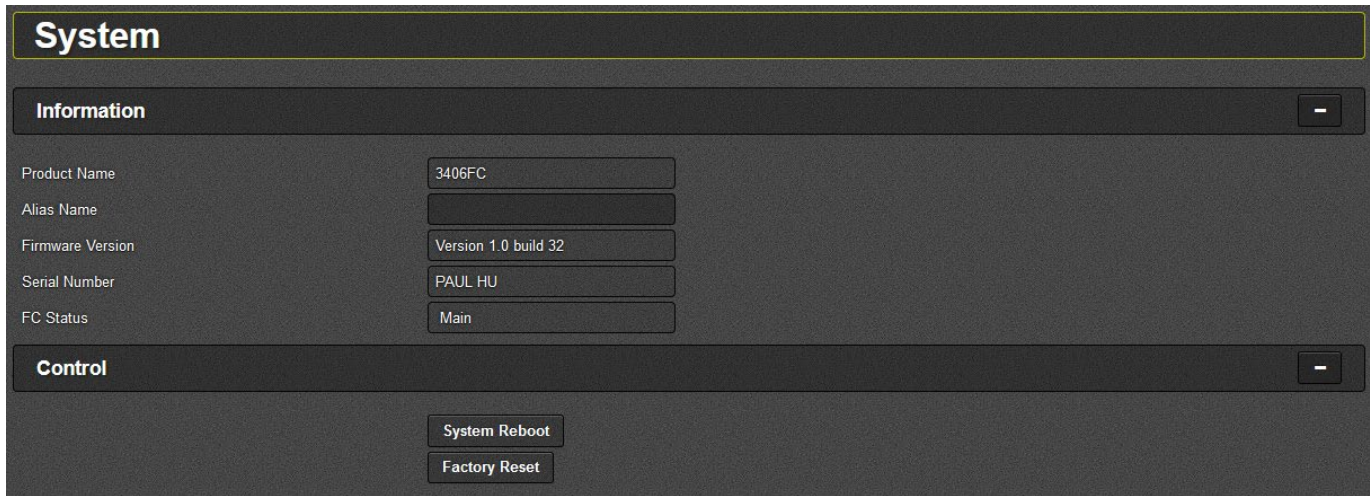

The screenshot shows a web interface for system configuration. At the top is a dark header with the word "System" in white. Below this is a section titled "Information" with a minus sign icon on the right. This section contains five rows of labels and text boxes: "Product Name" with the value "3406FC", "Alias Name" with an empty box, "Firmware Version" with the value "Version 1.0 build 32", "Serial Number" with the value "PAUL HU", and "FC Status" with the value "Main". Below the "Information" section is another section titled "Control" with a minus sign icon on the right. This section contains two buttons: "System Reboot" and "Factory Reset".

Figure 5-2: WebEasy® - System

Product Name: This field displays the name of the product.

Alias Name: This field allows the user to set an alias for this device.

Firmware Version: This field displays the firmware build current installed on the frame controller.

Serial Number: This field displays the serial number of the frame controller.

FC Status: This field displays the status of the frame controller.

System Reboot: This button will reboot the frame.

Factory Reset: This button will restore settings to factory default.

5.2. NETWORK MANAGEMENT

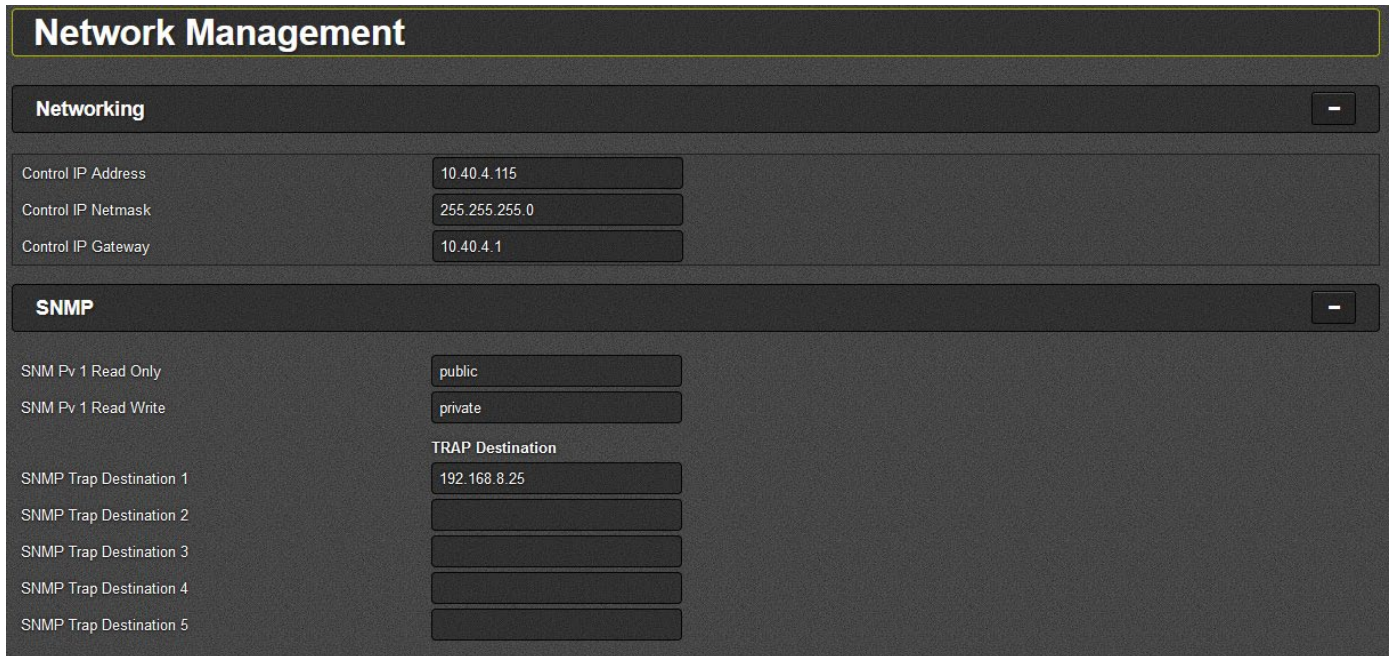

Figure 5-3: WebEasy® - Network Management

Networking

Control IP Address: This field allows the user to set the IP address of the control port.

Control IP Netmask: This field allows the user to set the IP netmask of the control port.

Control IP Gateway: This field allows the user to set the IP gateway of the control port.

SNMP

SNMP Pv 1 Read Only: This field allows the user to set the SNMP Pv1 read only community string.

SNMP Pv 1 Write: This field allows the user to set the SNMP Pv1 write community string.

SNMP Trap Destination 1-5: This allows the user to set an IP address for TRAP destination for up to 5 destinations.

5.3. FRAME MANAGEMENT

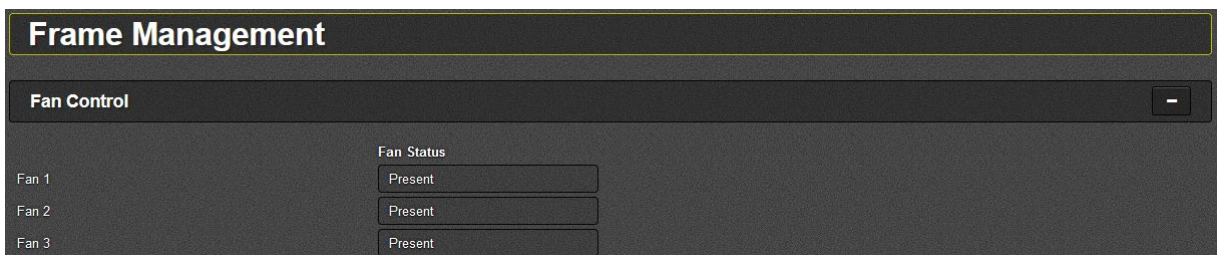

Figure 5-4: WebEasy® - Frame Management

Fan 1-3: These fields displays the status of fans 1-3.

5.4. SFP

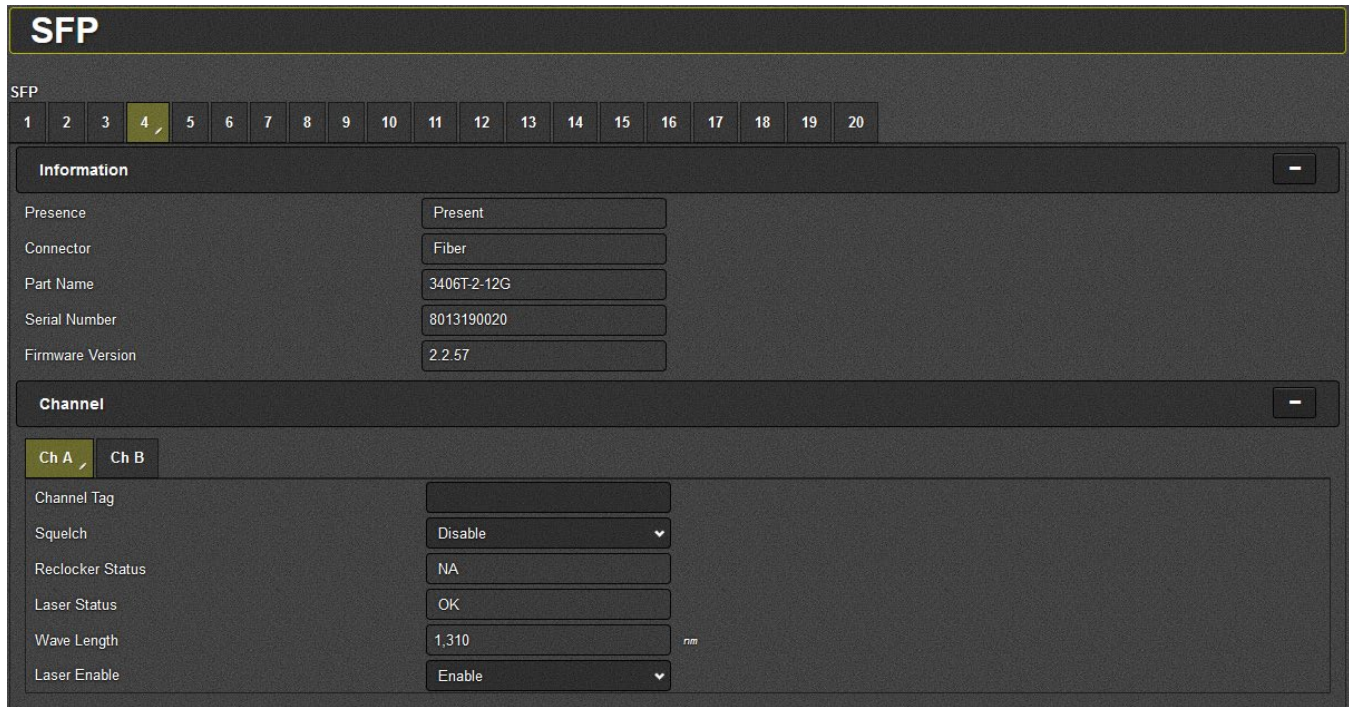

Figure 5-5: WebEasy® - SFP

Information

SFP: This control allows the user to select SFPs in port 1-20.

Presence: This field displays if there is a working SFP present on this port.

Connector: This field displays if a fiber or copper SFP is connected

Part Name: This field displays the part name of the SFP in this port.

Serial Number: This field displays the serial number for the SFP in this port.

Firmware Version: This field displays the firmware version installed on the SFP on this port.

Channel:

This section displays the control and monitoring options available for the SFP. User can select Channel A and Channel B. Some SFPs will use both channels while some will only use one of these.

Different menu options are available for the different 3406 SFPs connected to the frame. Sections 5.4.1 to 5.4.3 cover the options available for the SFPs shown.

5.4.1. SFP – 3406T-2-12G

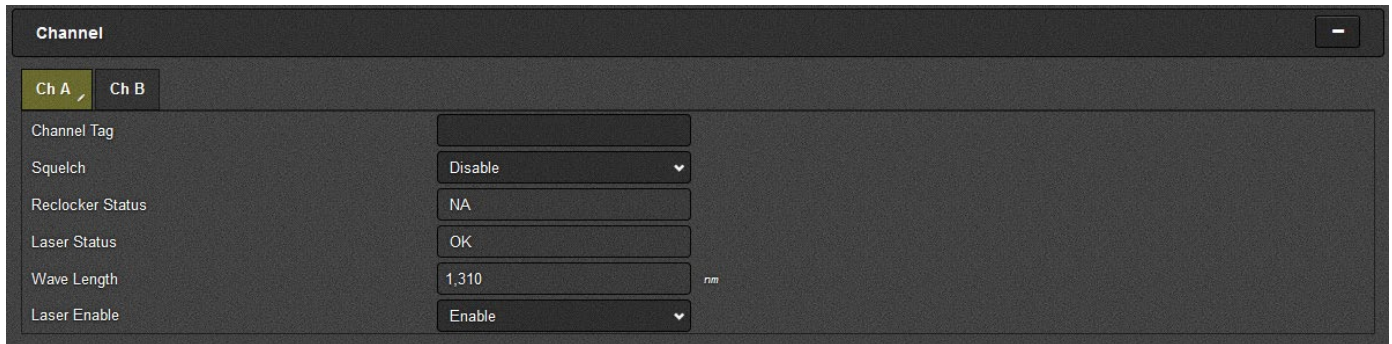

Figure 5-6: WebEasy® - SFP – 3406T-2-12G

This SFP has both Ch A and Ch B available

Channel Tag: This field allows the user to set a tag for each channel on the SFP.

Squelch: Enable/disable squelch on this channel of the SFP.

Reclocker Status: Get signal rate status of reclocker.

Laser Status: Displays status of SFP laser for optical.

Wave Length: Displays wave length (in nm).

Laser Enable: Allows user to enable laser on SFP.

5.4.2. SFP - 3406R-DA4R-12G



Figure 5-7: WebEasy® - SFP - 3406R-DA4R-12G

Use Ch B for this SFP

Channel Tag: This field allows the user to set a tag for this SFP.

Optical Power: This field displays the optical power received by the SFP.

Reclocker Status: This field displays the signal status rate of the reclocker.

Optical Power Low Thres.: This sliding control allows the user to set the minimum threshold for optical power received by the SFP before triggering an alarm. Threshold from -39dB to 0dB.

5.4.3. SFP – 3406R-2-12G

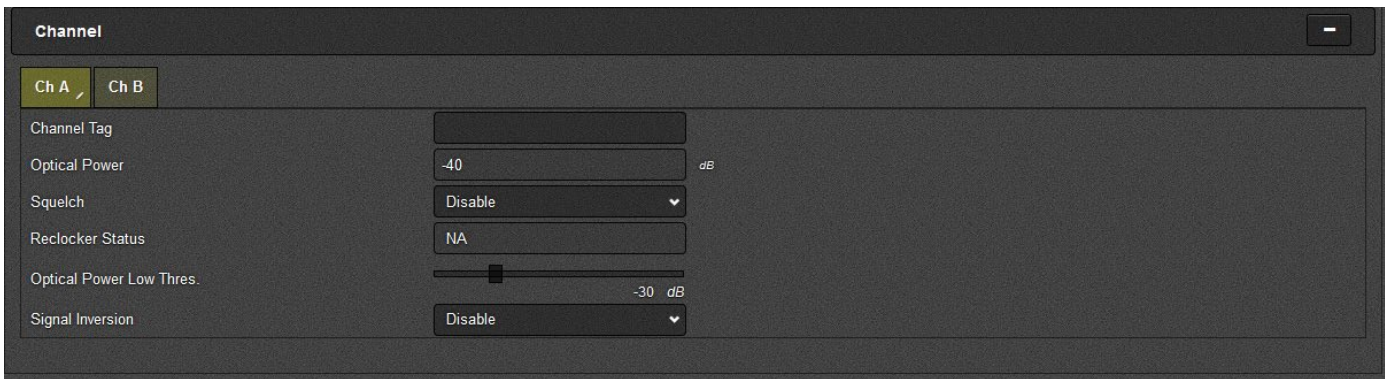

Figure 5-8: WebEasy® - SFP - 3406R-2-12G

Channel Tag: This field allows the user to set a tag for this SFP.

Optical Power: This field displays the optical power received by the SFP.

Squelch: Enable/disable squelch on this channel of the SFP.

Reclocker Status: This field displays the signal status rate of the reclocker.

Optical Power Low Thres.: This sliding control allows the user to set the minimum threshold for optical power received by the SFP before triggering an alarm. Threshold from -39dB to 0dB.

Note: Alarm must be enabled in order for low power threshold alarm to send.

Signal Inversion: Enabling signal inversion will reverse the polarity on the received signal.

5.5. NOTIFY

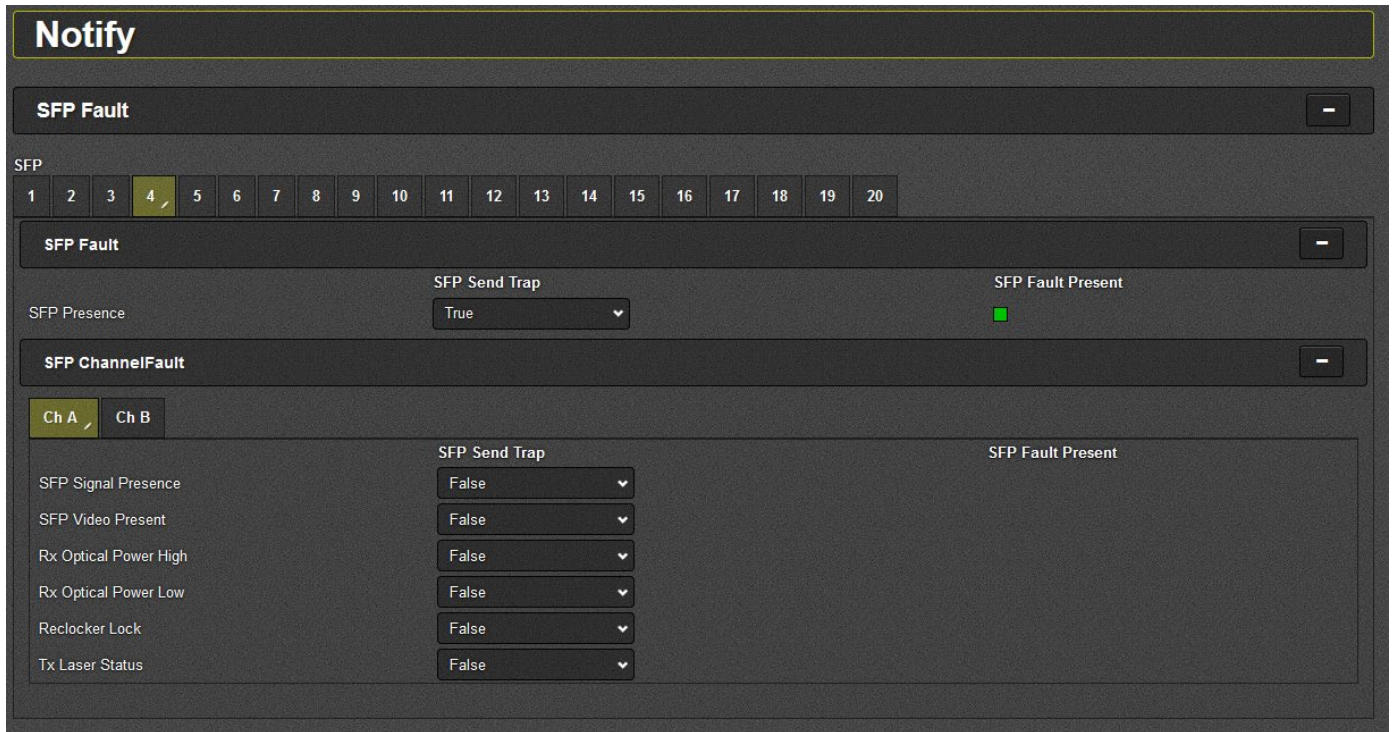

Figure 5-9: WebEasy® - Notify

SFP Fault

SFP: This control allows the user to select SFP located on ports 1-20.

SFP Send Trap: This control will enable sending trap for the fault indicated on this row.

SFP Fault Present: This indicator shows if there is a fault (red) or no fault (green).

SFP Presence: This notifies if a working SFP is detected on this port.

SFP ChannelFault:

Note: This section will only show the alarm options relevant for the SFP installed on that port. Figure 5-9 shows all of the notify options on the same image.

SFP Signal Presence: This notifies if the SFP is receiving signal on this channel.

SFP Video Presence: This notifies if the SFP is receiving video on this channel.

Rx Optical Power High: This notifies if the Rx high power threshold has been exceeded.

Rx Optical Power Low: This notifies if the Rx power is below the low power threshold.

Reclocker Lock: This notifies if the reclocker is in lock status.

Tx Laser Status: This notifies if there is a fault on the Tx laser.

This page left intentionally blank

6. 3406 SERIES CWDM PASSIVE OPTICAL MODULES

6.1. OVERVIEW

In fiber optic transmission systems, it is often necessary to split or combine optical signals. The 3406CWDM series passive CWDM mux/demux modules provide high capacity optical mux and demux for use with the 3406FR-HDBNC frames.

There are currently 8 modules in the passive optical module family.

MODEL	DESCRIPTION	FUNCTION
3406CWDM-M9	9 Channel Mux	Combines two of each of 1450nm to 1610nm onto two separate fibers.
3406CWDM-D9	Dual 9 Channel Demux	Separates two of each of 1450nm to 1610nm from two separate fibers.
3406CWDM-2-M9	Dual 9 Channel Mux	Combines 1450nm to 1610nm onto one separate fiber.
3406CWDM-2-D9	Dual 9 Channel Demux	Separates 1450nm to 1610nm from one separate fiber.
3406CWDM-M18	18 Channel Mux	Combines two of each of 1270nm to 1610nm onto two separate fibers.
3406CWDM-D18	18 Channel Demux	Separates two of each of 1270nm to 1610nm from two separate fibers.
3406CWDM-2-M18	Dual 18 Channel Mux	Combines 1270nm to 1610nm onto one separate fiber.
3406CWDM-2-D18	Dual 18 Channel Demux	Separates 1270nm to 1610nm from one separate fiber.

Table 6-1: Passive Optical Modules

6.1.1. 3406CWDM Coarse Wavelength Division Multiplexor

The 3406CWDM's are bi-directional Multiplexors/De-multiplexors that combine or separate up to 2 times Eighteen different wavelengths over two optical fibers.

The 3406CWDM is available in the following versions:

3406CWDM-M9	9-channel mux, 1450-1610nm
3406CWDM-D9	9-channel demux, 1450-1610nm
3406CWDM-2-M9	Dual 9-channel mux, 1450-1610nm
3406CWDM-2-D9	Dual 9-channel demux, 1450-1610nm
3406CWDM-M18	18-channel mux, 1270-1610nm
3406CWDM-D18	18-channel demux, 1270-1610nm
3406CWDM-2-M18	Dual 18-channel mux, 1270-1610nm
3406CWDM-2-D18	Dual 18-channel demux, 1270-1610nm

Features:

- Bi-directional mux/demux of up to 18 wavelengths in the 1470nm to 1610nm spectrum (ITU-T G.694.2 compliant)
- Passive design for any bit rate
- Low insertion loss to conserve system power
- High optical isolation for low crosstalk
- Fully hot-swappable from front of frame with minimal fiber disconnect/reconnect
- LC/PC connector option
- Fiber protector to prevent connector damage

6.2. INSTALLATION

The 3406 series optical CWDM modules are for use with the 3406FR-BNC frame. The multiplexing and demultiplexing can be grouped into 9 or 18 channels over 1 fiber.

The 9 channels wavelengths include the following wavelengths:

1450nm
1470nm
1490nm
1510nm
1530nm
1550nm
1570nm
1590nm
1610nm

The 18 channel wavelengths include the following wavelengths:

1270nm
1290nm
1310nm
1330nm
1350nm
1370nm
1390nm
1410nm
1430nm
1450nm
1470nm
1490nm
1510nm
1530nm
1550nm
1570nm
1590nm
1610nm

Connection from output lasers of the 3406FR SFP's to the input of the Mux requires a series of MTP to LC/UPC breakout cables.

The 9 channel break out cable is for use with the 9 channel modules, and the 18 channel break out cable is for use with the 18 channel modules.

MODEL	DESCRIPTION	REQUIRED FANOUT CABLE
3406CWDM-M9	9-channel mux, 1450-1610nm	1 X CB-MTP45CM-LCPC-9
3406CWDM-D9	9-channel demux, 1450-1610nm	1 X CB-MTP45CM-LCPC-9
3406CWDM-2-M9	Dual 9-channel mux, 1450-1610nm	2 X CB-MTP45CM-LCPC-9
3406CWDM-2-D9	Dual 9-channel demux, 1450-1610nm	2 X CB-MTP45CM-LCPC-9
3406CWDM-M18	18-channel mux, 1270-1610nm	1 X CB-MTP45CM-LCPC-18
3406CWDM-D18	18-channel demux, 1270-1610nm	1 X CB-MTP45CM-LCPC-18
3406CWDM-2-M18	Dual 18-channel mux, 1270-1610nm	2 X CB-MTP45CM-LCPC-18
3406CWDM-2-D18	Dual 18-channel demux, 1270-1610nm	2 X CB-MTP45CM-LCPC-18

Table 6-2: 3406CWDM Model and The Associated Required Fanout Cable



Note:

For 9 channel breakout cable, use Evertz Part number: CB-MTP45CM-LCPC-18
 For 18 channel breakout cable, use Evertz Part number: CB-MTP45CM-LCPC-9

End of document