



570ACO-X19-10G Series Quick Reference Guide

© Copyright 2020

EVERTZ MICROSYSTEMS LTD.

5292 John Lucas Drive
Burlington, Ontario
Canada L7L 5Z9

Phone:	+1 905-335-3700	
Sales:	sales@evertz.com	Fax: +1 905-335-3573
Tech Support:	service@evertz.com	Fax: +1 905-335-7571
Web Page:	http://www.evertz.com	



Version 1.0, June 2020

The material contained in this manual consists of information that is the property of Evertz Microsystems and is intended solely for the use of purchasers of the 570ACO-X19-10G series product. Evertz Microsystems expressly prohibits the use of this manual for any purpose other than the operation of the 570ACO-X19-10G series product. Due to on going research and development, features and specifications in this manual are subject to change without notice.

All rights reserved. No part of this publication may be reproduced without the express written permission of Evertz Microsystems Ltd. Copies of this manual can be ordered from your Evertz dealer or from Evertz Microsystems.

This page left intentionally blank

IMPORTANT SAFETY INSTRUCTIONS

	The lightning flash with arrowhead symbol within an equilateral triangle is intended to alert the user to the presence of uninsulated “Dangerous voltage” within the product’s enclosure that may be of sufficient magnitude to constitute a risk of electric shock to persons.
	The exclamation point within an equilateral triangle is intended to alert the user to the presence of important operating and maintenance (Servicing) instructions in the literature accompanying the product.

- Read these instructions
- Keep these instructions.
- Heed all warnings.
- Follow all instructions.
- Do not use this apparatus near water
- Clean only with dry cloth.
- Do not block any ventilation openings. Install in accordance with the manufacturer’s instructions.
- Do not install near any heat sources such as radiators, heat registers, stoves, or other apparatus (including amplifiers) that produce heat.
- Do not defeat the safety purpose of the polarized or grounding-type plug. A polarized plug has two blades with one wider than other. A grounding-type plug has two blades and a third grounding prong. The wide blade or the third prong is provided for your safety. If the provided plug does not fit into your outlet, consult an electrician for replacement of the obsolete outlet.
- Protect the power cord from being walked on or pinched particularly at plugs, convenience receptacles and the point where they exit from the apparatus.
- Only use attachments/accessories specified by the manufacturer
- Unplug this apparatus during lightning storms or when unused for long periods of time.
- Refer all servicing to qualified service personnel. Servicing is required when the apparatus has been damaged in any way, such as power-supply cord or plug is damaged, liquid has been spilled or objects have fallen into the apparatus, the apparatus has been exposed to rain or moisture, does not operate normally, or has been dropped.

WARNING

TO REDUCE THE RISK OF FIRE OR ELECTRIC – SHOCK, DO NOT EXPOSE THIS APPARATUS TO RAIN OR MOISTURE

WARNING

DO NOT EXPOSE THIS EQUIPMENT TO DRIPPING OR SPLASHING AND ENSURE THAT NO OBJECTS FILLED WITH LIQUIDS ARE PLACED ON THE EQUIPMENT

WARNING

TO COMPLETELY DISCONNECT THIS EQUIPMENT FROM THE AC MAINS, DISCONNECT THE POWER SUPPLY CORD PLUG FROM THE AC RECEPTACLE

WARNING

THE MAINS PLUG OF THE POWER SUPPLY CORD SHALL REMAIN READILY OPERABLE

INFORMATION TO USERS IN EUROPE

NOTE

CISPR 22 CLASS A DIGITAL DEVICE OR PERIPHERAL

This equipment has been tested and found to comply with the limits for a Class A digital device, pursuant to the European Union EMC directive. These limits are designed to provide reasonable protection against harmful interference when the equipment is operated in a commercial environment. This equipment generates, uses, and can radiate radio frequency energy and, if not installed and used in accordance with the instruction manual, may cause harmful interference to radio communications. Operation of this equipment in a residential area is likely to cause harmful interference in which case the user will be required to correct the interference at his own expense.

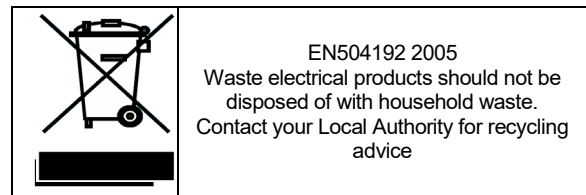
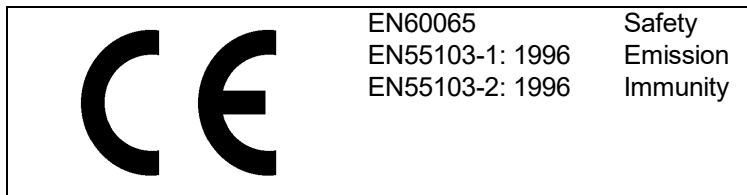

INFORMATION TO USERS IN THE U.S.A.

NOTE

FCC CLASS A DIGITAL DEVICE OR PERIPHERAL

This equipment has been tested and found to comply with the limits for a Class A digital device, pursuant to Part 15 of the FCC Rules. These limits are designed to provide reasonable protection against harmful interference when the equipment is operated in a commercial environment. This equipment generates, uses, and can radiate radio frequency energy and, if not installed and used in accordance with the instruction manual, may cause harmful interference to radio communications. Operation of this equipment in a residential area is likely to cause harmful interference in which case the user will be required to correct the interference at his own expense.

WARNING

Changes or Modifications not expressly approved by Evertz Microsystems Ltd. could void the user's authority to operate the equipment.

Use of unshielded plugs or cables may cause radiation interference. Properly shielded interface cables with the shield connected to the chassis ground of the device must be used.

REVISION HISTORY

<u>REVISION</u>	<u>DESCRIPTION</u>	<u>DATE</u>
1.0	First Release	Jun 2020

Information contained in this manual is believed to be accurate and reliable. However, Evertz assumes no responsibility for the use thereof nor for the rights of third parties, which may be affected in any way by the use thereof. Any representations in this document concerning performance of Evertz products are for informational use only and are not warranties of future performance, either expressed or implied. The only warranty offered by Evertz in relation to this product is the Evertz standard limited warranty, stated in the sales contract or order confirmation form.

Although every attempt has been made to accurately describe the features, installation and operation of this product in this manual, no warranty is granted nor liability assumed in relation to any errors or omissions unless specifically undertaken in the Evertz sales contract or order confirmation. Information contained in this manual is periodically updated and changes will be incorporated into subsequent editions. If you encounter an error, please notify Evertz Customer Service department. Evertz reserves the right, without notice or liability, to make changes in equipment design or specifications.

This page left intentionally blank

TABLE OF CONTENTS

1.	OVERVIEW	1
2.	SPECIFICATIONS.....	3
2.1.	SERIAL DIGITAL VIDEO.....	3
2.2.	IP INPUT.....	3
2.3.	SERIAL VIDEO OUTPUT	3
2.4.	IP OUTPUT	3
2.5.	SWITCHING REFERENCE.....	3
2.6.	ELECTRICAL	3
2.7.	PHYSICAL.....	4
2.8.	ENCLOSURES	4
2.9.	ORDERING INFORMATION.....	4
3.	GETTING STARTED	5
3.1.	FRONT PLATE	5
3.2.	BACK PLATE	6
3.3.	CARE AND HANDLING OF OPTICAL FIBER.....	7
3.4.	HARDWARE INSTALLATION	7
3.5.	570ACO-X19-10G INPUT/OUTPUT MAPPING	8
3.5.1.	App A Input/output mapping.....	8
3.5.2.	App B Input/output mapping.....	8
4.	WEB INTERFACE	9
4.1.	SYSTEM TAB.....	11
4.1.1.	Control Port Configuration	11
4.1.2.	Data Port Configuration	11
4.1.3.	Data Port Monitor.....	12
4.1.4.	SFP Monitor.....	13
4.1.5.	External Reference Monitor	13
4.1.6.	Genlock Control.....	14
4.1.7.	Inband Control	14
4.1.8.	RPC Timeout	14
4.1.9.	Time Management.....	15
4.1.10.	Configuration Management.....	15
4.1.11.	Card Control	15
4.2.	PRODUCT FEATURES	16
4.2.1.	Product Features	16
4.2.2.	License Control.....	16
4.3.	ACS CONTROL.....	17
4.3.1.	ACS Status	17

4.3.2. Input Control	17
4.3.3. Failover Control	17
4.3.4. Output Control	18
4.4. ACS CRITERIA.....	18
4.4.1. Video Monitoring Control	19
4.4.2. Audio Monitoring Control	20
4.4.3. Audio Monitoring Per Group	21
4.4.4. Audio Monitoring Per Channel	21
4.4.5. ANC Monitoring Control.....	22
4.5. SDI CONTROL	23
4.5.1. SDI Output Control	23
4.5.2. SDI Output Monitoring	23
4.5.3. VPID Monitoring	24
4.6. VIDEO (S2110-20) IP OUTPUT	24
4.6.1. IP Output Control.....	24
4.6.2. IP Output Advanced Control	25
4.6.3. IP Output Monitoring.....	25
4.7. VIDEO(S2110-20) IP INPUT	26
4.7.1. Global Control.....	26
4.7.2. IP Input Control.....	26
4.7.3. IP Input Monitoring.....	27
4.7.4. IP Input IGMP Control.....	27
4.8. AUDIO (S2110-30) IP OUTPUT	28
4.9. AUDIO (S2110-30) IP INPUT	29
4.10. ANC (S2110-40) IP OUTPUT.....	30
4.11. ANC (S2110-40) IP INPUT.....	30
4.12. PTP CONTROL	31
4.12.1. PTP Control.....	31
4.12.2. PTP Monitor.....	32
4.13. VIDEO NOTIFY.....	33
4.14. AUDIO NOTIFY	33
4.14.1. Audio Monitoring Control	33
4.14.2. Audio Failover Notify.....	34
4.14.3. Audio Stream Notify.....	34
4.14.4. Audio Channel Notify	35
4.15. ANC NOTIFY	35
4.16. NOTIFY.....	36
4.16.1. Board Notify.....	36
4.16.2. Decapsulator Fault.....	36
4.16.3. ACS Fault	36
4.16.4. Clear Faults	37

4.17. SNMP TRAP37

5. FIRMWARE UPGRADE39

5.1. FIRMWARE UPGRADE USING WEBEASY®39

5.2. FIRMWARE UPGRADE THROUGH VISTALINK PRO41

Figures

Figure 1-1: 570ACO-X19-10G App A Block Diagram 2

Figure 1-2: 570ACO-X19-10G App B Block Diagram 2

Figure 3-1: 570ACO-X19-10G Front Plate 5

Figure 3-2: 570ACO-X19-10G Back Plate 6

Figure 4-1: WebEASY® - Login In Menu 9

Figure 4-2: WebEASY® - Top Navigation Bar 10

Figure 4-3: WebEASY® - Side Menu 10

Figure 4-4: WebEASY® - System/Control Port Configuration 11

Figure 4-5: WebEASY® - System/Data Port Configuration 11

Figure 4-6: WebEASY® - System/Data Port Configuration 12

Figure 4-7: WebEASY® - System/SFP Monitor 13

Figure 4-8: WebEASY® - System/External Reference Monitor 13

Figure 4-9: WebEASY® - System/Genlock Control..... 14

Figure 4-10: WebEASY® - System/In-Band Control 14

Figure 4-11: WebEASY® - System/RPC Timeout..... 14

Figure 4-12: WebEASY® - System/Time Management 15

Figure 4-13: WebEASY® - System/Configuration Management..... 15

Figure 4-14: WebEASY® - System/Card Control 15

Figure 4-15: WebEASY® - License Control/Product Features..... 16

Figure 4-16: WebEASY® - ACS Status/ACS Control 17

Figure 4-17: WebEASY® - ACS Status/Input Control..... 17

Figure 4-18: WebEASY® - ACS Status/Failover Control..... 17

Figure 4-19: WebEASY® - ACS Status/Output Control..... 18

Figure 4-20: WebEASY® - ACS Criteria/Video Monitoring Control 19

Figure 4-21: WebEASY® - ACS Criteria/Audio Monitoring Control 20

Figure 4-22: WebEASY® - ACS Criteria/Audio Monitoring Per Group 21

Figure 4-23: WebEASY® - ACS Criteria/Audio Monitoring Per Channel..... 21

Figure 4-24: WebEASY® - ACS Criteria/ANC Monitoring Control..... 22

Figure 4-25: WebEASY® - SDI Control/SDI Output Control..... 23

Figure 4-26: WebEASY® - SDI Control/SDI Output Monitoring..... 23

Figure 4-27: WebEASY® - SDI Control/VPID Monitoring 24

Figure 4-28: WebEASY® - Video(S2110-20)IP Output/IP Output Control..... 24

Figure 4-29: WebEASY® - Video(S2110-20)IP Output/IP Output Advanced Control 25

Figure 4-30: WebEASY® - Video(S2110-20)IP Output/IP Output Monitoring 25

Figure 4-31: WebEASY® - Video(S2110-20)IP Input/Global Control 26

Figure 4-32: WebEASY® - Video(S2110-20)IP Input/IP Input Control 26

Figure 4-33: WebEASY® - Video(S2110-20)IP Input/IP Input Monitoring..... 27

Figure 4-34: WebEASY® - Audio(S2110-30)IP Output Tab 28

Figure 4-35: WebEASY® - Audio(S2110-30)IP Input Tab 29

Figure 4-36: WebEASY® - ANC(S2110-40)IP Output Tab..... 30

Figure 4-37: WebEASY® - ANC(S2110-40)IP Input Tab..... 30

Figure 4-38: WebEASY® - PTP Control/PTP Control..... 31

Figure 4-39: WebEASY® - PTP Control/PTP Monitor 32

Figure 4-40: WebEASY® - Video Notify Tab 33

Figure 4-41: WebEASY® - Audio Notify/Audio Monitoring Control..... 33

Figure 4-42: WebEASY® - Audio Notify/Audio Failover Notify 34

Figure 4-43: WebEASY® - Audio Notify/Audio Stream Notify	34
Figure 4-44: WebEASY® - Audio Notify/Audio Channel Notify.....	35
Figure 4-45: WebEASY® - ANC Notify	35
Figure 4-46: WebEASY® - Notify/ Board Notify.....	36
Figure 4-47: WebEASY® - Notify /Decapsulator Fault	36
Figure 4-48: WebEASY® - Notify/ ACS Notify /ACS Fault.....	36
Figure 4-49: WebEASY® - Notify/ ACS Notify/ Clear Faults.....	37
Figure 4-50: WebEASY® - SNMP Trap/SNMP Trap	37
Figure 5-1: WebEASY® - Upgrade Button on Top Menu Bar	39
Figure 5-2: WebEASY® - Firmware Upgrade Menu	39
Figure 5-3: WebEASY® - Firmware Upgrade Menu	40
Figure 5-4: VistaLINK Pro/Version Information	41
Figure 5-5: VistaLINK Pro/Upgrade Firmware	42
Figure 5-6: VistaLINK Pro/Upgrade Logon	42
Figure 5-7: VistaLINK Pro/ Upgrade completed.....	42

1. OVERVIEW

The 570ACO-X19-10G is an auto clean switch designed for auto failover of SMPTE 2110 signals due to Video faults, Audio Faults or Data faults with selectable priority for each input signal. The 570ACO-X19-10G contains 3 independent cores with 4x SMPTE 2110 inputs (A,B,C,D) with the capability of producing 2X SMPTE 2110 and HDSDI outputs from each core (Program & Preview).

Monitoring capabilities include the ability to detect HDSDI errors. Parameters include frozen Video detection, black video detection, picture and audio level monitoring as well as Ancillary Data monitoring. Many of these parameters have user-adjustable thresholds and time periods to suit any application.

Features & Benefits

Signal Flow

- SMPTE 2022-7 on all 2110 main/backup inputs
- Settable frame delay up to 14 frames per video path (audio and ANC follow video)
- Support slipless mode to auto-sync videos from different inputs.
- Program and Preview outputs can be manually overridden by the customer to select any input.
- Clean video switch. No TRS violations on video output.
- Quiet audio switch. No pops.

Controls

- Full in-band control support for Magnum routing
- VGPI support from Magnum
- Priority setting for input failover
- Can force disable an input to exclude it
- Revertible and non-revertible failover
- A fault reported can be included or excluded in the failover decision making
- Can function 4x1, 3x2, 3x1 and 2x1 ACS by disabling unused inputs/outputs.
- Failover faults:
 - Frozen video
 - Video missing
 - Audio missing
 - Audio silence
 - Closed caption missing
 - SCTE104 missing

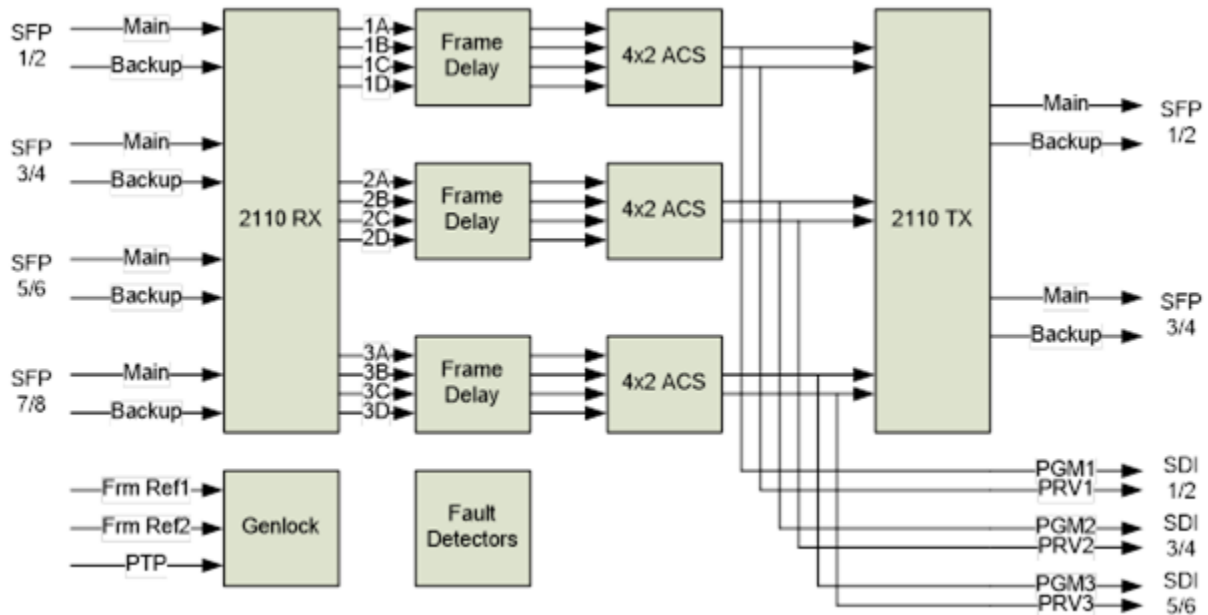

Figure 1-1: 570ACO-X19-10G App A Block Diagram

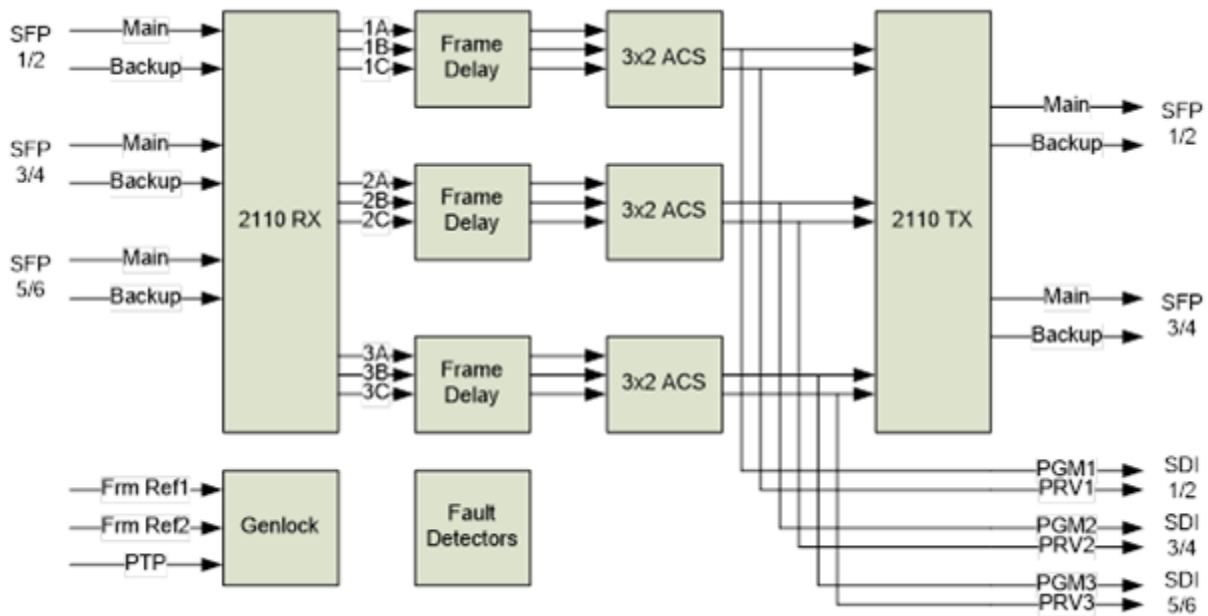

Figure 1-2: 570ACO-X19-10G App B Block Diagram

2. SPECIFICATIONS

2.1. SERIAL DIGITAL VIDEO

- SMPTE 424M (3Gb/s)
- SMPTE 292M (1.5Gb/s)

2.2. IP INPUT

Ethernet Interface: 8x 10GE SFP+(App A), 6x10GE SFP+(App B)
Decapsulation: SMPTE2110

2.3. SERIAL VIDEO OUTPUT

Standards:

App A: STMPE 424M (3Gb/s), STMPE 292M (1.5Gb/s)

App B: STMPE 292M (1.5Gb/s)

Number of Outputs: 6
Connector: DIN
Signal Level: 800mV nominal
DC Offset: 0V ±0.5V
Return Loss: >12 dB up to 1.5GHz

2.4. IP OUTPUT

Ethernet Interface: 4x 10GE SFP+ (AppA & B)
Encapsulation: SMPTE2110

2.5. SWITCHING REFERENCE

Reference Input: 2x BNC on 570FR
Analog 525/625
PTP(IEEE1588–2008) via 10GbE interface

2.6. ELECTRICAL

Voltage: +12VDC
Power: 90 Watts
EMI/RFI: Complies with FCC regulations for class A devices
Complies with EU EMC directive

2.7. PHYSICAL

Number of slots: 2

2.8. ENCLOSURES

S570FR: 3RU chassis
570FR: 1RU chassis

2.9. ORDERING INFORMATION

570ACO-X19-10G Automatic change over with Audio / Video monitoring. 10GE I/O and SDI outputs. (SFP+ sold separately)

3. GETTING STARTED

The 570ACO-X19-10G comes with a companion rear plate and occupies one slot in 570FR. Refer to Figure 3-1 for 570ACO-X19-10G front plate layout and Figure 3-2 for the 570ACO-X19-10G rear plate layout.

3.1. FRONT PLATE

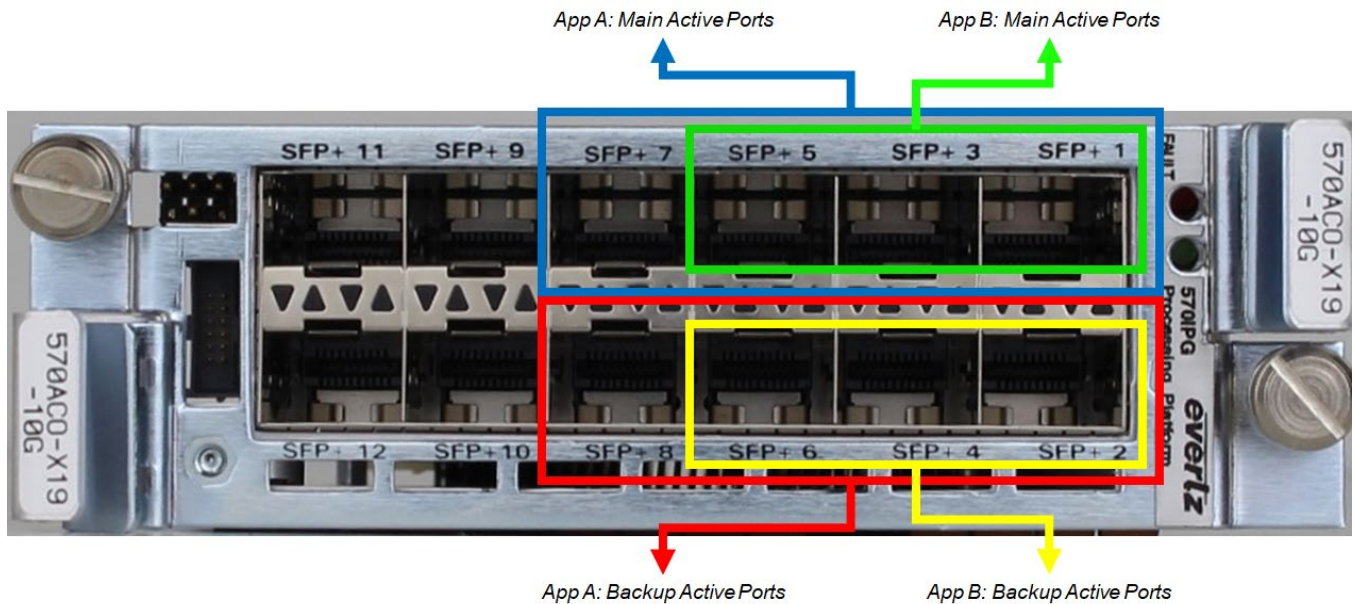

Figure 3-1: 570ACO-X19-10G Front Plate

The front of the 570ACO-X19-10G has following connections

- 12xSFPs ports capable of passing 10Gb of data per port.
 - For **App A**: SFP1 to SFP8 are used:
 - **Main Active Ports**: SFP1, SFP3, SFP5, SFP7
 - **Backup Active Ports**: SFP2, SFP4, SFP6, SFP8
 - For **App B**: SFP1 to SFP8 are used:
 - **Main Active Ports**: SFP1, SFP3, SFP5
 - **Backup Active Ports**: SFP2, SFP4, SFP6



Note: Currently SFP9 to SFP12 are disabled and reserved for future use.

3.2. BACK PLATE

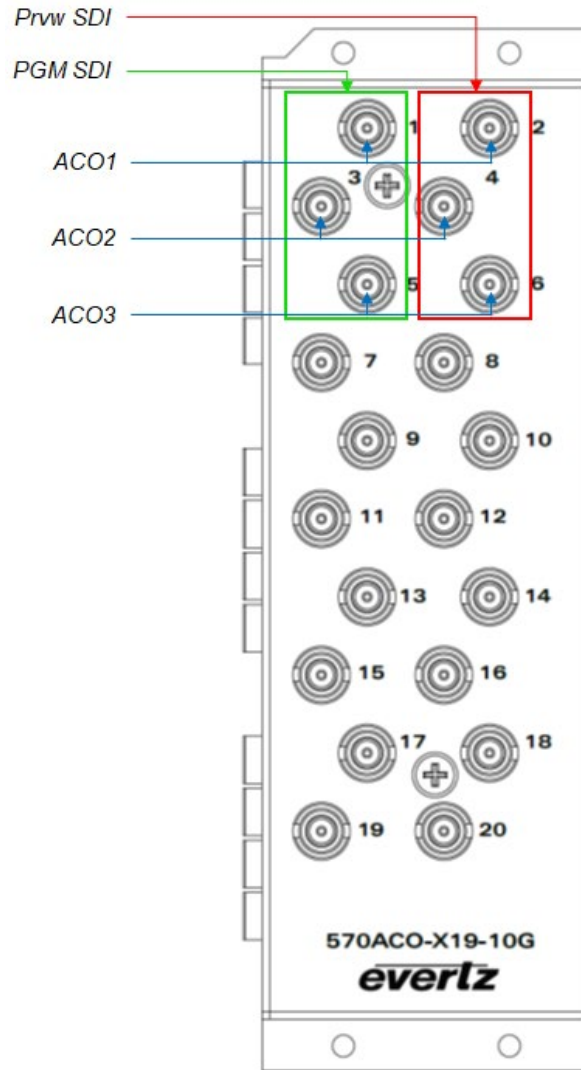

Figure 3-2: 570ACO-X19-10G Back Plate



The back of the 570ACO-X19-10G has following connections:

- 20 mini din connectors, only first 6 dins are used for ACO1, ACO2, ACO3
 - Din 1 for **PGM SDI** output and Din 2 for **Prvw SDI** output for **ACO core 1**
 - Din 3 for **PGM SDI** output and Din 4 for **Prvw SDI** output for **ACO core 2**
 - Din 5 for **PGM SDI** output and Din 6 for **Prvw SDI** output for **ACO core 3**
- 2 BNCs for Reference
- 1 power supply

3.3. CARE AND HANDLING OF OPTICAL FIBER

The transmission characteristics of the fiber are dependent on the shape of the optical core and therefore care must be taken to prevent fiber damage due to heavy objects or abrupt fiber bending. Evertz recommends that the user maintains a minimum bending radius of 5 cm to avoid fiber bending loss that will decrease the maximum attainable distance of the fiber cable.



NOTE: Never touch the end face of an optical fiber. Always keep dust caps on optical fiber connectors when not connected and always remember to properly clean the optical end face of a connector before making a connection.

3.4. HARDWARE INSTALLATION

To successfully install the 570ACO-X19-10G, the following is required:

1. 570 Series Frame
2. 570 Frame Controller
3. Web browser using the 570FC frame controller with 570ACO-X19-10G installed in frame

Before handling the card, it is important to minimize the potential effects of static electricity. It is therefore recommended that an ESD strap be worn.

Locate on the chassis 2 adjacent vacant slots. Unpack the 570ACO-X19-10G and separate the rear panel from the main card. Locate on the rear of the rack the two slots and remove the blanking panels. Insert the rear panel into the back of the chassis and secure using the four screws provided.

Now insert the 570ACO-X19-10G card into the corresponding front slots ensuring the card lines up with the slot runners on the bottom and the top of the chassis. Push the card **firmly** into the slot ensuring that when it mates with the rear card it has been firmly pushed into a seated position. The card is secured to the frame with two thumb screws on the front. Hand tighten the thumb screws instead of using a screw driver to avoid over tightening.

This procedure can be completed on all the other modules. The cards are hot swappable allowing for the frame to be powered on while installing.

3.5. 570ACO-X19-10G INPUT/OUTPUT MAPPING

3.5.1. App A Input/output mapping

In total, 12 virtual SDIs (1A/1B/1C/1D, 2A/2B/2C/2D, 3A/3B/3C/3D) are converted from 2110 inputs. Each ACS does failover switching of input (A/B/C/D) and output 2 SDIs (PGM and PRV) and identical 2110 outputs.

<i>SFP Input</i>	<i>Virtual SDI Input</i>
SFP1&2	1A, 2A, 3A
SFP 3&4	1B, 2B, 3B
SFP 5&6	1C, 2C, 3C
SFP 7&8	1D, 2D, 3D

Table 3-1: 570ACO-X19-10G App A SMTPE 2110 Input Mapping

<i>SFP Input</i>	<i>Virtual SDI Input</i>
SFP1&2	1PGM, 2PGM, 3PGM
SFP 3&4	1PRV, 2PRV, 3PRV

Table 3-2: 570ACO-X19-10G App A SMTPE 2110 Output Mapping

3.5.2. App B Input/output mapping

In total, there are 9 virtual SDIs (1A/1B/1C, 2A/2B/2C, 3A/3B/3C) are converted from 2110 inputs. Each ACS does failover switching of input (A/B/C) and output 2 SDIs (PGM and PRV) and identical 2110 outputs.

<i>SFP Input</i>	<i>Virtual SDI Input</i>
SFP1&2	1A, 1B, 1C
SFP 3&4	2A, 2B, 2C
SFP 5&6	3A, 3B, 3C

Table 3-3: 570ACO-X19-10G App B SMTPE 2110 Input Mapping

<i>SFP Input</i>	<i>Virtual SDI Input</i>
SFP1&2	1PGM, 2PGM, 3PGM
SFP 3&4	1PRV, 2PRV, 3PRV

Table 3-4: 570ACO-X19-10G App B SMTPE 2110 Output Mapping

4. WEB INTERFACE

Different product licenses will enable different product features. Depending on the product features enabled, there will be different tabs and controls that will need to be configured. For the purpose of this Quick Reference Guide, we have enabled all product features.

After the card has been installed and configured with the required network addresses for the control ports, it can be completely configured using the web interface. To do this, simply type in the IP address of the **Control Port** on the 570ACO-X19-10G module in the web browser.



Note: We are assuming that the S570FR or 570FR frame is connected to the network and the computer is able to communicate to the frame on the Control Port IP address of the 570ACO-X19-10G



Figure 4-1: WebEASY[®] - Login In Menu

For login and password, type in “*customer*”.

Upon entering the correct credentials, the user will be directed to the main User Interface that displays the following information:

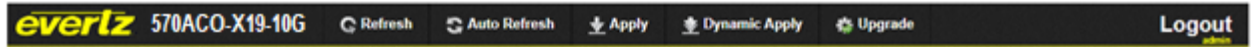

Figure 4-2: WebEASY® - Top Navigation Bar

- **Top Navigation Bar**
 - **Product Name:** Displays the product Name
 - **Refresh:** Manually refreshes the user’s configuration
 - **Auto Refresh:** Automatically refreshes the user’s configuration
 - **Apply:** Manually saves the user’s configuration
 - **Dynamic Apply:** Automatically saves the user’s configuration
 - **Upgrade:** Upgrade the Firmware’s version of the product
 - **Logout:** Logs the user out of the User Interface

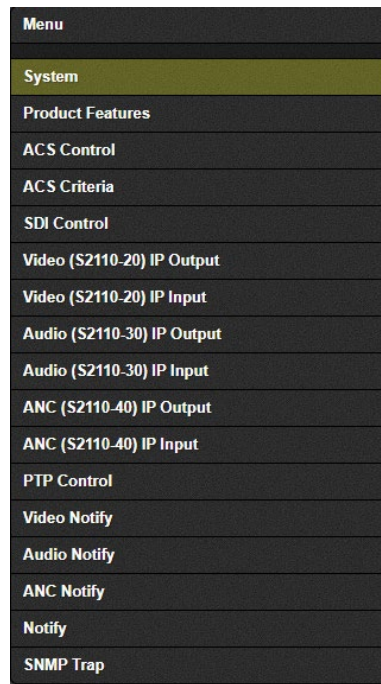

Figure 4-3: WebEASY® - Side Menu

- **Side Menu:** Displays a menu of all tabs the user is able to monitor/configure.
- **Main Tab:** Middle section of the interface, displays all the fields for the item selected from the side menu. These menu tabs and fields will be fully described in the following sections.



Due to the size of the certain menu tabs, screen tab images will be broken into multiple images. Some of the screen shots will also require the user to zoom in to see the image more clearly.

4.1. SYSTEM TAB

4.1.1. Control Port Configuration

Control Port Configuration	
Eth0	USB0
IP Address	192.168.8.70
Netmask	255.255.255.0
Gateway	192.168.8.1

Figure 4-4: WebEASY® - System/Control Port Configuration

Eth0

The Eth0 tab shows the control IP address of the 570ACO. This IP address is only used when installed inside a S570FR standalone frame. The 570ACO's Ethernet port is attached to the S570FR frame via a ribbon cable.

IP Address: This Parameter allows the user to set the control port's IP address.

Netmask: This Parameter allows the user to set the control port's Netmask.

Gateway: This parameter allows the user to set the control port's Gateway.

USB0

The USB0 tab shows the control IP address of the 570ACO. This IP address is used when installed inside a 570FR frame with a 570FC present. This IP address is set in the 570FC's webpage.

IP Address: This Parameter allows the user to view the control port's IP address.

Netmask: This Parameter allows the user to view the control port's Netmask.

Gateway: This parameter allows the user to view the control port's Gateway

4.1.2. Data Port Configuration

All data ports require unique IP addresses set. The Netmask and Gateway settings must also be set accordingly.

Data Port Configuration	
SFP	
1	2 3 4 5 6
IP Address	192.168.13.149
Netmask	255.255.255.0
Gateway	192.168.13.1

Figure 4-5: WebEASY® - System/Data Port Configuration

For SFP 1-6

IP Address: This parameter allows the user to set the data port's IP address.

Netmask: This parameter allows the user to set the data port's Netmask.

Gateway: This parameter allows the user to set the data port's Gateway.

4.1.3. Data Port Monitor

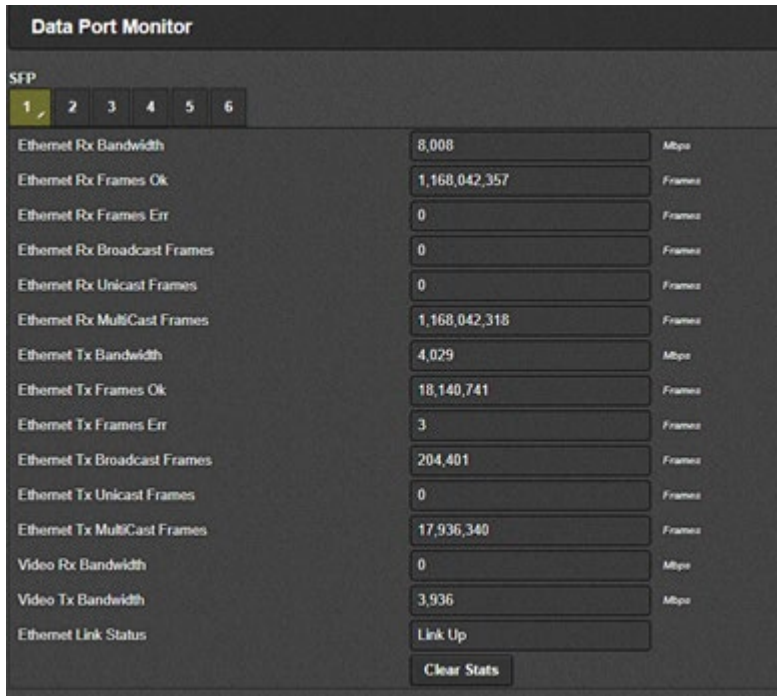

Figure 4-6: WebEASY® - System/Data Port Configuration

For SFP 1-6

Ethernet Rx Bandwidth: This field shows the received Ethernet bandwidth.

Ethernet Rx Frames OK: This field shows the number of Error-Free received frames.

Ethernet Rx Frames Err: This field shows the number of errored received frames.

Ethernet Rx Broadcast Frames: This field shows the number of broadcast frames received.

Ethernet Rx Unicast Frames: This field shows the number of unicast frames received.

Ethernet Rx Multicast Frames: This field shows the number of multicast frames received.

Ethernet Tx Bandwidth: This field shows the transmitted Ethernet bandwidth.

Ethernet Tx Frames OK: This field shows the number of error-free frames transmitted.

Ethernet Tx Frames Err: This field shows the number of errored frames transmitted.

Ethernet Tx Broadcast Frames: This field shows the number of broadcast frames transmitted.

Ethernet Tx Unicast Frames: This field shows the number of unicast frames transmitted.

Ethernet Tx Multicast Frames: This field shows the number of multicast frames transmitted.

Video Rx Bandwidth: This field shows the received video bandwidth.

Video Tx Bandwidth: This field shows the transmitted video bandwidth

Ethernet Link Status: This field shows the Ethernet port link status as “Link Up” or “Link Down”.

Clear Stats: This field allows the user to clear all the stats of the corresponding SFP Tab.

4.1.4. SFP Monitor



Figure 4-7: WebEASY® - System\SFP Monitor

For SFP 1-6

SFP Part Number: This parameter shows the part number of SFP installed.

SFP Type: This parameter shows the type of SFP installed.

SFP Rx Power level: This parameter shows the SFP's received power level.

SFP Tx Power level: This parameter shows the SFP's transmitted power level.

4.1.5. External Reference Monitor

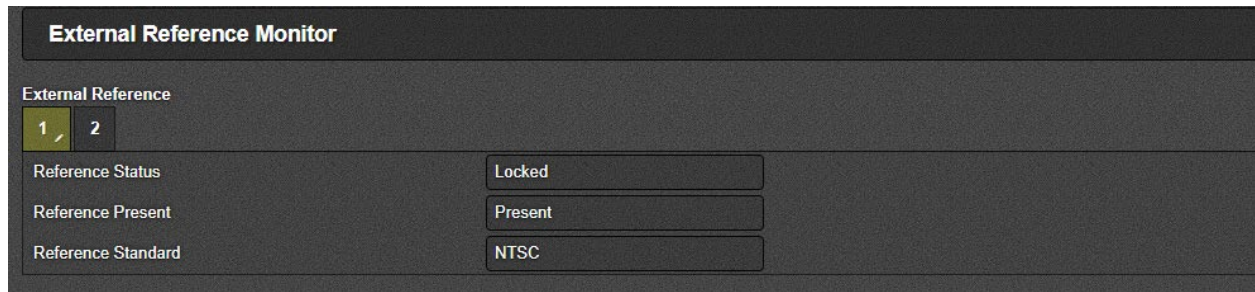

Figure 4-8: WebEASY® - System/External Reference Monitor

For External Reference 1 & 2

Reference Status: This field reports external reference lock status as “Locked” or “unlocked”.

Reference Present: This field reports if an external reference is present or absent.

Reference Standard: This field reports if an external reference standard is NTSC or PAL.

4.1.6. Genlock Control

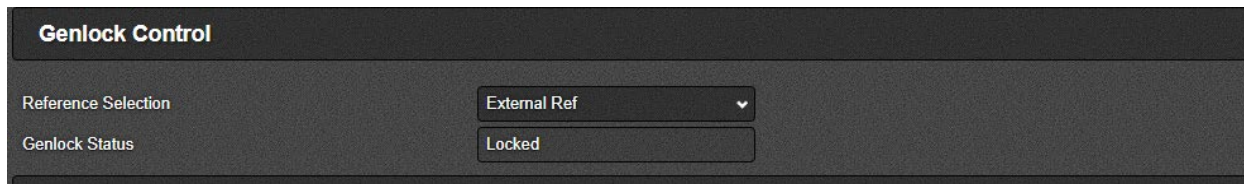

Figure 4-9: WebEASY® - System/Genlock Control

Reference Selection: This dropdown menu allows the user to select the output reference. Options can include the following depending on what type of firmware is loaded:

- External Ref
- Internal Ref
- PTP

Reference Status: This field indicates if the card is locked to the selected reference source.

4.1.7. Inband Control

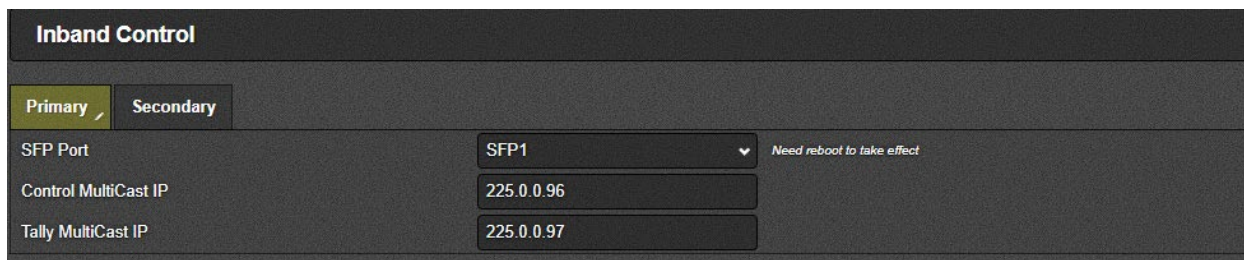

Figure 4-10: WebEASY® - System/In-Band Control

For SFP 1-6

SFP Port: This control allows the user to select which SFP port will be used for RPC control.

Control Multicast IP: This control allows the user to set a receive multicast IP address.

Tally Multicast IP: This control allows the user to set a tally multicast IP address.

4.1.8. RPC Timeout



Figure 4-11: WebEASY® - System/RPC Timeout

Timeout: This control allows the user to set an RPC timeout. The Default Value is 30,000ms. It's not recommended that you change this value.

4.1.9. Time Management

Figure 4-12: WebEASY® - System/Time Management

Time Source: This control allows the user to select between two time sources, “Local” & “NTP”.

Time zone Offset: This parameter allows the user to set different time zone.

Day Light Saving: This parameter allows the day light savings to be turned ON or Off.

Extern NTP Server: This parameter allows the user to enter the NTP server’s IP address.

4.1.10. Configuration Management

Figure 4-13: WebEASY® - System/Configuration Management

Export Configure File: The “Download” button allows the user to download & save the card’s current configuration on a local PC.

Import Configure File: This upload control allows the user to load a previously saved configuration file to the card.

4.1.11. Card Control

Figure 4-14: WebEASY® - System/Card Control

Card Alias: This text box allows the user to enter a custom card name which will be shown on the top left hand corner of the card’s webpage in yellow.

Purge Card: This control is used to clear all IP input/output settings on the card (Except control & data IPs) to default values as well as clear all routes present in the “Route Control” page. It’s recommended a card be purged before configuring it in MAGNUM SDVN for the first time.

Load Factory Config: Pressing this button results in the factory configuration being loaded on the card.

Reboot Card: This control is used to reboot the card.

4.2. PRODUCT FEATURES

4.2.1. Product Features

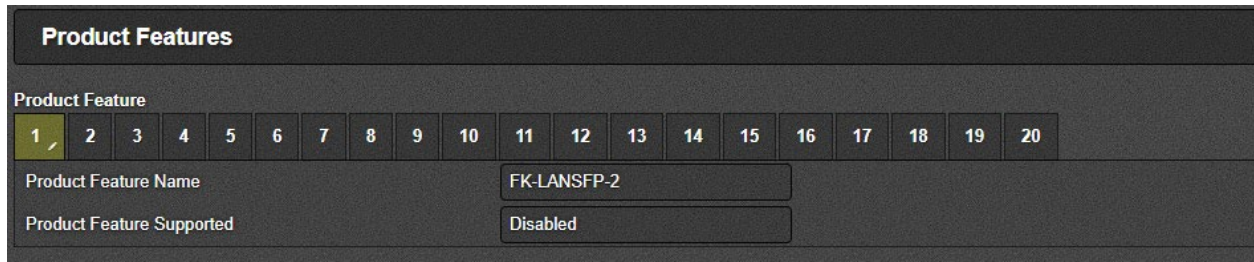

Figure 2-1: WebEASY® -Product Features/Product Features

For Product Features 1-20

Product Feature name: Product features which are supported on this card are listed here. All available product features are listed in different tabs.

Product Feature Supported: This parameter shows you if the listed product feature is enabled or disabled.

4.2.2. License Control



Figure 4-15: WebEASY® - License Control/Product Features

Export Product License File: Clicking the “Download” button allows the user to download the product license file “license.txt” to your PC.

Import Product License File: This control allows you to upload a product license file.

Product Serial Number: This parameter displays the card’s unique serial number.

Product MAC Address: This parameter displays the card’s unique MAC address.

4.3. ACS CONTROL

4.3.1. ACS Status



ACS Status	
Current PGM Output Source	B
Current Preview Output Source	C

Figure 4-16: WebEASY® - ACS Status/ACS Control

For Auto Clean Switch (ACS) 1-3

Current PGM Output Source: Show the current PGM output source i.e. input Stream A, B or C.

Current Preview Output Source: Show the current Preview output source i.e. input stream A, B or C.

4.3.2. Input Control



Input Control	
A Enable	Enable
B Enable	Enable
C Enable	Enable

Figure 4-17: WebEASY® - ACS Status/Input Control

(A-C) Enable: These controls allow the user to enable or disable Auto Clean Switch (ACS) individually.

4.3.3. Failover Control



Failover Control	
Revertive Mode	Disable
Priority 1	A
Priority 2	B
Priority 3	C

Figure 4-18: WebEASY® - ACS Status/Failover Control

Revertive Mode: This dropdown allows the user to Enable/Disable Revertive mode. If revertive mode is enable with priority 1-A and priority 2-B, currently PGM input source is B and then you route input stream A then current PGM source will be switched back to A.

Priority 1,2,3 : Priority can be given to the input streams for the failover. If User don't want to give priority to any stream then None option can be selected.

4.3.4. Output Control

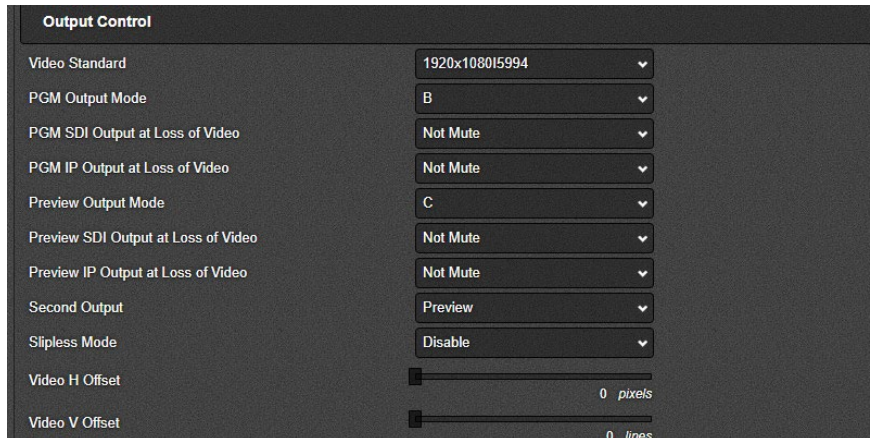

Figure 4-19: WebEASY® - ACS Status/Output Control

Video Standard: This dropdown menu allows the user to select the video standard.

PGM output Mode: This dropdown allows the user to set the PGM output mode i.e. IP input stream for PGM output either A,B,C or ACS.

PGM SDI Output at loss of video: This dropdown menu allows the user to set Program SDI Output to “mute” or “last frame” if the Input lost.

PGM IP Output at loss of video: This dropdown menu allows the user to set Program IP Output to “mute” or “last frame” if the Input lost.

Preview output Mode: This dropdown allows the user to set the Preview output mode i.e. IP Input Stream for Preview output either A,B,C or ACS.

Preview SDI Output at loss of video: This dropdown menu allows the user to set Preview SDI Output to “mute” or “last frame” if the Input lost.

Preview IP Output at loss of video: This dropdown menu allows the user to set Preview IP Output to “mute” or “last frame” if the Input lost.

Second Output: From this dropdown menu user can set second output to PGM or Preview.

Slipless mode: This dropdown menu allows the user to enable or disable Slipless mode. At slipless mode enable, ACO will auto align input streams. Even the input streams have screw between each streams, the ACO output should be smooth after switch.

Video H-Offset: With this control, user can set the horizontal timing of the output video with respect to reference.

Video V-offset: With this control, user can set the vertical timing of the output video with respect to reference.

4.4. ACS CRITERIA

Duration: User specified time that the input will come back within given time duration.

Timeout: This control allows the user to set a timeout length when Input signal is lost, once it's confirmed, the input stream no longer valid.



NOTE: Timeout period to be greater or equal to Duration period.

4.4.1. Video Monitoring Control

Video Monitoring Control		
Video Missing Failover	Enable	
Video Missing Duration	1	(1 to 1000) frames
Video Missing Timeout	1	(1 to 1000) frames
Video Freeze Failover	Enable	
Video Freeze Duration	1	(1 to 1000) frames
Video Freeze Timeout	1	(1 to 1000) frames
Video Packet Error Failover	Enable	
Video Packet Error Duration	1	(1 to 1000) frames
Video Packet Error Timeout	1	(1 to 1000) frames
Video Black Failover	Enable	
Video Black Duration	1	(1 to 1000) frames
Video Black Timeout	1	(1 to 1000) frames

Figure 4-20: WebEASY® - ACS Criteria/Video Monitoring Control

For ACS 1-3

Video Missing Failover: Using this dropdown menu user can enable/disable Failover when video is missing. If video missing Failover is disabled then there won't be any failover even video is missing.

Video Missing duration: This field allows to set Video Missing Duration between 1 to 1000 frames.

Video Missing Timeout: This field allows to set video missing timeout between 1 to 1000 frames.

Video Freeze Failover: Using this dropdown menu user can enable/disable Failover when video is frozen. On video freeze, failover will only happen if video freeze failover is enable.

Video Freeze duration: This field allows to set the video freeze duration between 1 to 1000 frames.

Video Freeze Timeout: This field allows to set video freeze timeout between 1 to 1000 frames.

Video Packet Error Failover: Using this dropdown menu user can enable/disable Failover when there is packet error. To get failover on video packet error video packet error should be enable.

Video Packet Error duration: This Field allows the user to set the video Packet Error duration between 1 to 1000 frames.

Video Packet Error Timeout: This field allows to set video packet error timeout between 1 to 1000 frames.

Video Black Failover: Using this dropdown menu user can enable/disable Failover when video is black. If video black failover is disabled, then failover won't happen if input video is black.

Video Black duration: This field allows to set Video Black Duration between 1 to 1000 frames.

Video Black Timeout: This field allows to set Video Black Timeout between 1 to 1000 frames.

4.4.2. Audio Monitoring Control

Audio Monitoring Control		
Audio Missing Duration	<input type="text" value="1"/>	(1 to 100000) ms
Audio Missing Timeout	<input type="text" value="1"/>	(1 to 100000) ms
Audio Silence Duration	<input type="text" value="1"/>	(1 to 100000) ms
Audio Silence Timeout	<input type="text" value="1"/>	(1 to 100000) ms
Audio Packet Error Duration	<input type="text" value="1"/>	(1 to 100000) ms
Audio Packet Error Timeout	<input type="text" value="1"/>	(1 to 100000) ms

Figure 4-21: WebEASY® - ACS Criteria/Audio Monitoring Control

For ACS 1-3

Audio Missing Duration: This field allows to set Audio Missing Duration between 1 to 100000ms.

Audio Missing Timeout: This field allows to set Audio Missing Timeout between 1 to 100000ms.

Audio Silence Duration: This field allows to set Audio Silence duration between 1 to 100000ms.

Audio Silence Timeout: This field allows to set Audio Silence Timeout between 1 to 100000ms.

Audio Packet Error Duration: This field allows to set Audio Packet Error Duration between 1 to 100000ms.

Audio Packet Error Timeout: This field allows to set Audio Packet Error Timeout between 1 to 100000ms.

4.4.3. Audio Monitoring Per Group

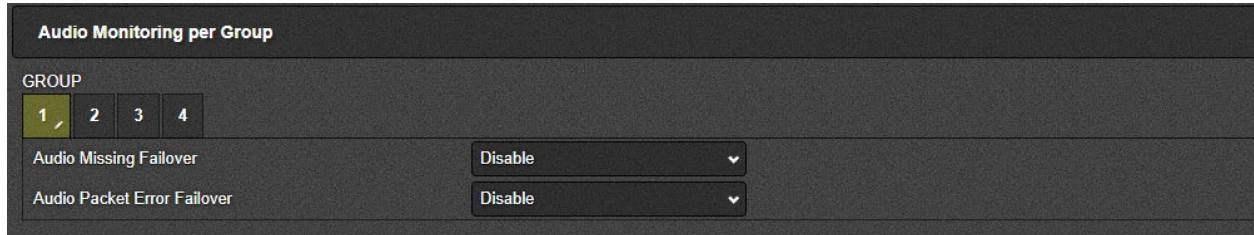

Figure 4-22: WebEASY® - ACS Criteria/Audio Monitoring Per Group

For Audio Groups 1-4

Audio Missing Failover: This control allows the user to enable/disable Failover when audio group is missing.

Audio Packet Error Failover: This control allows the user to enable/disable Failover when there is Audio Packet Error.

4.4.4. Audio Monitoring Per Channel

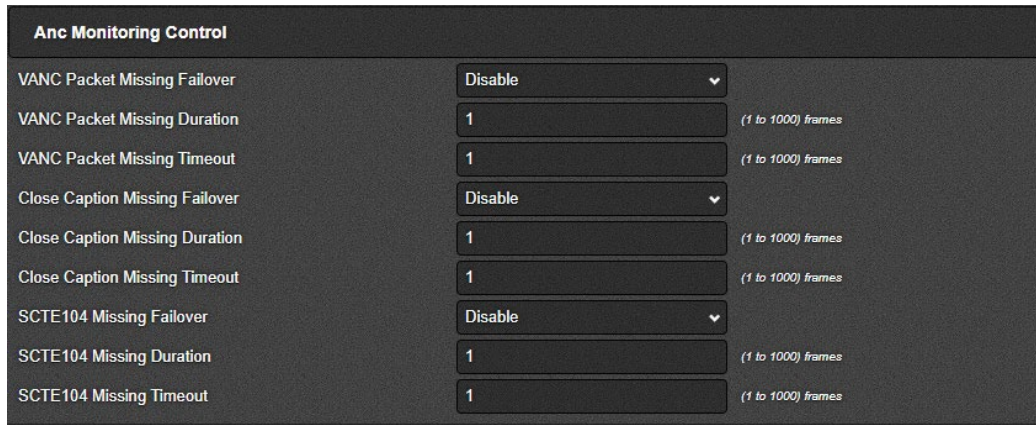

Figure 4-23: WebEASY® - ACS Criteria/Audio Monitoring Per Channel

For 16 Channels

Audio Silence Failover: This control allows to Enable/Disable Failover when Audio is Silent.

4.4.5. ANC Monitoring Control



Anc Monitoring Control		
VANC Packet Missing Failover	Disable	
VANC Packet Missing Duration	1	(1 to 1000) frames
VANC Packet Missing Timeout	1	(1 to 1000) frames
Close Caption Missing Failover	Disable	
Close Caption Missing Duration	1	(1 to 1000) frames
Close Caption Missing Timeout	1	(1 to 1000) frames
SCTE104 Missing Failover	Disable	
SCTE104 Missing Duration	1	(1 to 1000) frames
SCTE104 Missing Timeout	1	(1 to 1000) frames

Figure 4-24: WebEASY® - ACS Criteria/ANC Monitoring Control

VANC Packet Missing Failover: This control allows to Enable/Disable failover when VANC Packets are missing.

VANC Packet Missing Duration: This field allows to set VANC Packet Missing duration between 1 to 1000 frames.

VANC Packet Missing Timeout: This field allows to set VANC packet missing Timeout between 1 to 1000 frames.

Close Caption Missing Failover: This control allows to Enable/Disable Failover when Close Caption is missing.

Close Caption Missing Duration: This field allows to set Close Caption Missing duration between 1 to 1000 frames.

Close Caption Missing Timeout: This field allows to set Close Caption Missing Timeout between 1 to 1000 frames.

SCTE104 Missing Failover: This control allows the user to Enable/Disable Failover when SCTE104 missing.

SCTE104 Missing Duration: This field allows the user to set SCTE104 Missing Duration between 1 to 1000 frames.

SCTE104 Missing Timeout: This field allows the user to set SCTE104 Missing Timeout between 1 to 1000 frames.

4.5. SDI CONTROL

4.5.1. SDI Output Control

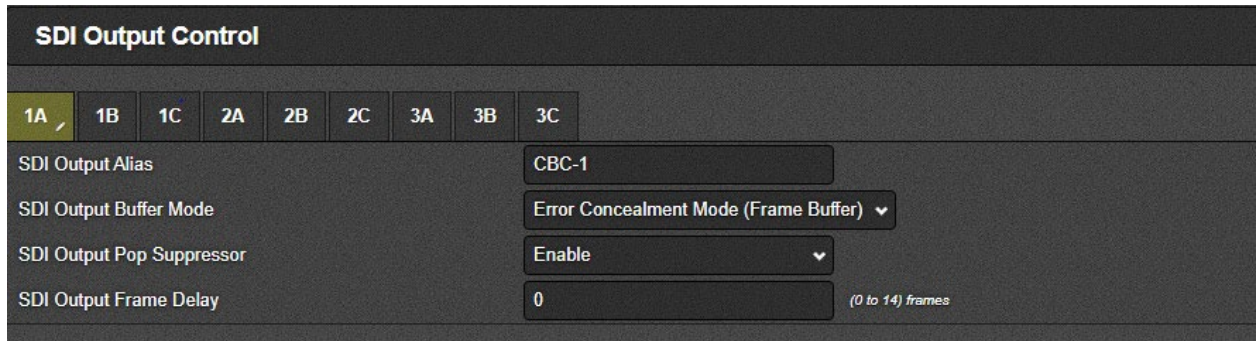

Figure 4-25: WebEASY® - SDI Control/SDI Output Control

For 1A to 3C

- A1, B1, C1 are the input streams for ACO1/ACS1;
- A2, B2, C2 are the input streams for ACO2/ACS2
- A3, B3, C3 are the input streams for ACO3/ACS3.

SDI Output Alias: In this field user can set the Alias for SDI Output.

SDI Output Buffer Mode: This dropdown menu allows the user to select the buffer mode (Low Latency/ Frame Buffer/Line Buffer) for SDI output.

SDI Output Pop Suppressor: This dropdown allows the user to Enable/Disable the Pop Suppressor.

SDI Output Frame Delay: In this field User can set Number of frames delay between 0 to 14 Frames.

4.5.2. SDI Output Monitoring



Figure 4-26: WebEASY® - SDI Control/SDI Output Monitoring

SDI Output Present: Shows SDI Output is Present(Locked) or Absent(Lost).

SDI Output Active Ethernet port: Shows active ethernet port for SDI output.

4.5.3. VPID Monitoring

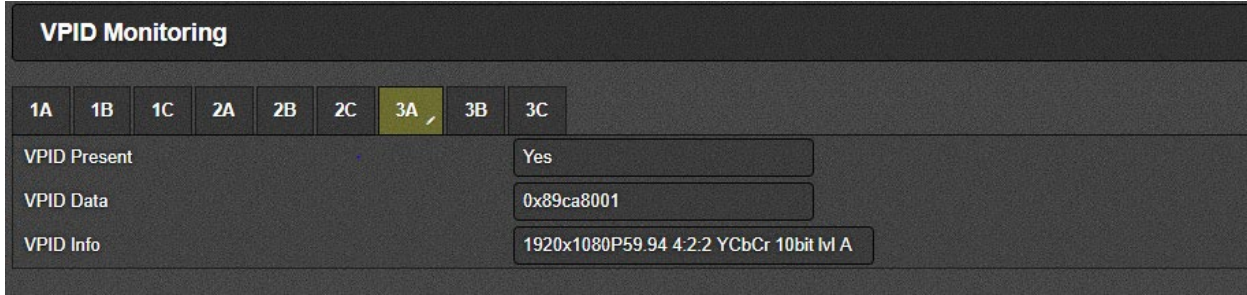

Figure 4-27: WebEASY® - SDI Control/VPID Monitoring

VPID Present: Shows that video Payload Id is preset or not.

VPID Data: This field shows VIPD’s data.

VPID Information: This field describe the information for the Video Payload ID.

4.6. VIDEO (S2110-20) IP OUTPUT

4.6.1. IP Output Control



Figure 4-28: WebEASY® - Video(S2110-20)IP Output/IP Output Control

For PGM 1 to 3 and Prvw 1 to 3

- *PGM:* Program outputs for ACO1/ACS1, ACO2/ACS2 and ACO3/ACS3 respectively.
- *Prvw:* Preview outputs for ACO1/ACS1, ACO2/ACS2 and ACO3/ACS3 respectively.

IP Output Status: This field indicates if IP output is enabled or disabled for Main and Back up path.

IP Output Destination IP Address: This field allows the user or control system to assign an output destination IP address.

IP Output Destination UDP Port: This field allows the user or control system to assign the output destination UDP Port.

4.6.2. IP Output Advanced Control

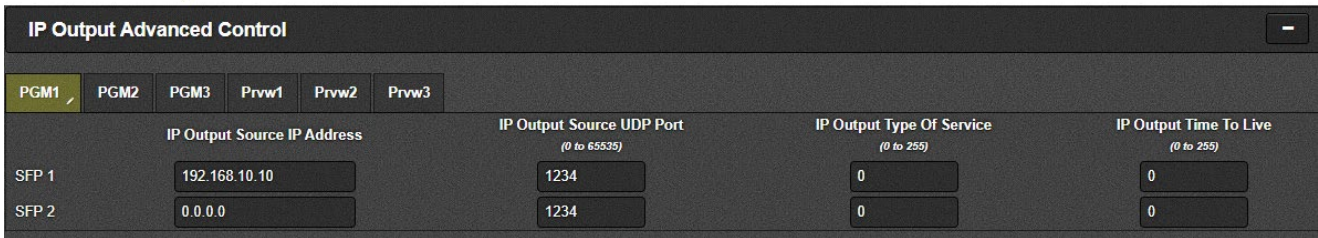

Figure 4-29: WebEASY® - Video(S2110-20)IP Output/IP Output Advanced Control

For PGM 1 to 3 and Prvw 1 to 3 (refer to 4.6.1 for details)

IP Output Source IP Address: This field allows the user or control system to assign the source IP address for the corresponding SFP port.

IP Output Source UDP Port: This field allows the user or control system to assign the source UDP port.

IP Output Type of Service: This field allows the user or control system to assign the type of service.

IP Output Time to Live: This field allows the user or control system to assign the output Time-to-live (TTL) value.

4.6.3. IP Output Monitoring

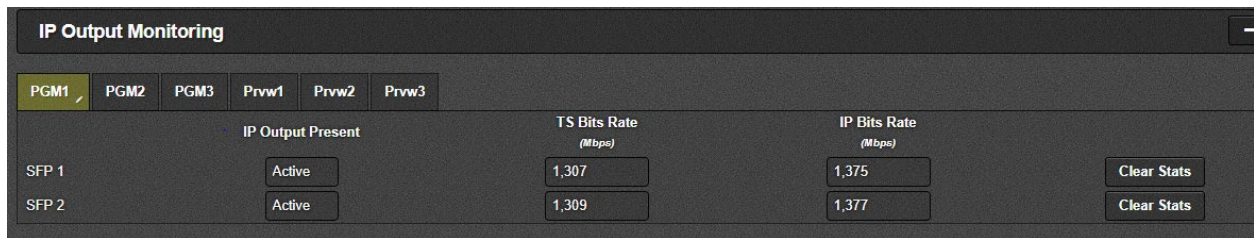

Figure 4-30: WebEASY® - Video(S2110-20)IP Output/IP Output Monitoring

For PGM 1 to 3 and Prvw 1 to 3 (refer to 4.6.1 for details)

IP Output Present: This field indicates if IP output is present or not. It will show up as Inactive or Active.

TS Bits rate: This field shows the video output bitrate in Mbps.

IP Bits Rate: This field shows the IP output bitrate in Mbps.

Clear Stats: This button allows the user to clear all stats.

4.7. VIDEO(S2110-20) IP INPUT

4.7.1. Global Control



Figure 4-31: WebEASY® - Video(S2110-20)IP Input/Global Control

Next Timeout: This field allows the user to set the next IP input timeout value.

4.7.2. IP Input Control

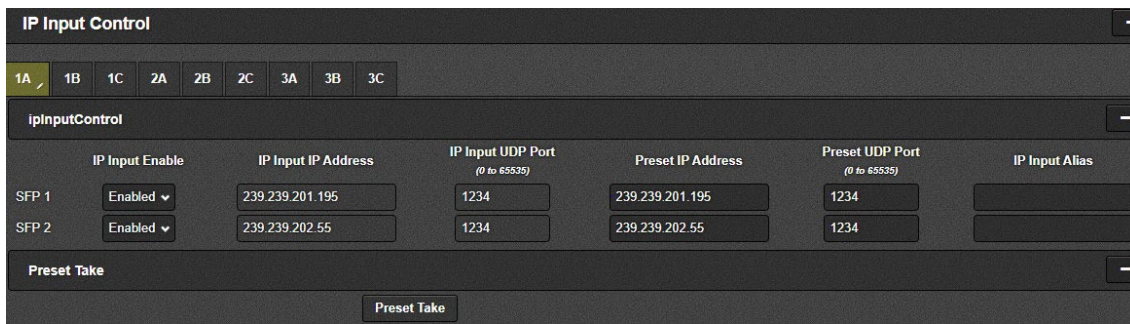

Figure 4-32: WebEASY® - Video(S2110-20)IP Input/IP Input Control

For 1A to 3C (refer to 4.5.1 for details)

IP Input Status: This field shows the IP input status as Enabled or Disabled based on the routing set for the card.

IP Input IP Address: This field shows the IP input IP address.

IP Input UDP Port: This field allows the user or control system to assign the corresponding UDP port.

Preset IP Address: This field allows the user or control system to assign the input IP address.

IP Input Alias: This field allows the user to enter an IP input alias.

Preset Take: This button allows to take the preset IP Address.

4.7.3. IP Input Monitoring

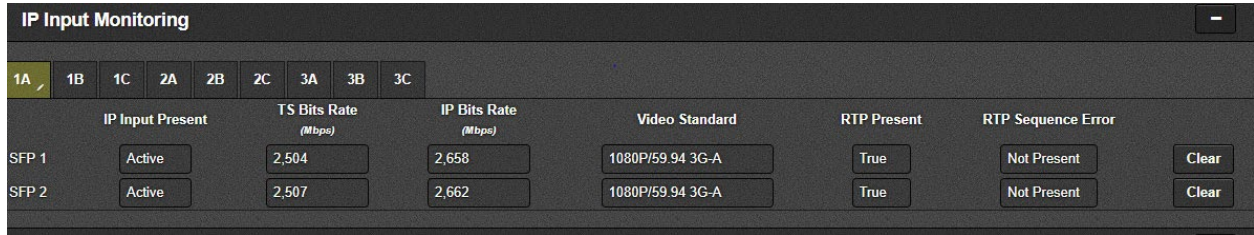

Figure 4-33: WebEASY® - Video(S2110-20)IP Input/IP Input Monitoring

For 1A to 3C (refer to 4.5.1 for details)

IP Output Present: This field indicates if IP Input is present or not. It will show up as Inactive or Active.

TS Bits rate: This field shows the video Input bitrate in Mbps.

IP Bits Rate: This field shows the IP Input bitrate in Mbps.

Video Standard: This field show video standard of IP Input.

RTP Present: This field shows that RTP is present or not for IP Input.

RTP Sequence Error: This field that there are RTP sequence Errors present or not.

Clear: This button allows the user to clear/reset all the monitoring statistics

4.7.4. IP Input IGMP Control



Figure 8-4: WebEASY® - Video(S2110-20)IP Input/IP Input IGMP Control

For 1A to 3C (refer to 4.5.1 for details)

IGMP V3 Mode: This control allows the user to set the IGMP V3 mode to Include or Exclude.

IGMP V3 SSM Src 1-6 IP Address: This field allows the user to set the IGMP V3 SSM source 1-6 IP address.

4.8. AUDIO (S2110-30) IP OUTPUT

Audio (S2110-30) IP Output			
Audio Group 1			
PGM1	PGM2	PGM3	Prvw1 Prvw2 Prvw3
	IP Output Status	Destination IP Address	Destination UDP Port Number <small>(0 to 65535)</small>
SFP 1	Enabled	239.239.209.183	1234
SFP 2	Enabled	239.239.209.219	1234
Audio Group 2			
PGM1	PGM2	PGM3	Prvw1 Prvw2 Prvw3
	IP Output Status	Destination IP Address	Destination UDP Port Number <small>(0 to 65535)</small>
SFP 1	Enabled	239.239.209.184	1234
SFP 2	Enabled	239.239.209.220	1234
Audio Group 3			
PGM1	PGM2	PGM3	Prvw1 Prvw2 Prvw3
	IP Output Status	Destination IP Address	Destination UDP Port Number <small>(0 to 65535)</small>
SFP 1	Enabled	239.239.209.185	1234
SFP 2	Enabled	239.239.209.221	1234
Audio Group 4			
PGM1	PGM2	PGM3	Prvw1 Prvw2 Prvw3
	IP Output Status	Destination IP Address	Destination UDP Port Number <small>(0 to 65535)</small>
SFP 1	Enabled	239.239.209.186	1234
SFP 2	Enabled	239.239.209.222	1234

Figure 4-34: WebEASY® - Audio(S2110-30)IP Output Tab

For PGM 1 to 3 and Prvw 1 to 3 (refer to 4.6.1 for details)

IP Output Status: This parameter shows the status of the IP output.

Destination IP Address: This parameter allows the user or control system to assign an output IP address/multicast address.

Destination UDP Port Number: This parameter allows the user or control system to assign the output UDP port number.

4.9. AUDIO (S2110-30) IP INPUT

Audio (S2110-30) IP Input

Audio Stream 1

	1A	1B	1C	2A	2B	2C	3A	3B	3C
	IP Input Enable			IP Input IP Address			IP Input UDP Port <small>(0 to 65535)</small>		IP Input Present
SFP 1	<input type="button" value="Enabled"/>			<input type="text" value="239.239.201.98"/>			<input type="text" value="1234"/>		<input type="button" value="Yes"/>
SFP 2	<input type="button" value="Enabled"/>			<input type="text" value="239.239.201.221"/>			<input type="text" value="1234"/>		<input type="button" value="Yes"/>

Audio Stream 2

	1A	1B	1C	2A	2B	2C	3A	3B	3C
	IP Input Enable			IP Input IP Address			IP Input UDP Port <small>(0 to 65535)</small>		IP Input Present
SFP 1	<input type="button" value="Enabled"/>			<input type="text" value="239.239.201.99"/>			<input type="text" value="1234"/>		<input type="button" value="Yes"/>
SFP 2	<input type="button" value="Enabled"/>			<input type="text" value="239.239.201.222"/>			<input type="text" value="1234"/>		<input type="button" value="Yes"/>

Audio Stream 3

	1A	1B	1C	2A	2B	2C	3A	3B	3C
	IP Input Enable			IP Input IP Address			IP Input UDP Port <small>(0 to 65535)</small>		IP Input Present
SFP 1	<input type="button" value="Enabled"/>			<input type="text" value="239.239.201.100"/>			<input type="text" value="1234"/>		<input type="button" value="Yes"/>
SFP 2	<input type="button" value="Enabled"/>			<input type="text" value="239.239.201.223"/>			<input type="text" value="1234"/>		<input type="button" value="Yes"/>

Audio Stream 4

	1A	1B	1C	2A	2B	2C	3A	3B	3C
	IP Input Enable			IP Input IP Address			IP Input UDP Port <small>(0 to 65535)</small>		IP Input Present
SFP 1	<input type="button" value="Enabled"/>			<input type="text" value="239.239.201.101"/>			<input type="text" value="1234"/>		<input type="button" value="Yes"/>
SFP 2	<input type="button" value="Enabled"/>			<input type="text" value="239.239.201.224"/>			<input type="text" value="1234"/>		<input type="button" value="Yes"/>

Figure 4-35: WebEASY® - Audio(S2110-30)IP Input Tab

For 1A to 3C (refer to 4.5.1 for details)

IP Input Enable: This field displays the IP input status as Enabled or Disabled based on the routing set for the card.

IP Input IP Address: This field allows the user or control system to assign the IP input IP address.

IP Input UDP Port: This field allows the user or control system to assign the IP input UDP port.

IP Input Present: This field indicates if the IP input is present or not.

4.10. ANC (S2110-40) IP OUTPUT

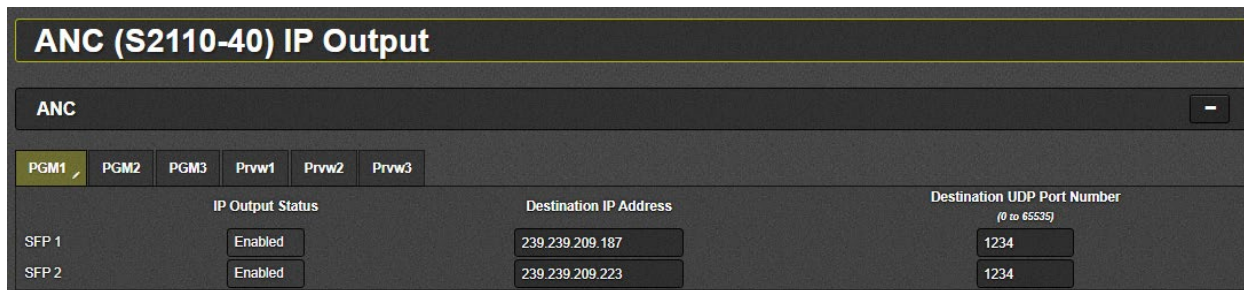

Figure 4-36: WebEASY® - ANC(S2110-40)IP Output Tab

IP Output Status: This parameter shows the IP output status.

Destination IP Address: This field allows the user or control system to assign the output IP address/multicast address.

Destination UDP Port number: This field allows the user or control system to assign the output UDP port number.

4.11. ANC (S2110-40) IP INPUT



Figure 4-37: WebEASY® - ANC(S2110-40)IP Input Tab

For 1A to 3C (refer to 4.5.1 for details)

IP Input Status: This field shows the IP input status as Enabled or Disabled based on the routing set for the card.

IP input IP Address: This field allows the user or control system to assign the IP input IP address.

IP Input UDP Port: This field allows the user or control system to assign the IP input UDP port.

IP Input Present: This field shows if the ANC IP input is present or not.

4.12. PTP CONTROL

4.12.1. PTP Control

PTP Control		
Main / Backup		
SFP Port	SFP 1	
Domain Number	50	(0 to 128)
Priority 1	255	(0 to 255)
Priority 2	255	(0 to 255)

Figure 4-38: WebEASY® - PTP Control/PTP Control

For Main & Backup Ports

SFP Port: This dropdown menu allows the user to select which SFP port to use for a main & a backup PTP source.

Domain Number: This field allows the user to set the PTP domain number which identifies a group of devices that talk together.

Priority 1: This field allows the user to set the priority 1 value for PTP control.

Priority 2: This field allows the user to set the priority 2 value for PTP control.

4.12.2. PTP Monitor

This section allows the user to monitor the current PTP status.

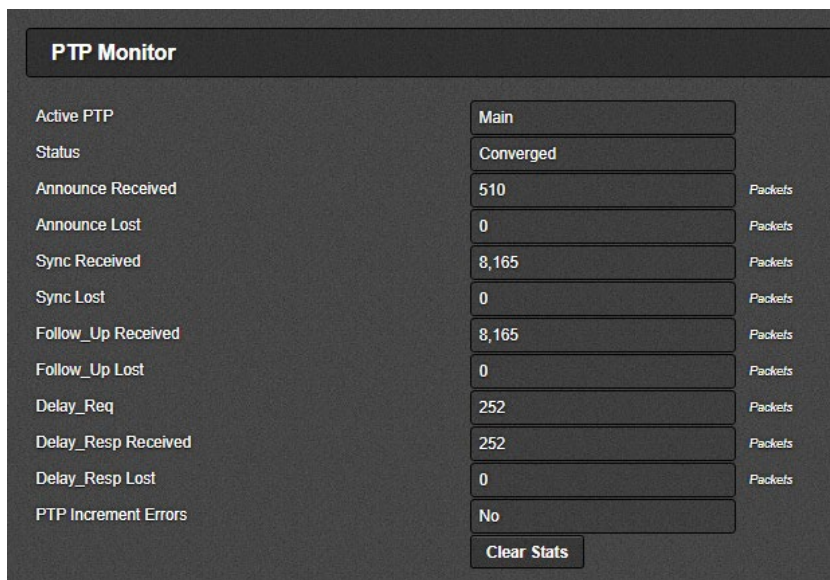

Figure 4-39: WebEASY® - PTP Control/PTP Monitor

Active PTP: This field shows if PTP Main or PTP Backup is currently being used.

Status: This field shows if PTP is currently Absent, Unconverged or Converged. Note that during a PTP failover, this field will show “Absent” & then “unconverged” for some time until PTP gets converged.

Announce Received: Shows the number of PTP announcements have been received.

Announce Lost: Shows if any announcement has been lost. It should be zero.

Sync Received: Shows the number of PTP sync has been received.

Sync Lost: Shows if any sync has been last.

Follow_up Received: Shows the number of follow_up requests received.

Follow_up Lost: Shows if any follow_up request has been lost.

Delay_Req: Shows the number of Delay has been requested.

Delay_Resp Received: Shows the number of Delay has been received. Delay_Req and Delay_Resp Receive have to match, if it doesn't not, then there is a misconfiguration with PTP route.

Delay_Resp Lost: Shows if any Delay response has been lost.

PTP Increment Errors: Shows that there are PTP Increment Errors are present or not.

Clear Stats: This button allows the user to clear the current PTP stats.

4.13. VIDEO NOTIFY

In this tab, users can enable/disable video traps for Video Missing, Video Freeze, Video Packet Error and Video Black for all the streams for all ACO cores.

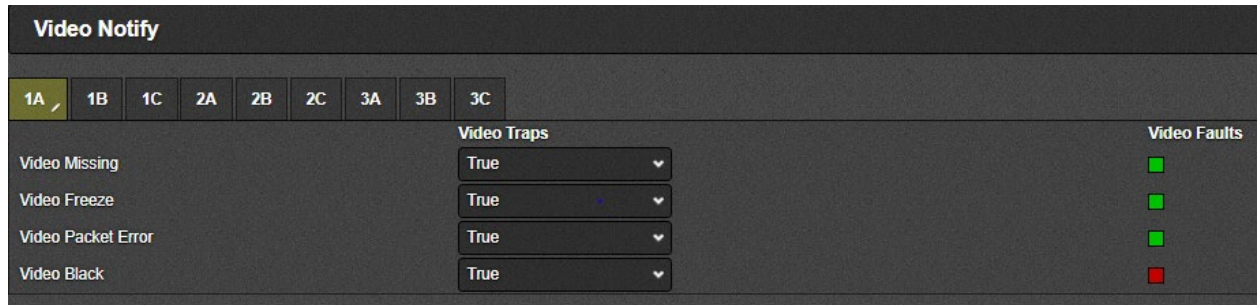

Figure 4-40: WebEASY® - Video Notify Tab

For 1A to 3C (refer to 4.5.1 for details)

Video Traps: This control is used to turn traps On or Off.

Video Faults: This displays whether a fault is currently present or not.

4.14. AUDIO NOTIFY

4.14.1. Audio Monitoring Control

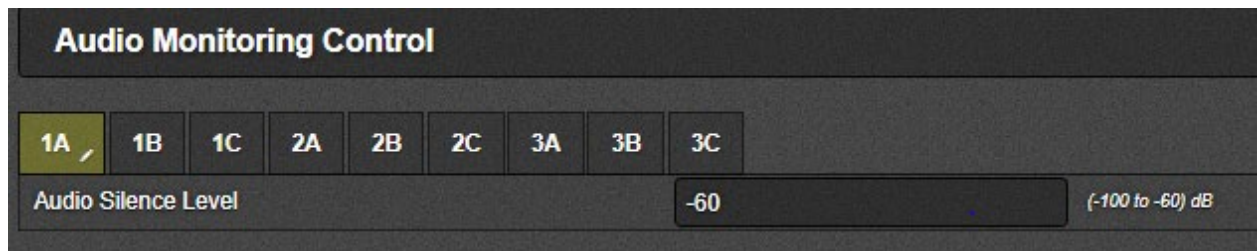

Figure 4-41: WebEASY® - Audio Notify/Audio Monitoring Control

For 1A to 3C (refer to 4.5.1 for details)

Audio Silence Level: In this field user can set silence level for Audio between -100db to -60db.

4.14.2. Audio Failover Notify

In this section, users can Enable/Disable Audio Traps for Audio Missing, Audio Silence and Audio Packet Error by selecting True/False from drop down menu.



Figure 4-42: WebEASY® - Audio Notify/Audio Failover Notify

For 1A to 3C (refer to 4.5.1 for details)

Audio Traps: This control is used to turn traps On or Off.

Audio Faults: This displays whether a fault is currently present or not.

4.14.3. Audio Stream Notify

In this section, users can set the trap for Audio streams1-4 for Audio Missing and Audio Packet Error.

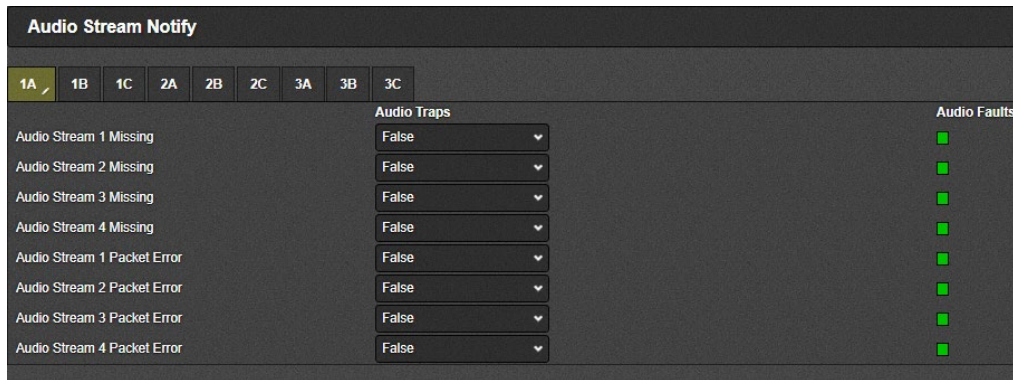

Figure 4-43: WebEASY® - Audio Notify/Audio Stream Notify

For 1A to 3C (refer to 4.5.1 for details)

Audio Traps: This control is used to turn traps On or Off.

Audio Faults: This displays whether a fault is currently present or not.

4.14.4. Audio Channel Notify

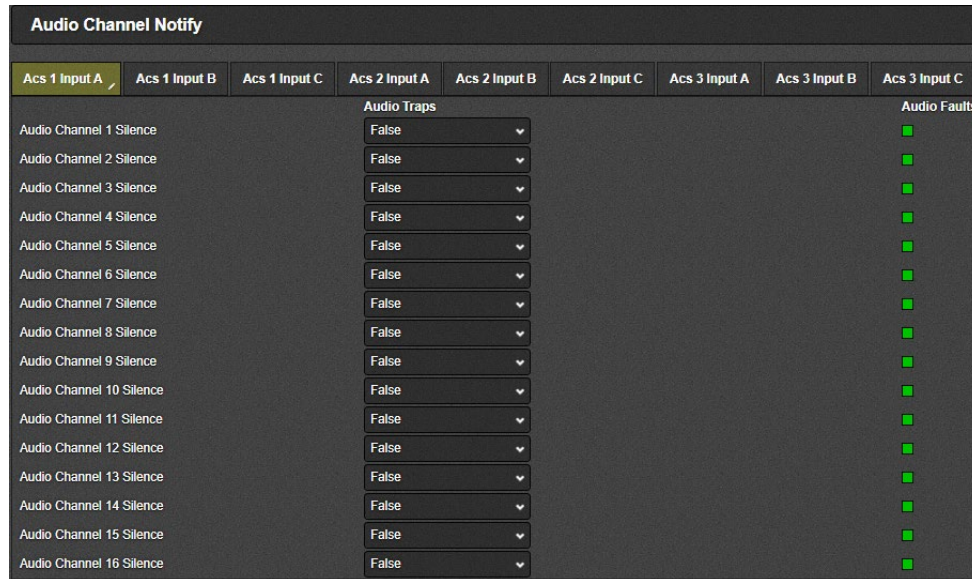

Figure 4-44: WebEASY® - Audio Notify/Audio Channel Notify

For ACS 1 to 3 & Inputs A to 3

Audio Traps: When Enabled, a fault condition will send out a trap message to the trap addresses configured in the Trap Control section of the System tab.

Audio Faults: This monitor will display green when there is no fault on the audio and red for a fault indication.

4.15. ANC NOTIFY

In this tab, user can Enable/Disable the traps for VANC Packet Missing, Close Caption Missing and SCTE104 Missing by selecting True/false from dropdown menu.

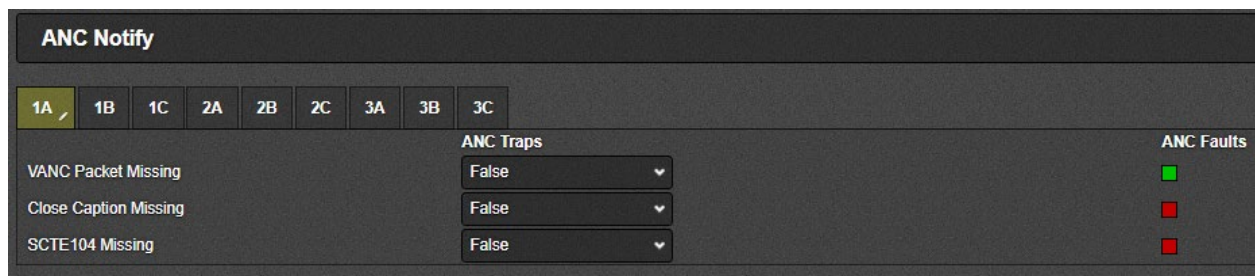

Figure 4-45: WebEASY® - ANC Notify

For 1A to 3C (refer to 4.5.1 for details)

ANC Traps: This control is used to turn traps On or Off.

ANC Faults: This displays whether a fault is currently present or not.

4.16. NOTIFY

4.16.1. Board Notify

In this section users can set the trap Board Fault and Reference Loss

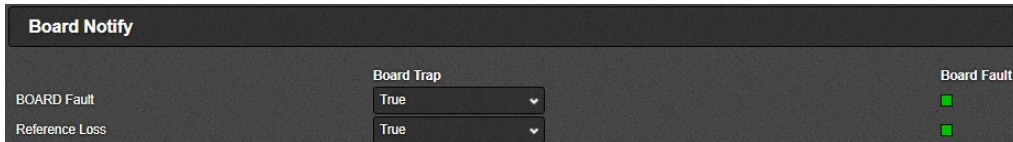

Figure 4-46: WebEASY® - Notify/ Board Notify

Board Trap: This control allows to turn board traps ON or OFF.

Board Fault Present: This indicator displays whether a fault is currently present or not.

4.16.2. Decapsulator Fault

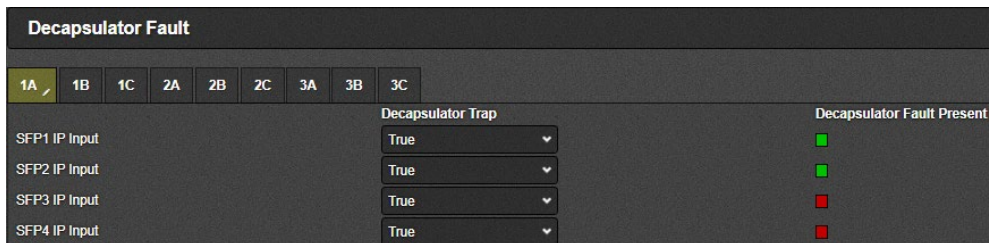

Figure 4-47: WebEASY® - Notify /Decapsulator Fault

For 1A to 3C (refer to 4.5.1 for details)

Decapsulator Trap: This control allows to enable or disable decapsulator traps.

Decapsulator Fault Present: This indicator displays whether a fault is currently present or not.

4.16.3. ACS Fault

In this section, users can set the traps for PGM failover, Preview Failover, Active PGM Output Source Change and Active Preview Output change for all three ACSs.

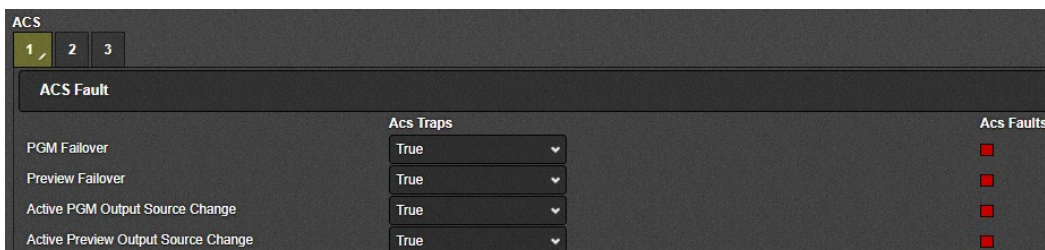

Figure 4-48: WebEASY® - Notify/ ACS Notify /ACS Fault

For ACS 1 to 3

ACS Traps: This control allows the user to enable/disable ACS traps.

ACS Faults: This indicator displays whether an ACS fault is currently present or not.

4.16.4. Clear Faults



Figure 4-49: WebEASY® - Notify/ ACS Notify/ Clear Faults

Clear Faults: By clicking on Clear Faults button user can clear all the ACS Faults.

4.17. SNMP TRAP

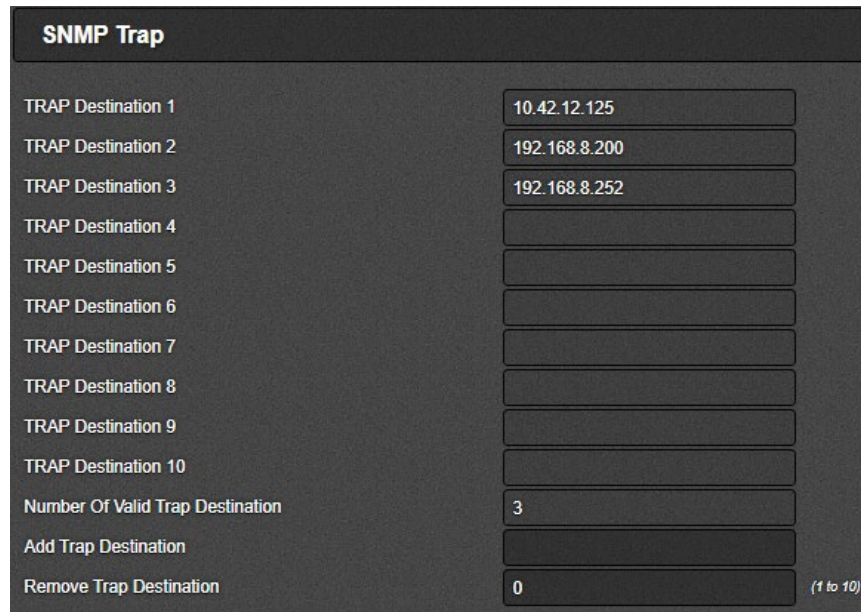

Figure 4-50: WebEASY® - SNMP Trap/SNMP Trap

TRAP Destination 1-10: This parameter allows the user to view current trap destinations & to set more trap destinations.

Number of Valid Trap Destination: This parameter shows the current number of valid trap destinations present.

Add Trap Destination: This parameter allows the user to add an IP to the trap destination list. Make sure you click the “Apply” button for changes to take effect

Remove Trap Destination: This parameter allows the user to remove a trap destination from the list. Make sure you click the “Apply” button for changes to take effect

This page left intentionally blank

5. FIRMWARE UPGRADE

Using the WebEASY® on a web interface is the fastest and recommended procedure to load the firmware onto the 570ACO-X19-10G.

5.1. FIRMWARE UPGRADE USING WEBEASY®

When first visiting the 570ACO-X19-10G web interface, the user will be asked to enter a Login and Password. Enter “**customer**” for Login and “**customer**” for Password.

On the top of the web page for the 570ACO-X19-10G, there is a tab labeled **Upgrade**. The **Upgrade** tab is used to check current firmware version and upload the latest firmware.

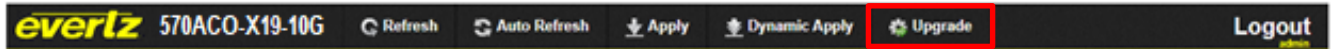

Figure 5-1: WebEASY® - Upgrade Button on Top Menu Bar

Selecting the *Upgrade* tab, will open a new window as shown in Figure 5-2 where the current firmware version is shown. Should the firmware version be outdated, the user will need to download the firmware image file.



NOTE: Contact Evertz to get the latest firmware file.

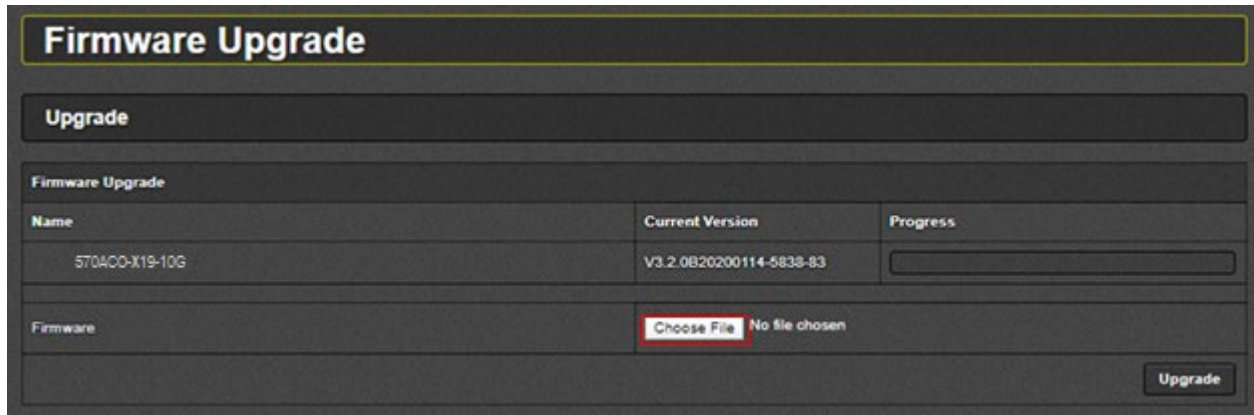

Figure 5-2: WebEASY® - Firmware Upgrade Menu

Click **Choose File** and browse to locate image file.

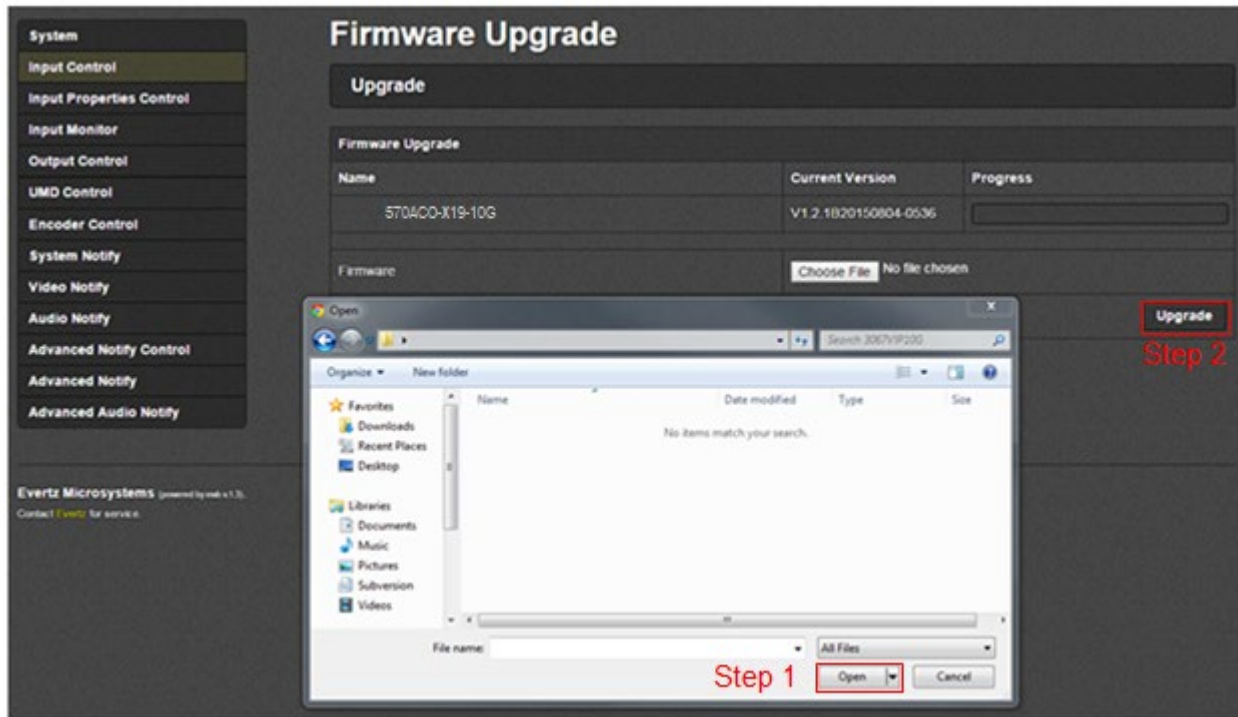

Figure 5-3: WebEASY® - Firmware Upgrade Menu

Once selected, click **Open** (Step 1) to advance to next step. Click **Upgrade** (Step 2) and watch progress bar for status. Once completed, the device will automatically restart.

5.2. FIRMWARE UPGRADE THROUGH VISTALINK PRO

To ensure that the 7708VB-4-1H-SE is running the latest firmware, follow the below steps:

1. Right click on the 570ACO under the Hardware menu → Click on Version Information.
2. In version information window Select 570ACO-X19-10G under hardware.

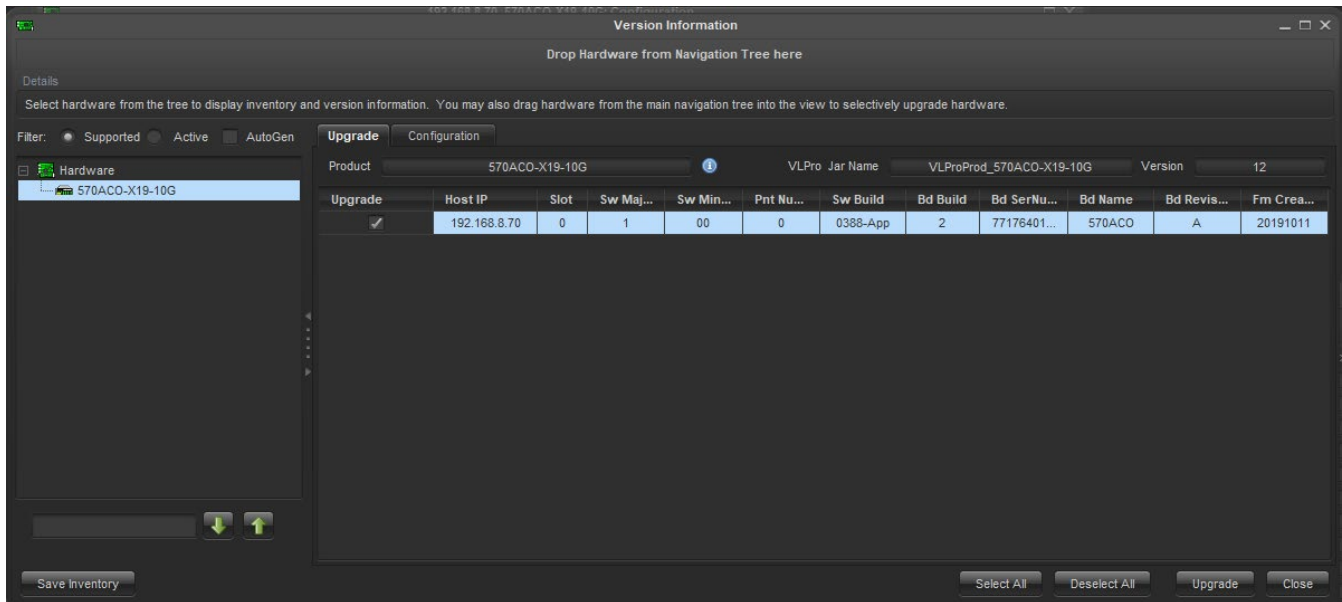

Figure 5-4: VistaLINK Pro/Version Information

3. User can check current jar version and current firmware version loaded on 570ACO.
4. To upgrade firmware first check the checkbox for 570ACO under Upgrade column
5. Then click on Upgrade and browse to locate image file.
6. Once selected, click on OK to advance to next step.
7. Click start and watch Status and Progress.

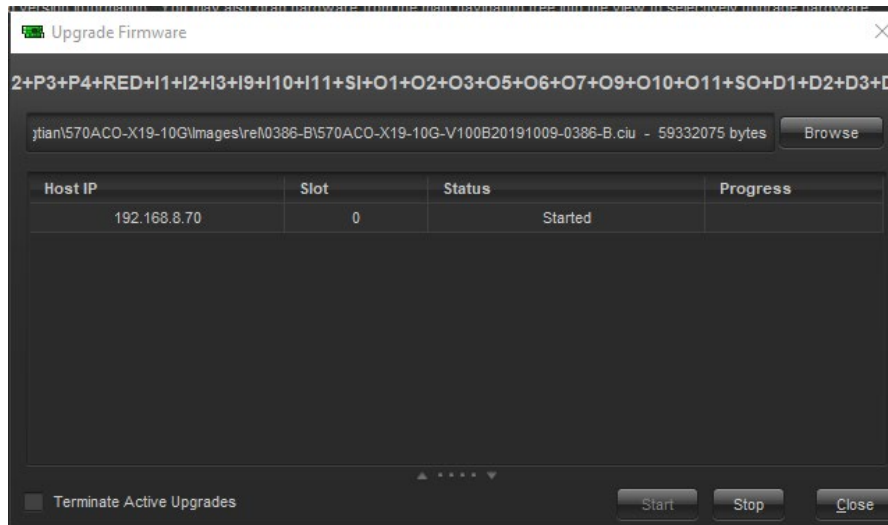

Figure 5-5: VistaLINK Pro/Upgrade Firmware

- Then after some time you will see Upgrade logon window with default username(customer) and password(customer). Click on Ok.

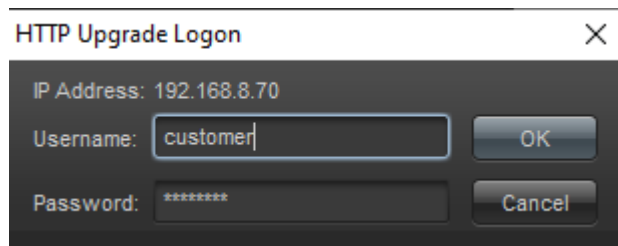

Figure 5-6: VistaLINK Pro/Upgrade Logon

- Once completed, the device will automatically reboot and you'll see following window in VistaLINK Pro:

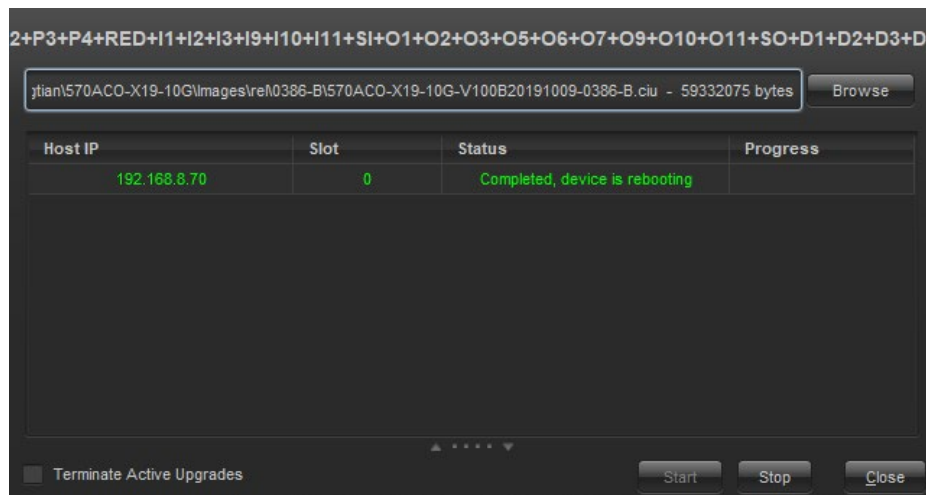

Figure 5-7: VistaLINK Pro/ Upgrade completed