

**Model HD9690 Series
High Definition Graticule Generator
Instruction Manual**

© Copyright 2005 - 2011

EVERTZ MICROSYSTEMS LTD.

5292 John Lucas Drive,
Burlington, Ontario,
Canada,
L7L 5Z9



Phone:	905-335-3700
Sales Fax:	905-335-3573
Service Fax:	905-335-7571
Internet:	Sales: sales@evertz.com
	Tech Support: service@evertz.com
	Web Page: http://www.evertz.com

Version 1.5 April 2011

The material contained in this manual consists of information that is the property of Evertz Microsystems and is intended solely for the use of purchasers of the Profanity Bypass Delay System. Evertz Microsystems expressly prohibits the use of this manual for any purpose other than the operation of these units.

All rights reserved. No part of this publication may be reproduced without the express written permission of Evertz Microsystems Ltd. Copies of this guide can be ordered from your Evertz products dealer or from Evertz Microsystems.

IMPORTANT SAFETY INSTRUCTIONS

	The lightning flash with arrowhead symbol within an equilateral triangle is intended to alert the user to the presence of uninsulated “Dangerous voltage” within the product’s enclosure that may be of sufficient magnitude to constitute a risk of electric shock to persons.
	The exclamation point within an equilateral triangle is intended to alert the user to the presence of important operating and maintenance (Servicing) instructions in the literature accompanying the product.

- Read this information
- Keep these instructions.
- Heed all warnings.
- Follow all instructions.
- Do not use this apparatus near water
- Clean only with dry cloth.
- Do not block any ventilation openings. Install in accordance with the manufacturer’s instructions.
- Do not install near any heat sources such as radiators, heat registers, stoves, or other apparatus (including amplifiers) that produce heat.
- Do not defeat the safety purpose of the polarized or grounding type plug. A polarized plug has two blades with one wider than other. A grounding type plug has two blades and a third grounding prong. The wide blade or the third prong are provided for your safety. If the provided plug does not fit into your outlet, consult an electrician for replacement of the obsolete outlet.
- Protect the power cord from being walked on or pinched particularly at plugs, convenience receptacles and the point where they exit from the apparatus.
- Only use attachments/accessories specified by the manufacturer
- Unplug this apparatus during lightning storms or when unused for long periods of time.
- Refer all servicing to qualified service personnel. Servicing is required when the apparatus has been damaged in any way, such as power-supply cord or plug is damaged, liquid has been spilled or objects have fallen into the apparatus, the apparatus has been exposed to rain or moisture, does not operate normally, or has been dropped.

WARNING

TO REDUCE THE RISK OF FIRE OR ELECTRIC – SHOCK, DO NOT EXPOSE THIS APPARATUS TO RAIN OR MOSITURE”

WARNING

DO NOT EXPOSE THIS EQUIPMENT TO DRIPPING OR SPLASHING AND ENSURE THAT NO OBJECTS FILLED WITH LIQUIDS, SUCH AS VASES, ARE PLACED ON THE EQUIPMENT”

WARNING

TO COMPLETELY DISCONNECT THIS EQUIPMENT FROM THE AC MAINS, DISCONNECT THE POWER SUPPLY CORD PLUG FROM THE AC RECEPTACLE”

WARNING

THE MAINS PLUG OF THE POWER SUPPLY CORD SHALL REMAIN READILY OPERALBLE”

INFORMATION TO USERS IN EUROPE

NOTE

This equipment with the CE marking complies with both the EMC Directive (2004/108/EC) and the Low Voltage Directive (2006/95/EC) issued by the Commission of the European Community.

Compliance with these directives implies conformity to the following European standards:

- EN60065 Product Safety
- EN55103-1 Electromagnetic Interference Class A (Emission)
- EN55103-2 Electromagnetic Susceptibility (Immunity)

This equipment has been tested and found to comply with the limits for a Class A digital device, pursuant to the European Union EMC directive. These limits are designed to provide reasonable protection against harmful interference when the equipment is operated in a commercial environment. This equipment generates, uses, and can radiate radio frequency energy and, if not installed and used in accordance with the instruction manual, may cause harmful interference to radio communications. Operation of this equipment in a residential area is likely to cause harmful interference in which case the user will be required to correct the interference at his own expense.

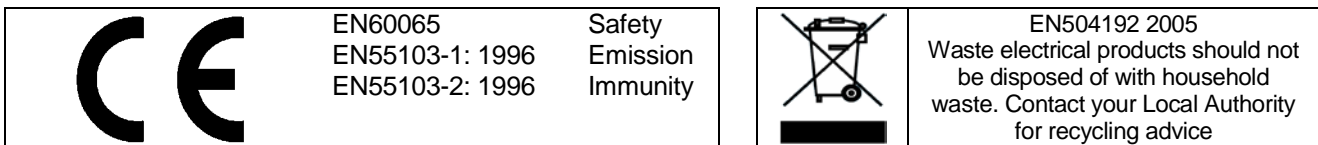

INFORMATION TO USERS IN THE U.S.A.

NOTE

FCC CLASS A DIGITAL DEVICE OR PERIPHERAL

This equipment has been tested and found to comply with the limits for a Class A digital device, pursuant to Part 15 of the FCC Rules. These limits are designed to provide reasonable protection against harmful interference when the equipment is operated in a commercial environment. This equipment generates, uses, and can radiate radio frequency energy and, if not installed and used in accordance with the instruction manual, may cause harmful interference to radio communications. Operation of this equipment in a residential area is likely to cause harmful interference in which case the user will be required to correct the interference at his own expense.

WARNING

Changes or modifications not expressly approved by Evertz Microsystems Ltd. could void the user's authority to operate the equipment. Use of unshielded plugs or cables may cause radiation interference. Properly shielded interface cables with the shield connected to the chassis ground of the device must be

Evertz Microsystems Ltd		Tested to comply with FCC Standards	This device complies with part 15 of the FCC Rules. Operation is subject to the following two conditions:
For Commercial Use			This device may cause harmful interference, and this device must accept any interference received, including interference that may cause undesired operation.

REVISION HISTORY

<u>REVISION</u>	<u>DESCRIPTION</u>	<u>DATE</u>
0.1	Preliminary Manual	Aug 2005
0.2	Updated to features of first release firmware	Oct 2005
1.0	First release - Added support for HD9690 (422 only Graticule generator) Added support for 720p/50	Oct 2005
1.1	Added support for 4:4:4 RGB with Full scale values Added support for manual 4:4:4 and 4:2:2 modes on HD9690-444	Jan 2006
1.2	Updated with support for DCP Desktop Remote Panel operation Fixed typos in Factory Presets. Support for Firmware version 1.01 build 1	Feb 2006
1.2.1	Added Ethernet specification Added descriptions of object position, and drawing describing the mask	Mar 2006
1.2.2	Fixed typos in FTP upload section for config loading.	Apr 2006
1.3	Added Dashed line boxes, support for 2048x1080 24sF Digital cinema video Added Opacity Control from Mask	Jul 2007
1.4	Added support for SMPTE ST 2046 Safe areas in Factory Presets	Feb 2010
1.5	Added support for SMPTE ST 292-2 Stereoscopic Video with +3D Option	Apr 2011

Information contained in this manual is believed to be accurate and reliable. However, Evertz assumes no responsibility for the use thereof or for the rights of third parties, which may be effected in any way by the use thereof. Any representations in this document concerning performance of Evertz products are for informational use only and are not warranties of future performance, either expressed or implied. The only warranty offered by Evertz in relation to this product is the Evertz standard limited warranty, stated in the sales contract or order confirmation form.

Although every attempt has been made to accurately describe the features, installation and operation of this product in this manual, no warranty is granted nor liability assumed in relation to any errors or omissions unless specifically undertaken in the Evertz sales contract or order confirmation. Information contained in this manual is periodically updated and changes will be incorporated into subsequent editions. If you encounter an error, please notify Evertz Customer Service department. Evertz reserves the right, without notice or liability, to make changes in equipment design or specifications.

This page left intentionally blank

TABLE OF CONTENTS

1. OVERVIEW	1-1
1.1. HOW TO USE THIS MANUAL	1-3
1.2. GLOSSARY.....	1-4
1.2.1. Graticule Generator Terminology/Definitions	1-7
2. INSTALLATION.....	2-1
2.1. REAR PANEL OVERVIEW	2-1
2.1.1. HD Video Connections (HD9690)	2-1
2.1.2. HD Video Connections (HD9690-444)	2-1
2.1.3. DVI Video Connections	2-2
2.1.4. Serial I/O and GPI/O Connections	2-2
2.1.5. Ethernet Network Connections	2-3
2.2. MOUNTING	2-3
2.3. POWER REQUIREMENTS.....	2-3
2.4. CONNECTING THE VIDEO.....	2-4
2.4.1. Video Inputs	2-4
2.4.2. Video Outputs.....	2-4
2.5. CONNECTING TO AN ETHERNET NETWORK.....	2-5
2.6. CONNECTING THE GENERAL PURPOSE INPUTS	2-6
2.7. CONNECTING THE REMOTE CONTROL PANEL (RCP AND DCP VERSIONS ONLY)	2-6
3. HOW TO OPERATE THE GRATICULE GENERATOR USING THE RACK MOUNT CONTROL PANEL	3-1
3.1. AN OVERVIEW OF THE KEY AND DISPLAY FUNCTIONS.....	3-1
3.1.1. The Object Pushbutton Group	3-2
3.1.2. The Setup Button Group.....	3-2
3.1.3. The Preset Button Group.....	3-3
3.1.4. Shaft Encoders (Knobs)	3-3
3.1.5. Status Indicators.....	3-4
3.1.6. Front Panel Display Messages	3-4
3.2. SETUP MENU	3-5
3.2.1. Choosing the Raster limits for the Mask Aspect Ratio and Size Calculation	3-6
3.2.2. Choosing the Raster limits for the Box Size Calculation	3-6
3.2.3. Choosing the Object Blink Time	3-6
3.2.4. Choosing How Line Numbers are Displayed	3-7
3.2.5. Displaying Object Aspect Ratio or Position on the Front Panel.....	3-7
3.2.6. Forcing all Objects to be Centred on the Raster	3-7
3.2.7. Setting how long the On Screen Display will be Active	3-8
3.2.8. Selecting the On Screen Display Position.....	3-8
3.2.9. Selecting the SMPTE Safe Area Specification.....	3-8
3.2.10. Operating the HD9690 in Auto Video Standard Mode.....	3-8
3.2.11. Selecting the Video Type (Model HD9690-444 only)	3-9
3.2.12. Selecting the 4:4:4 Colour Space (Model HD9690-444 only)	3-9
3.3. CONTROLLING THE INDIVIDUAL OBJECTS.....	3-11
3.3.1. Controlling the Object Modes	3-11

3.3.1.1.	Display Mode	3-12
3.3.1.2.	Centre Mode	3-12
3.3.2.	Aspect Ratio Mode	3-12
3.3.3.	Controlling the Object Attributes	3-12
3.3.4.	Front Panel Display when Controlling the Objects	3-13
3.3.5.	On Screen Display when Controlling the Objects	3-13
3.4.	CONTROLLING THE GRID OBJECT	3-13
3.4.1.	Turning the <i>Grid</i> Object On and Off	3-13
3.4.2.	Controlling the <i>Grid</i> Modes	3-14
3.4.2.1.	Centering the <i>Grid</i> on the Raster	3-14
3.4.3.	Controlling the <i>Grid</i> Attributes	3-14
3.4.3.1.	Controlling the <i>Grid</i> Colour	3-14
3.4.3.2.	Controlling the <i>Grid</i> Line Width	3-14
3.4.3.3.	Controlling the <i>Grid</i> Size (<i>Grid</i> Centred)	3-15
3.4.3.4.	Controlling the <i>Grid</i> Size and Position (<i>Grid</i> not centred)	3-15
3.5.	CONTROLLING THE MASK OBJECT	3-15
3.5.1.	Turning the Mask Object On and Off	3-16
3.5.2.	Controlling the <i>Mask</i> Modes	3-16
3.5.2.1.	Controlling the Aspect Ratio of the <i>Mask</i>	3-16
3.5.2.2.	Centering the Mask on the Raster	3-16
3.5.2.3.	Controlling the Opacity (Transparency) of the <i>Mask</i>	3-17
3.5.3.	Controlling the <i>Mask</i> Attributes	3-17
3.5.3.1.	Controlling the <i>Mask</i> Colour	3-17
3.5.3.2.	Controlling the <i>Mask</i> Size (<i>Mask</i> Centred, Aspect Ratio Off)	3-17
3.5.3.3.	Controlling the <i>Mask</i> Size (<i>Mask</i> Centred, Aspect Ratio On)	3-18
3.5.3.4.	Controlling the <i>Mask</i> Size and Position (<i>Mask</i> not centred, Aspect Ratio Off)	3-18
3.5.3.5.	Controlling the <i>Mask</i> Size and Position (<i>Mask</i> not centred, Aspect Ratio On)	3-18
3.6.	CONTROLLING THE CURSOR OBJECTS	3-19
3.6.1.	Turning the <i>Cursor</i> Objects On and Off	3-19
3.6.2.	Controlling the <i>Cursor</i> Modes	3-19
3.6.2.1.	Centering the Cursor on the Raster	3-19
3.6.3.	Controlling the <i>Cursor</i> Attributes	3-20
3.6.3.1.	Controlling the <i>Cursor</i> Colour	3-20
3.6.3.2.	Controlling the <i>Cursor</i> Line Width	3-20
3.6.3.3.	Controlling the <i>Cursor</i> Size	3-20
3.6.3.4.	Controlling the <i>Cursor</i> Position (<i>Cursor</i> not centred)	3-20
3.7.	CONTROLLING THE BOX OBJECTS	3-20
3.7.1.	Turning the Box Objects On and Off	3-21
3.7.2.	Controlling the <i>Box</i> Modes	3-21
3.7.2.1.	Controlling the Aspect Ratio of the <i>Box</i>	3-21
3.7.2.2.	Choosing a Solid or Dashed Box	3-21
3.7.2.3.	Centering the Box on the Raster	3-21
3.7.3.	Controlling the <i>Box</i> Attributes	3-22
3.7.3.1.	Controlling the <i>Box</i> Colour	3-22
3.7.3.2.	Controlling the <i>Box</i> Line Width	3-22
3.7.3.3.	Controlling the <i>Box</i> Size (<i>Box</i> Centred, Aspect Ratio Off)	3-22
3.7.3.4.	Controlling the <i>Box</i> Size and Position (<i>Box</i> centred, Aspect Ratio On)	3-23
3.7.3.5.	Controlling the <i>Box</i> Size and Position (<i>Box</i> not centred, Aspect Ratio Off)	3-23
3.7.3.6.	Controlling the <i>Box</i> Size and Position (<i>Box</i> not centred, Aspect Ratio On)	3-23
3.8.	CONTROLLING THE ELLIPSE OBJECT	3-24
3.8.1.	Turning the <i>Ellipse</i> Object On and Off	3-24

3.8.2.	Controlling the <i>Ellipse</i> Modes	3-24
3.8.2.1.	Controlling the Aspect Ratio of the <i>Ellipse</i>	3-24
3.8.2.2.	Centering the <i>Ellipse</i> on the Raster.....	3-24
3.8.3.	Controlling the <i>Ellipse</i> Attributes.....	3-25
3.8.3.1.	Controlling the <i>Ellipse</i> Colour	3-25
3.8.3.2.	Controlling the <i>Ellipse</i> Line Width.....	3-25
3.8.3.3.	Controlling the <i>Ellipse</i> Size (<i>Ellipse</i> Centred, Aspect Ratio Off).....	3-25
3.8.3.4.	Controlling the <i>Ellipse</i> Size and Position (<i>Ellipse</i> centred, Aspect Ratio On)	3-25
3.8.3.5.	Controlling the <i>Ellipse</i> Size and Position (<i>Ellipse</i> not centred, Aspect Ratio Off) .	3-26
3.8.3.6.	Controlling the <i>Ellipse</i> Size and Position (<i>Ellipse</i> not centred, Aspect Ratio On) .	3-26
3.9.	LOADING FACTORY PRESETS.....	3-26
3.10.	WORKING WITH THE USER PRESETS.....	3-26
3.10.1.	Saving User Presets.....	3-27
3.10.2.	Recalling User Presets.....	3-27
3.10.3.	Customizing the User Preset Names.....	3-27
4.	HOW TO OPERATE THE GRATICULE GENERATOR USING THE DESKTOP REMOTE CONTROL PANEL	4-1
4.1.	AN OVERVIEW OF THE KEY AND DISPLAY FUNCTIONS.....	4-1
4.1.1.	The Object Push-button Group.....	4-2
4.1.2.	The Setup Button Group.....	4-2
4.1.3.	The Preset Group.....	4-3
4.1.4.	Shaft Encoders (Knobs)	4-3
4.1.5.	Status Indicators.....	4-4
4.1.6.	Front Panel Display Messages.....	4-4
4.2.	SETUP MENU	4-4
4.2.1.	Choosing the Raster limits for the Mask Aspect Ratio and Size Calculation	4-5
4.2.2.	Choosing the Raster limits for the Box Size Calculation	4-6
4.2.3.	Choosing the Object Blink Time	4-6
4.2.4.	Choosing How Line Numbers are Displayed	4-6
4.2.5.	Displaying Object Aspect Ratio or Position on the Front Panel.....	4-7
4.2.6.	Forcing all Objects to be Centered on the Raster	4-7
4.2.7.	Setting how long the On Screen Display will be Active	4-7
4.2.8.	Selecting the On Screen Display Position.....	4-8
4.2.9.	Selecting the SMPTE Safe Area Specification.....	4-8
4.2.10.	Operating the HD9690 in Auto Video Standard Mode.....	4-8
4.2.11.	Selecting the Video Type (Model HD9690-444 only)	4-8
4.2.12.	Selecting the 4:4:4 Colour Space (Model HD9690-444 only)	4-9
4.3.	CONTROLLING THE INDIVIDUAL OBJECTS.....	4-10
4.3.1.	Controlling the Object Aspect Ratios	4-10
4.3.2.	Controlling the Object Size	4-11
4.3.3.	Controlling the Object Position	4-11
4.3.4.	Controlling the Object Colour.....	4-12
4.3.5.	Remote Panel Display when Controlling the Objects.....	4-12
4.3.6.	On Screen Display when Controlling the Objects	4-12
4.4.	CONTROLLING THE GRID OBJECT	4-13
4.4.1.	Turning the <i>Grid</i> Object On and Off	4-13
4.4.2.	Centering the <i>Grid</i> on the Raster.....	4-13
4.4.2.1.	Controlling the <i>Grid</i> Colour.....	4-13
4.4.3.	Controlling the <i>Grid</i> Size.....	4-13
4.4.3.1.	Controlling the <i>Grid</i> Size (<i>Objects</i> centred or Aspect Ratio mode On).....	4-13

4.4.3.2. Controlling the <i>Grid</i> Size and Position (<i>Objects</i> not centred, Aspect Ratio Off) ...	4-14
4.5. CONTROLLING THE MASK OBJECT	4-14
4.5.1. Turning the Mask Object On and Off	4-15
4.5.2. Controlling the Aspect Ratio of the <i>Mask</i>	4-15
4.5.2.1. Centering the <i>Mask</i> on the Raster.....	4-15
4.5.2.2. Controlling the <i>Mask</i> Colour	4-15
4.5.3. Controlling the <i>Mask</i> Size.....	4-15
4.5.3.1. Controlling the <i>Mask</i> Size (<i>Objects</i> centred, Aspect Ratio Off).....	4-16
4.5.3.2. Controlling the <i>Mask</i> Size(Aspect Ratio On)	4-16
4.5.3.3. Controlling the <i>Mask</i> Size and Position (<i>Objects</i> not centred, Aspect Ratio Off)..	4-16
4.5.4. Controlling the <i>Mask</i> Position	4-16
4.6. CONTROLLING THE CURSOR OBJECT	4-16
4.6.1. Turning the <i>Cursor</i> Object On and Off	4-17
4.6.2. Centering the Cursor on the Raster	4-17
4.6.2.1. Controlling the <i>Cursor</i> Colour.....	4-17
4.6.2.2. Controlling the <i>Cursor</i> Size	4-17
4.6.2.3. Controlling the <i>Cursor</i> Position (<i>Objects</i> not centred, Aspect Ratio Off).....	4-17
4.7. CONTROLLING THE BOX OBJECTS	4-17
4.7.1. Turning the Box Objects On and Off.....	4-18
4.7.2. Controlling the Aspect Ratio of the <i>Box</i>	4-18
4.7.3. Centering the Box on the Raster	4-18
4.7.3.1. Controlling the <i>Box</i> Colour	4-18
4.7.4. Controlling the <i>Box</i> Size	4-19
4.7.4.1. Controlling the <i>Box</i> Size (<i>Objects</i> centred, Aspect Ratio Off).....	4-19
4.7.4.2. Controlling the <i>Box</i> Size (Aspect Ratio On).....	4-19
4.7.4.3. Controlling the <i>Box</i> Size and Position (<i>Objects</i> not centred, Aspect Ratio Off)....	4-19
4.7.5. Controlling the <i>Box</i> Position	4-19
4.8. CONTROLLING THE ELLIPSE OBJECT	4-20
4.8.1. Turning the <i>Ellipse</i> Object On and Off	4-20
4.8.2. Controlling the Aspect Ratio of the <i>Ellipse</i>	4-20
4.8.2.1. Centering the <i>Ellipse</i> on the Raster.....	4-20
4.8.2.2. Controlling the <i>Ellipse</i> Colour	4-20
4.8.3. Controlling the <i>Ellipse</i> Size.....	4-20
4.8.3.1. Controlling the <i>Ellipse</i> Size (<i>Objects</i> centred, Aspect Ratio Off).....	4-21
4.8.3.2. Controlling the <i>Ellipse</i> Size (Aspect Ratio On)	4-21
4.8.3.3. Controlling the <i>Ellipse</i> Size and Position (<i>Objects</i> not centred, Aspect Ratio Off)	4-21
4.8.4. Controlling the <i>Ellipse</i> Position	4-21
4.9. LOADING FACTORY PRESETS	4-21
4.10. WORKING WITH THE USER PRESETS	4-22
4.10.1. Saving User Presets.....	4-22
4.10.2. Recalling User Presets	4-22
4.10.3. Customizing the User Preset Names.....	4-22
5. TECHNICAL DESCRIPTION	5-1
5.1. SPECIFICATIONS	5-1
5.1.1. Serial Digital Video Inputs	5-1
5.1.2. Serial Digital Video Outputs.....	5-1
5.1.3. Digital (DVI) Video Output	5-1
5.1.4. GPI Control Port.....	5-1
5.1.5. Upgrade Control Port	5-2

5.1.6. Remote Panel Port	5-2
5.1.7. Ethernet.....	5-2
5.1.8. Electrical.....	5-2
5.1.9. Physical.....	5-3
5.2. SERVICING INSTRUCTIONS.....	5-3
5.2.1. Changing the Fuses	5-3
5.3. UPGRADING FIRMWARE.....	5-3
5.3.1. Upgrading the Firmware Using FTP	5-4
5.3.1.1. Step 1 – Determine the IP Addresses	5-4
5.3.1.2. Step 2 – Establishing a Valid Network Connection.....	5-6
5.3.1.3. Step 3 – Upgrading the Application Code.....	5-6
5.3.1.4. Step 4 – Completing the Upgrade	5-8
5.3.2. Upgrading the Firmware Using RS-232 Serial Cable	5-8
5.3.2.1. Step 1 – Setup.....	5-8
5.3.2.2. Step 2 – Invoke Upload Mode From The Terminal Program.....	5-8
5.3.2.3. Step 3 – Uploading the New Firmware	5-9
5.3.2.4. Step 4 – Completing the Upgrade	5-9
5.4. UPLOADING AND DOWNLOADING THE USER PRESETS TO A COMPUTER	5-10
5.4.1. Downloading Preset Files from the Graticule Generator	5-10
5.4.2. Editing User Preset files	5-11
5.4.3. Uploading Preset Files to the Graticule Generator.....	5-11
5.5. WRITE-PROTECTING THE USER PRESETS.....	5-12
5.6. RESTORING THE GRATICULE GENERATOR TO ITS FACTORY DEFAULTS	5-13
6. VIDEO STANDARD RASTER DEFINITIONS.....	6-1
6.1. HIGH DEFINITION VIDEO FORMAT SUMMARY	6-1
6.1.1. Interlaced and Segmented Frame HD formats: 1080I, 1035I, 1080PsF	6-1
6.1.2. Progressive HD formats: 1080P, 720P	6-2
6.1.3. Digital Cinema HD formats: 2048x1080PsF	6-3
6.2. PRODUCTION AND CLEAN APERTURES	6-3
7. FACTORY PRESETS.....	7-1
7.1. CURRENT SAFE AREAS SPECIFIED IN SMPTE ST 2046-1-2009.....	7-1
7.1.1. ALL OBJECT RESET	7-1
7.1.2. CLEAN APERTURE PRESETS	7-1
7.1.2.1. 16:9 SA/ST CA.....	7-1
7.1.2.2. 4:3 SA/ST CA	7-2
7.1.2.3. 14:9 SA/ST CA.....	7-2
7.1.2.4. 1.66 MASK CA.....	7-2
7.1.2.5. 1.85 MASK CA.....	7-3
7.1.2.6. 2.35 MASK CA.....	7-3
7.1.3. PRODUCTION APERTURE PRESETS.....	7-3
7.1.3.1. 16:9 SA/ST PA.....	7-3
7.1.3.2. 4:3 SA/ST PA.....	7-4
7.1.3.3. 14:9 SA/ST PA.....	7-4
7.1.3.4. 1.66 MASK PA.....	7-4
7.1.3.5. 1.85 MASK PA.....	7-5
7.1.3.6. 2.35 MASK PA.....	7-5
7.2. LEGACY SAFE AREAS SPECIFIED IN SMPTE RP218	7-5

7.2.1.	ALL OBJECT RESET	7-5
7.2.2.	CLEAN APERTURE PRESETS	7-5
7.2.2.1.	16:9 SA/ST CA	7-5
7.2.2.2.	4:3 SA/ST CA	7-6
7.2.2.3.	14:9 SA/ST CA	7-6
7.2.2.4.	1.66 MASK CA.....	7-7
7.2.2.5.	1.85 MASK CA.....	7-7
7.2.2.6.	2.35 MASK CA.....	7-7
7.2.3.	PRODUCTION APERTURE PRESETS	7-8
7.2.3.1.	16:9 SA/ST PA.....	7-8
7.2.3.2.	4:3 SA/ST PA.....	7-8
7.2.3.3.	14:9 SA/ST PA.....	7-8
7.2.3.4.	1.66 MASK PA.....	7-9
7.2.3.5.	1.85 MASK PA.....	7-9
7.2.3.6.	2.35 MASK PA.....	7-9
8.	SAFE AREA OPERATIONAL PRACTICES.....	8-1
8.1.	FREE TV AUSTRALIA OPERATION PRACTICE OP-36.....	8-1
8.1.1.	HDTV – SAFE ACTION AND SAFE GRAPHIC AREAS	8-1
8.2.	720P OPERATIONAL PRACTICE	8-3

Figures

Figure 1-1:	HD9690 Block Diagram.....	1-2
Figure 1-2:	HD9690-444 Block Diagram.....	1-3
Figure 2-1:	Model HD9690 Rear Panel Layout.....	2-1
Figure 2-2:	Model HD9690-444 Rear Panel Layout.....	2-1
Figure 2-3:	General Purpose I/O Schematic.....	2-6
Figure 3-1:	HD9690 Front Panel Layout.....	3-1
Figure 3-2:	HD9690-444 Front Panel Layout.....	3-1
Figure 3-3:	Overview of the HD9690 Setup Menu	3-5
Figure 3-4:	Overview of the HD9690-444 Setup Menu	3-5
Figure 3-5:	Mask Position and Size	3-15
Figure 4-1:	Desktop Remote Panel Layout.....	4-1
Figure 4-2:	Overview of the HD9690 Setup Menu	4-5
Figure 4-3:	Overview of the HD9690-444 Setup Menu	4-5
Figure 4-4:	Mask Position and Size	4-14
Figure 6-1:	High Definition Interlaced/Segmented Frame Video Format Parameters.....	6-1
Figure 6-2:	High Definition Progressive Video Format Parameters.....	6-2
Figure 6-3:	Digital Cinema Video Format Parameters	6-3
Figure 8-1:	Australian 1080i 16:9 HD transmission Safe Areas	8-2
Figure 8-2:	Australian 16:9 Shoot and Protect 4:3 Safe Areas for SD Analog Transmission.....	8-2
Figure 8-3:	Australian 16:9 Shoot and Protect 14:9 Safe Areas for SD Analog Transmission.....	8-3
Figure 8-4:	720p 16:9 HD Transmission Safe Areas	8-4

Tables

Table 2-1:	Remote CTL Port Pin Definitions.....	2-2
Table 2-2:	Remote Panel Port Pin Definitions	2-3
Table 2-3:	GPI/O Port Pin Definitions	2-3
Table 2-4:	Video Input Formats	2-4
Table 2-5:	Standard RJ45 Wiring Color Codes.....	2-5
Table 2-6:	Remote Control Panel Extender Cable.....	2-7

Table 3-1: 4:4:4 Colour Mode Processing	3-11
Table 3-2: Object Colour Palettes.....	3-11
Table 4-1: 4:4:4 Colour Mode Processing	4-9
Table 4-2: Object Colour Palettes.....	4-10

This page left intentionally blank

CHAPTER 1: OVERVIEW

TABLE OF CONTENTS

1. OVERVIEW	1-1
1.1. HOW TO USE THIS MANUAL	1-3
1.2. GLOSSARY	1-4
1.2.1. Graticule Generator Terminology/Definitions	1-7

Figures

Figure 1-1: HD9690 Block Diagram	1-2
Figure 1-2: HD9690-444 Block Diagram	1-3

This page left intentionally blank

1. OVERVIEW

The Evertz HD9690 series HDTV Graticule Generators are multi format digital video graticule generators that key various alignment markers and mattes over a source video picture in a wide variety of applications. The model HD9690-444 can be operated in a dual link mode for emerging 4:4:4 high definition applications, or a 4:2:2 mode for traditional high definition (1125 and 750 line) digital video. The model HD9690 can only be operated in a 4:2:2 mode for traditional high definition (1125 and 750 line) digital video. With the 3D option installed in the HD9690-444, it can be used for stereoscopic 4:2:2 HD applications or 4:4:4 high definition applications.



Throughout this manual the term “HD9690” or “HD9690 series” is used to refer to both versions. When features apply only to specific versions they will be listed explicitly (e.g. “HD9690 version” or “HD9690-444 version”).

Applications:

- alignment of film images to the video raster during film to tape transfer
- safe action and safe title and centre marker for locating action point of interest and title graphics
- aspect ratio measurements
- letterbox or side marker cropping for image formats that do not match the video raster size
- alignment of graphics objects
- video tape quality control measurements

The standard Graticule Generator version consists of a 1 RU chassis with integrated control panel. The Graticule Generator is also available in a remote control version, which has a blank front panel and either a rack mountable, or a desktop remote control panel.

Commonly used configurations, stored as factory presets simplify routine operation to just a few pushbuttons. The ability to customize these factory presets to your application and store them as *USER PRESETS*, gives the Graticule Generator tremendous flexibility while maintaining simple operation for day-to-day use.

Features:

- Automatically senses between 1080i/60, 1080i/50, 1080p/24, 1080p/24sF, 720P/60 and 720p/50 video formats and the 1/1.001 divisor versions where applicable
- Model HD9690 keys Graticule markers directly into 4:2:2 SMPTE ST 292-1 High Definition Serial digital video.
- Model HD9690-444 keys Graticule markers directly into SMPTE ST 372 and SMPTE ST 292-1 High Definition Serial digital video.
- Model HD9690-444 can be operated in 4:4:4 RGB or YCbCr dual link mode with 4:2:2 output or 4:2:2 single link mode – manual select or autodetect.
- Model HD9690-444 handles extended range (full scale) 4:4:4 RGB with conversion to full scale or legal ITU-R BT.709 YCbCr on the 4:2:2 single link output
- Model HD9690-444+3D keys Graticule markers directly into SMPTE 292-2 stereoscopic HD digital video signals and SMPTE ST 372 Dual Link 4:4:4 signals.
- DVI-I Output for display on flat screen or computer monitors
- Two rectangular boxes that can be independently resized reshaped and moved anywhere on raster.
- A grid consisting of horizontal and vertical line pairs that can be positioned independently or in pairs anywhere on the raster
- Programmable horizontal and vertical hard matte

- Adjustable *mask* starting line in vertical blanking interval to pass VANC data
- Two User programmable cross markers positionable anywhere on the raster
- Ellipse creation for aspect ratio
- Automatic creation of aspect ratios for *mask*, *box* and *ellipse* objects
- On screen display shows object size, position and aspect ratio
- Automatic centering of all objects or individual object by object control of centering
- Single button keyer On/off control
- Adjustable object brightness and colour
- Front panel lock-out control
- Easy to operate front panel menu system gives access to advanced object control features for the most demanding application, while limiting normal day to day use to just a few preset buttons.
- Factory Presets allow quick setup to common object placements on the raster.
- Ten User-definable presets with user definable labels and individual write protect allow unlimited customization to any requirement.
- Optional Rack mount or Desktop remote control chassis

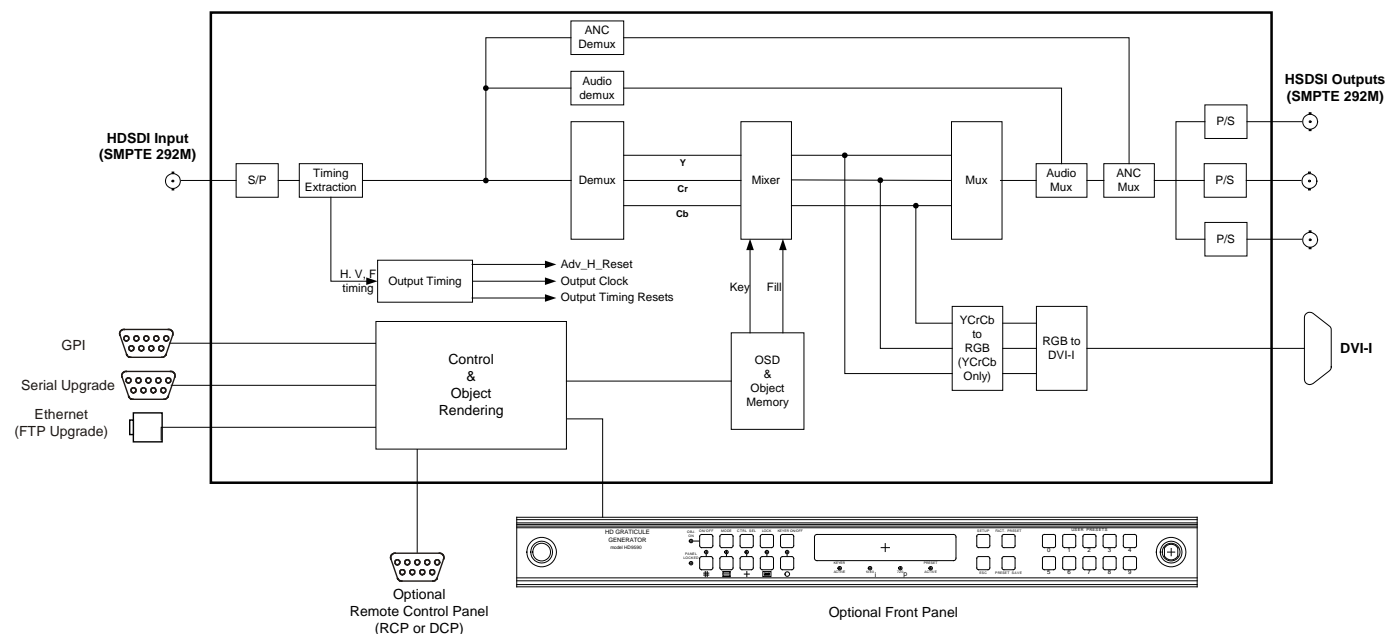

Figure 1-1: HD9690 Block Diagram

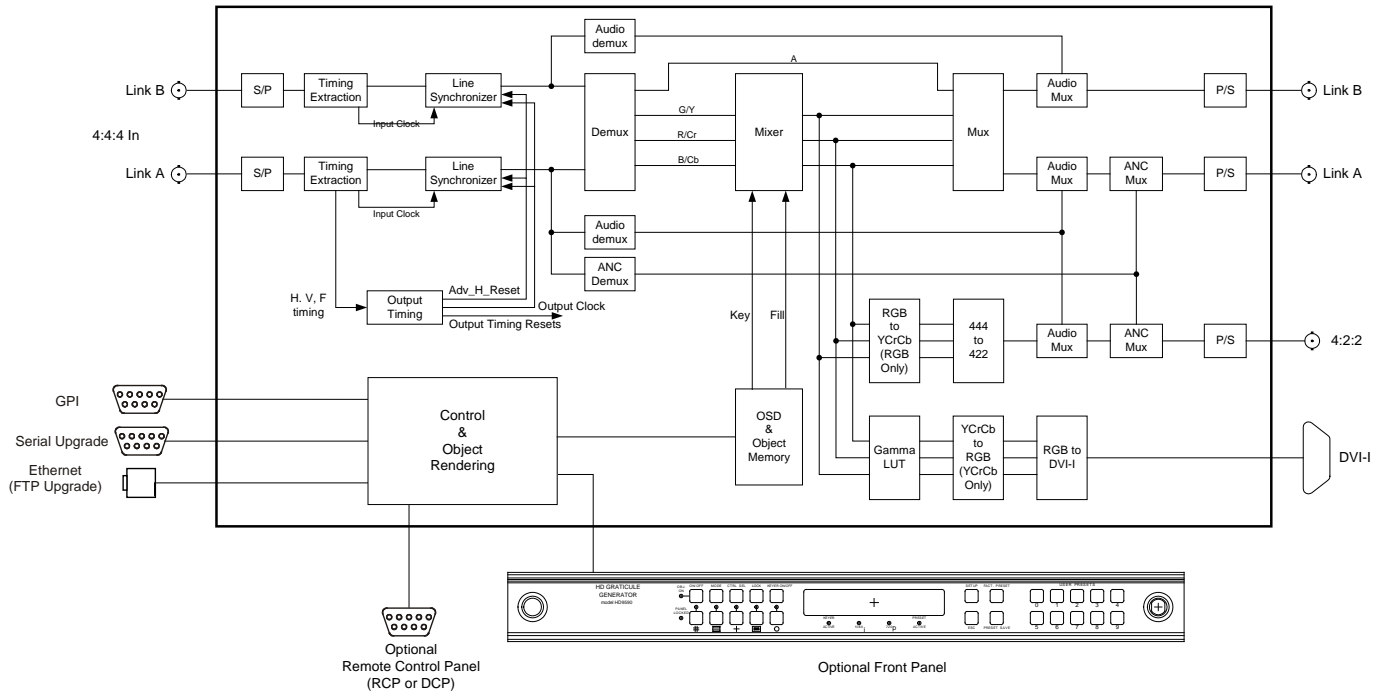

Figure 1-2: HD9690-444 Block Diagram

1.1. HOW TO USE THIS MANUAL

This manual is organised into 7 chapters: Overview, Installation, Front Panel Operation, Desktop Remote Panel Operation, Technical Description, Video Raster Definitions and Factory Presets. This chapter contains a quick summary of the features and a glossary to define concepts and terms used throughout the remainder of the manual.

Chapter 2 gives a detailed description of the rear panel connectors, and how the unit should be connected into your system.

Chapter 3 gives a detailed description of the operation of the front panel and Rack mount Remote Panel controls, starting with an overview of the pushbuttons and front panel indicators.

Chapter 4 gives a detailed description of the operation of the Desktop Remote Panel controls, starting with an overview of the pushbuttons and front panel indicators.

Chapter 5 gives the specifications, instructions on how to update the firmware in the unit and other technical issues.

Chapter 6 gives the specifications for the supported HDTV video rasters.

Chapter 7 gives a list of the details of each of the factory presets.



The exclamation point within an equi-lateral triangle is intended to alert the user to the presence of important safety related operating and maintenance (Servicing) instructions in the literature accompanying the product.



This symbol is intended to alert the user to important operating instructions.

1.2. GLOSSARY

- 4:2:2** A commonly used term for a component digital video format. The sampling details of high definition component digital video are specified in the ITU-R BT.709 standard. The numerals 4:2:2 denote the ratio of the sampling frequencies of the luminance channel to the two colour difference channels. For every four luminance samples, there are two samples of each colour difference channel. These signals are commonly carried on a coax cable according to the SMPTE ST 292-1 standard.
- 4:4:4** A commonly used term for a high resolution component digital video format. The numerals 4:4:4 denote the ratio of the sampling frequencies of the luminance channel to the two colour difference channels. For every four luminance samples, there are four samples of each colour difference channel. 4:4:4 sampled signals are also available in a RGB format with equal sampling rates for each of the colour channels. These signals are commonly carried on a pair of coax cables according to the SMPTE ST 372 standard.
- AES:** (Audio Engineering Society): A professional organization that recommends standards for the audio industries.
- AES/EBU:** Informal name for a digital audio standard established jointly by the Audio Engineering Society and the European Broadcasting Union organizations.
- ANALOG:** An adjective describing any signal that varies continuously as opposed to a digital signal that contains discrete levels representing digits 0 and 1.
- A-TO-D CONVERTER (ANALOG-TO-DIGITAL):** A circuit that uses digital sampling to convert an analog signal into a digital representation of that signal.
- BIT:** A binary representation of 0 or 1. One of the quantized levels of a pixel.
- BIT PARALLEL:** Byte-wise transmission of digital video down a multi-conductor cable where each pair of wires carries a single bit. This standard is covered under SMPTE 125M, EBU 3267-E and CCIR 656.
- BIT SERIAL:** Bit-wise transmission of digital video down a single conductor such as coaxial cable. May also be sent through fibre optics. This standard is covered under SMPTE 259M and CCIR 656.
- BIT STREAM:** A continuous series of bits transmitted on a line.
- BYTE:** A complete set of quantized levels containing all the bits. Bytes consisting of 8 to 10 bits per sample are typical in digital video systems.
- CABLE EQUALIZATION:** The process of altering the frequency response of a video amplifier to compensate for high frequency losses in coaxial cable.
- CCIR (International Radio Consultative Committee):** An international standards committee. (This organization is now known as the ITU.)

CLIFF EFFECT: (also referred to as the 'digital cliff') This is a phenomenon found in digital video systems that describes the sudden deterioration of picture quality due to excessive bit errors, often caused by excessive cable lengths. The digital signal will be perfect even though one of its signal parameters is approaching or passing the specified limits. At a given moment, however, the parameter will reach a point where the data can no longer be interpreted correctly and the picture will become totally unrecognisable.

COMPONENT ANALOG: The non-encoded output of a camera, video tape recorder, etc., consisting of the three primary colour signals: red, green, and blue (RGB) that together convey all necessary picture information. In some component video formats these three components have been translated into a luminance signal and two colour difference signals. For example: Y, B-Y, R-Y or more commonly referred to as YPbPr.

COMPONENT DIGITAL: A digital representation of a component analog signal set in either RGB or Y, B-Y, R-Y (or more commonly referred to as YcbCr) format. The encoding parameters for HD component video are specified by ITU-R Rec 709. SMPTE 274M and SMPTE 296M specify the parallel interface. SMPTE ST 292-1 specifies the serial interface for 4:2:2 sampled signals and SMPTE ST 372 specifies the serial interface for 4:4:4 samples signals.

EAV: Abbreviation for "End of Active Video". A digital synchronization sequence consisting of a sequence of four consecutive code words (a code word of all ones, a code word of all zeros, another code word of all zeros, and a code word including F (field/frame), V (vertical), H (horizontal), P3, P2, P1, and P0 (parity) bits.) which is used to designate the start of the horizontal blanking interval of the digital line. See also SAV.

EBU (European Broadcasting Union): An organization of European broadcasters that, among other activities, provides technical recommendations for the 50 hz television systems.

EMBEDDED AUDIO: Digital audio is multiplexed onto the high definition serial digital video bit stream according to the SMPTE 299M standard.

FSRGB Full Scale RGB, also known as *extended range RGB*. In high definition extended range RGB digital video, the three primary components are scaled such that the extreme values are code words 04_h (4) and $3FB_h$ (1019) in a 10-bit representation. See also RGB.

HDSDI An abbreviation for *high definition serial digital interface*, this acronym is most commonly used to refer to high definition serial digital television video signals at 1.485 Gb/s.

HDTV An abbreviation for *high definition television*, this acronym is most commonly used to refer to High definition serial digital television video signals at 1.485 Gb/s.

HEXADECIMAL Also abbreviated as **HEX**. Refers to the base-16 number system, which consists of 16 unique symbols: the numbers 0 to 9 and the letters A to F. Throughout this manual hexadecimal numbers will be denoted by an $_h$ suffix. For example, the decimal number 15 is represented as F_h in the hexadecimal numbering system. The hexadecimal system is useful because it can represent every byte (8 bits) as two consecutive hexadecimal digits. It is easier for humans to read hexadecimal numbers than binary numbers. To convert a value from hexadecimal to binary, you merely translate each hexadecimal digit into its 4-bit binary equivalent. For example, the hexadecimal number $3F7A_h$ translates to the binary number: 0011 1111 0111 1010.

ITU: The United Nations regulatory body governing all forms of communications. ITU-R (previously CCIR) regulates the radio frequency spectrum, while ITU-T (previously CCITT) deals with the telecommunications standards.

ITU-R BT.709 An international standard for component digital television from which was derived SMPTE 274M and SMPTE 296M standards. ITU-R BT.709 defines the sampling systems, matrix values and filter characteristics for Y, B-Y, R-Y and RGB high definition component digital television signals.

PIXEL: The smallest distinguishable and resolvable area in a video image. A single point on the screen. In digital video, a single sample of the picture. Derived from the words *picture element*.

RESOLUTION: The number of bits (four, eight, ten, etc.) determines the resolution of the signal. Eight bits is the minimum resolution for broadcast television signals.

4 bits = a resolution of 1 in 16.

8 bits = a resolution of 1 in 256.

10 bits = a resolution of 1 in 1024.

RGB The three primary colour signals: red, green, and blue (RGB) that together convey all necessary picture information. In normal high definition digital video, these three primary components are scaled such that the extreme values are code words 040_h (64) and 3AC_h (940) in a 10-bit representation. See also FSRGB.

SAV: Abbreviation for "Start of Active Video". A digital synchronization sequence consisting of a sequence of four consecutive code words (a code word of all ones, a code word of all zeros, another code word of all zeros, and a code word including F (field/frame), V (vertical), H (horizontal), P3, P2, P1, and P0 (parity) bits.) which is used to designate the end of the horizontal blanking interval. The pixel immediately following the SAV is known as pixel 0 and designates the first pixel of the specific line of the digital image. See also EAV.

SERIAL DIGITAL: Digital information that is transmitted in serial form. Often used informally to refer to serial digital television signals.

SMPTE (Society of Motion Picture and Television Engineers): A professional organization that recommends standards for the film and television industries.

SMPTE RP 218:2009: The legacy SMPTE Recommended Practice for Specifications for Safe Action and Safe Title Areas for Television Systems. This Recommended Practice provides the tools for calculating Safe Action and Safe Title Areas of any size. It also defines a set of Safe Areas, which are given in Annex B. These are legacy safe areas T based on the limitations of CRT-based displays. and are not reflective of current practice; for current practice, users should consult SMPTE ST 2046-1 and RP 2046-2.

SMPTE ST 292-1: The SMPTE standard for 4:2:2 sampled 1.5 Gb/s serial digital video interfaces.

SMPTE ST 299M: The SMPTE standard for embedding AES audio into HDTV SMPTE ST 292-1 and SMPTE ST 372 serial digital video interfaces.

SMPTE ST 372: The SMPTE standard for 4:4:4 sampled HDTV Dual Link 1.5 Gb/s serial digital video interfaces.

SMPTE ST 2046-1:2009: The new SMPTE Standard for Specifications for Safe Action and Safe Title Areas for Television Systems. These Current safe area specifications are based on fixed pixel matrix displays and are significantly larger than those specified in RP218,

SMPTE RP 2046-2:2009: The new SMPTE Recommended Practice specifying Safe Areas for Protection of Alternate Aspect Ratios. This practice specifies safe areas that should be used when composing 16:9 images that will be presented on both 4:3 and 16:9 aspect ratio displays. The choice of whether the image, having been captured in one aspect ratio, should be cropped for presentation in the other is dictated by creative and business factors. This Practice is intended to offer guidance on how best to compose the image once the presentation decision has been made

1.2.1. Graticule Generator Terminology/Definitions

CENTRE OF IMAGE The centre of an image is defined as the centre of the clean aperture. Horizontally there will be an equal number of pixels within the clean aperture to the left and right of the centre point. Vertically there will be an equal number of lines within the clean aperture above and below the centre point.

CLEAN APERTURE Is a subset region of the production aperture, which is concentric with the production aperture. The clean aperture is substantially free from transient effects due to blanking and picture processing.

EDGE PROCESSING REGION The region of the production aperture that lies outside the clean aperture. Blanking transitions should occur completely within the edge-processing region.

IMAGE ASPECT RATIO Defines the ratio of the horizontal dimension to the vertical dimension of the production aperture when displayed according to the specifications of the video standard. For HDTV images the image aspect ratio is 16:9.

IMAGE LATTICE A two-dimensional array of pixels.

OBJECT This is the object that is generated by the Graticule Generator and keyed into the video output. The Graticule Generator can generate the following objects: 1 grid consisting of a pair of horizontal lines and a pair of vertical lines, hard matte box, 2 cross markers, 2 boxes, and 1 ellipse.

OBJECT ASPECT RATIO Defines the ratio of the horizontal dimension to the vertical dimension of the graticule object keyed into an image, when the image is displayed at its defined aspect ratio.

OBJECT PARAMETER Each object has a set of parameters appropriate for the object. These parameters control the appearance, position and behaviour of the object on the screen. Some object parameters are mutually exclusive with others, so the menu structure intelligently shows only the object parameters that are available in the current mode.

OSD On Screen Display. This display can be overlaid on top of the video to view the object attributes of the controlled object.

ENABLED OBJECT An enabled object is one that is currently keyed into the video output.

SELECTED OBJECT The selected object is the one that will be controlled by the object parameter controls.

PIXEL ASPECT RATIO Defines the ratio of the horizontal dimension to the vertical dimension of a pixel when an image is displayed at its defined aspect ratio.

PRODUCTION APERTURE Is the Image Lattice that represents the maximum possible active image area in a given image format and is denoted as the number of active image pixels per horizontal row by the number of active image pixels per vertical column in a rectangular image area of any Aspect Ratio. The production aperture represents the desirable extent for image acquisition, generation and processing prior to blanking and is normally used as the basis for determining safe areas.

SAFE ACTION AREA Is the maximum image area within which all significant action shall be contained. The image area defined by the Safe Action Area is concentric with the Production Aperture. It is usually defined as a fixed percentage of the production aperture for a given video standard.

SAFE TITLE AREA Is the maximum image area within which all significant title and graphics information shall be contained to ensure visibility of the information on the majority of home television receivers. The image area defined by the Safe Title Area is concentric with the Production Aperture. It is defined as a fixed percentage of the production aperture for a given video standard.

PRESET Used to store the state of all objects in non-volatile storage for future use. When recalled from non-volatile storage. Factory presets are read only and are pre-configured at the factory. User presets are read/write with an optional write protect capability and can be customized by the user.

CHAPTER 2: INSTALLATION**TABLE OF CONTENTS**

2. INSTALLATION	2-1
2.1. REAR PANEL OVERVIEW	2-1
2.1.1. HD Video Connections (HD9690).....	2-1
2.1.2. HD Video Connections (HD9690-444).....	2-1
2.1.3. DVI Video Connections	2-2
2.1.4. Serial I/O and GPI/O Connections.....	2-2
2.1.5. Ethernet Network Connections.....	2-3
2.2. MOUNTING	2-3
2.3. POWER REQUIREMENTS	2-3
2.4. CONNECTING THE VIDEO	2-4
2.4.1. Video Inputs.....	2-4
2.4.2. Video Outputs	2-4
2.5. CONNECTING TO AN ETHERNET NETWORK	2-5
2.6. CONNECTING THE GENERAL PURPOSE INPUTS	2-6
2.7. CONNECTING THE REMOTE CONTROL PANEL (RCP AND DCP VERSIONS ONLY)	2-6

Figures

Figure 2-1: Model HD9690 Rear Panel Layout.....	2-1
Figure 2-2: Model HD9690-444 Rear Panel Layout.....	2-1
Figure 2-3: General Purpose I/O Schematic.....	2-6

Tables

Figure 2-1: Model HD9690 Rear Panel Layout.....	2-1
Figure 2-2: Model HD9690-444 Rear Panel Layout.....	2-1
Figure 2-3: General Purpose I/O Schematic.....	2-6



This page left intentionally blank

2. INSTALLATION

2.1. REAR PANEL OVERVIEW



Figure 2-1: Model HD9690 Rear Panel Layout



Figure 2-2: Model HD9690-444 Rear Panel Layout

Sections 2.1.1 to 2.1.5 describe the specific signals that should be connected to the units.

2.1.1. HD Video Connections (HD9690)

HD INPUT This two BNC connector is for connecting 4:2:2 10-bit serial digital video input signals, compatible with the SMPTE ST 292-1 standard.

HD OUTPUTS These three BNC connectors are contain the serial digital video output and contain the 4:2:2 input video with graticules.

2.1.2. HD Video Connections (HD9690-444)

HD INPUT A/4:2:2 and B These two BNC connectors are for connecting dual link 10-bit serial digital video input signals, compatible with the SMPTE ST 372 standard. When operating the Graticule generator in the 4:2:2 mode, connect the 4:2:2 input video compatible with the SMPTE ST 292-1 standard to the **A/4:2:2** inputs.

When the 3D option is fitted and operating the Graticule generator in the 4:2:2 mode, connect the stereoscopic 4:2:2 input video compatible with the SMPTE ST 292-2 standard to the **A/4:2:2** and **B** inputs. The Left Eye signal should be connected to the **A/4:2:2** input and the Right Eye signals should be connected to the **B** input.

HD OUTPUT A/4:2:2 and B These two BNC connectors are the main serial digital video output. When operating the Graticule generator in the 4:4:4 mode, the dual link Video with graticules will be available on these two output BNCs. When operating the Graticule generator in the 4:2:2 mode, the 4:2:2 video with graticules is available on the **A/4:2:2** output.

When the 3D option is fitted and operating the Graticule generator in the 4:2:2 mode, the stereoscopic 4:2:2 output video with graticules will be available on the **A/4:2:2** and **B** outputs. The Left Eye signal will be available on the **A/4:2:2** output and the Right Eye signal will be available on the **B** output.

HD OUTPUT 4:2:2 MON When operating the Graticule generator in the 4:4:4 mode, this BNC contains a down samples 4:2:2 copy of the output video with graticules. When operating the Graticule generator in the 4:2:2 mode this BNC contains a second copy of the input video with graticules. When the 3D option is fitted and operating the Graticule generator in the 4:2:2 mode this BNC contains a second copy of the Left Eye signal.

2.1.3. DVI Video Connections

DVI OUTPUT This VESA DVI-I connector provides progressive RGBHV and DVI-D outputs suitable for driving a computer video monitor. The monitor must be capable of scanning at the line and pixel rate of the video input standard you are using.

Recommended maximum cable lengths:

- DVI digital max length = 3 meters, or 10 feet
- VGA analog max length = 5 meters, or 15 feet

2.1.4. Serial I/O and GPI/O Connections

UPGRADE/COM1 This 9 pin female D connector provides an RS-232 serial interface used for updating the firmware. This port is wired at the factory as an RS232 DCE port as shown in Table 2-1.

	Pin #	Name	Description
	1	GND	Chassis ground
	2	TxD	RS-232 Transmit Output
	3	RxD	RS-232 Receive Input
	4		
	5	Sig Gnd	RS-232 Signal Ground
	6		
	7	RTS	RS-232 RTS Input
	8	CTS	RS-232 CTS Output
	9		

Table 2-1: Remote CTL Port Pin Definitions

REMOTE PANEL This female 9 pin D connector is for the RS-422 serial interface to the optional remote control panel. This connector is not installed on units with integrated control panels. See 2.7 for information about connecting the remote panel to the main unit.

	Pin #	Name	Description
	1	GND	Chassis ground
	2	TX-	RS-422 Transmit – Output
	3	RX+	RS-422 Receive + Input
	4		
	5		
	6	GND	Transmit ground
	7	TX+	RS-422 Transmit + Output
	8	RX-	RS-422 Receive – Input
	9		

Table 2-2: Remote Panel Port Pin Definitions

GPI/O

This female 9 pin D connector provides 8 General Purpose Opto-isolated inputs (GPIs). Table 2-3 shows the pin definitions of the GPIO connector. Figure 2-3 shows a schematic of the GPI circuitry. See section 2.6 for more information on connecting the General Purpose inputs and outputs. The GPIs are used as an alternate way to load 8 of the user presets

	Pin #	Name	Description
	1	GPI1	User preset 0
	2	GPI2	User preset 1
	3	GPI3	User preset 2
	4	GPI4	User preset 3
	5	GPI5	User preset 4
	6	GPI6	User preset 5
	7	GPI7	User preset 6
	8	GPI8	User preset 7
	9	GND	GND

Table 2-3: GPI/O Port Pin Definitions

2.1.5. Ethernet Network Connections

ETHERNET This RJ-45 connector is an Ethernet port used for high speed FTP firmware upgrades. See section 2.5 for information on connecting to an Ethernet network. See section 5.3.1 for information on upgrading firmware using FTP.

2.2. MOUNTING

The HD9690 is equipped with rack mounting angles and fit into a standard 19 inches by 1.75 inches (483 mm x 45 mm) rack space. The mounting angles may be removed if rack mounting is not desired.

2.3. POWER REQUIREMENTS

Power requirements are 100 to 240 volts AC at 50 or 60 Hz. The HD9690 has a universal power supply that automatically senses the input voltage. Power should be applied by connecting a 3-wire grounding type power supply cord to the power entry module on the rear panel. The power cord should be minimum 18 AWG wire size; type SVT marked VW-1, maximum 2.5 m in length.

The power entry module combines a standard power inlet connector, two 5 x 20 mm fuse holders and an EMI line filter. See section 5.2.1 for information about changing the fuses.



CAUTION - To reduce the risk of electric shock, grounding of the centre pin of the mains plug must be maintained

2.4. CONNECTING THE VIDEO

2.4.1. Video Inputs

On the HD9690 version the program video source should be connected to the **HD INPUT** BNC connector. On the HD9690-444 version the program video source should be connected to the **HD INPUT A/4:2:2** and **B** BNCs. The HD9690 series graticule generators support high definition digital video in the formats shown Table 2-4. In most cases the video standard is automatically detected.

Common Name	Pixels / Active Lines	Frame Rate	Progressive /Interlace	SMPTE Standard
1080i/60	1920 x 1080	30	I	274M
1080i/59.94	1920 x 1080	29.97 (30/1.001)	I	274M
1080i/50	1920 x 1080	25	I	274M
1080p/30sF	1920 x 1080	30	P (sF)	274M
1080p/29.97sF	1920 x 1080	29.97 (30/1.001)	P (sF)	274M
1080p/25sF	1920 x 1080	25	P (sF)	274M
1080p/23.98sF	1920 x 1080	23.98 (24/1.001)	P (sF)	274M
720p/60	1280 x 720	60	P	296M
720p/59.94	1280 x 720	59.94 (60/1.001)	P	296M
720p/50	1280 x 720	50	P	296M
2048x1080p/23.98sF	2048 x 1080	23.98 (24/1.001)	P (sF)	428M

Table 2-4: Video Input Formats

2.4.2. Video Outputs

On the HD9690 version there are three identical video outputs from the Graticule generator on the three **HD OUTPUT** BNCs.

On the HD9690-444 version the main video output from the Graticule generator is the **HD OUTPUT A/4:2:2** and **B** BNCs. When you are operating in the 4:4:4 mode, there is a 4:2:2 version of the main program output available on the **4:2:2 MON** BNC. When you have the 3D option fitted and are operating in 4:2:2 mode, you will have the Left Eye and Right Eye outputs on the **A/4:2:2** and **B** BNCs respectively.

There is also a DVI-I output available on the DVI connector. This output can be connected to analog RGB monitors using the DVI to RGB adapter supplied. (Additional DVI to VGA adaptors can be ordered from Evertz – part number JDVIVGAMF). This output may also be connected to DVI-D capable monitors that support the video resolution you are using (1920 x 1080 or 720 x 1280).

2.5. CONNECTING TO AN ETHERNET NETWORK

The HD9690 is designed to be used with either 10Base-T (10 Mbps) or 100Base-TX (100 Mbps) also known as *Fast Ethernet*, twisted pair Ethernet cabling systems. When connecting for 10Base-T systems, category 3, 4, or 5 UTP cable as well as EIA/TIA – 568 100Ω STP cable may be used. When connecting for 100Base-TX systems, category 5 UTP cable is required. Make the network connection by plugging one end of a “straight through” cable into the RJ-45 receptacle of the HD9690 and the other end into a port of the supporting hub. If you are connecting the HD9690 directly to an Ethernet port on a computer you will have to use a “crossover” cable.

The straight-through RJ-45 cable can be purchased or can be constructed using the pinout information in Table 2-5. A colour code wiring table is provided in Table 2-5 for the current RJ 45 standards (AT&T 258A or EIA/TIA 258B colour coding shown). Also refer to the notes following the table for additional wiring guide information.

Pin #	Signal	EIA/TIA 568A	AT&T 258A or EIA/TIA 568B	10BaseT or 100BaseT
1	Transmit +	White/Green	White/Orange	X
2	Transmit –	Green/White or White	Orange/White or Orange	X
3	Receive +	White/Orange	White/Green	X
4	N/A	Blue/White or Blue	Blue/White or Blue	Not used (required)
5	N/A	White/Blue	White/Blue	Not used (required)
6	Receive –	Orange/White or Orange	Green/White or Green	X
7	N/A	White/Brown	White/Brown	Not used (required)
8	N/A	Brown/White or Brown	Brown/White or Brown	Not used (required)

Table 2-5: Standard RJ45 Wiring Color Codes

Note the following cabling information for this wiring guide:

- Only two pairs of wires are used in the 8-pin RJ 45 connector to carry Ethernet signals.
- Even though pins 4, 5, 7 and 8 are not used, it is mandatory that they be present in the cable.
- 10BaseT and 100BaseT use the same pins, a crossover cable made for one will also work with the other.
- Pairs may be solid colours and not have a stripe.
- Category 5 cables must use Category 5 rated connectors.

The maximum cable run between the HD9690 and the supporting hub is 300 ft (90 m). The maximum combined cable run between any two end points (i.e. HD9690 and PC/laptop via network hub) is 675 feet (205 m).

Devices on the Ethernet network continually monitor the receive data path for activity as a means of checking that the link is working correctly. When the network is idle, the devices also send a link test

signal to one another to verify link integrity. The rear panel is fitted with two LEDs to monitor the Ethernet connection.

10/100 This Amber LED is ON when a 100Base-TX link is last detected. The LED is OFF when a 10Base-T link is last detected (the LINK LED is ON). Upon power-up the LED is OFF as the last detected rate is not known and therefore defaults to the 10Base-T state until rate detection is completed.

LN/ACT This dual purpose Green LED indicates that the HD9690 has established a valid linkage to its hub, and whether the HD9690 is sending or receiving data. This LED will be ON when the HD9690 has established a good link to its supporting hub. This gives you a good indication that the segment is wired correctly. The LED will BLINK when the HD9690 is sending or receiving data. The LED will be OFF if there is no valid connection.

In order to use the Ethernet connection you will have to configure the IP addresses for your network. See sections 5.3.1.1 and 5.3.1.2.

2.6. CONNECTING THE GENERAL PURPOSE INPUTS

The 9 pin GPI connector has 8 programmable general purpose inputs (GPI) as shown in Table 2-3. The schematic representation is in Figure 2-3. The GPI's are used as an additional way to activate the user presets. The GPI inputs are active low, which means a ground level on the input will activate the preset when the Opto isolator is normally powered.

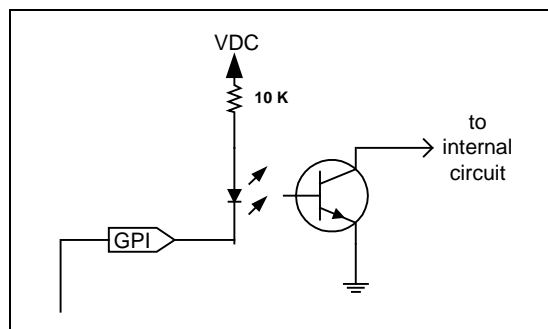

Figure 2-3: General Purpose I/O Schematic

2.7. CONNECTING THE REMOTE CONTROL PANEL (RCP AND DCP VERSIONS ONLY)

The Graticule Generator can be sold with integrated front panel control, or with a rack mountable or desktop remote control panel. When the units are shipped with the remote panel, the front panel of the unit has only the PSU Status indicator.

The **REMOTE PANEL** 9 pin D connector on the rear panel is used to connect the remote control panel to the main electronics unit. The 9 pin straight through cable provided can be used to connect the remote panel to the graticule generator. For longer distances, simply make your own cable of the required length according to the diagram in Table 2-6. Communications to the remote panel is through an RS-422 connection, so the panel can be located up to 1000 feet from the main electronics unit. A plug in 12 VDC adapter supplies power for the remote control panel.

Grat Gen End			Remote Panel End	
9 pin D Male	Pin	Belden 9729	9 pin D Female	Pin
	1			1
Tx-	2	-----1a-----	Rx-	2
Rx+	3	-----2b-----	Tx+	3
Rx Gnd	4	---drain 2----	RxGnd	4
	5			
Tx Gnd	6	---drain-1----	TxGnd	6
Tx+	7	-----1b-----	Rx+	7
Rx-	8	-----2a-----	Tx-	8
	9			9
Frame Gnd	Shield	---drain-1----	Frame Gnd	Shield

Table 2-6: Remote Control Panel Extender Cable



This page left intentionally blank

CHAPTER 3: OPERATION

TABLE OF CONTENTS

3. HOW TO OPERATE THE GRATICULE GENERATOR USING THE RACK MOUNT CONTROL PANEL	3-1
3.1. AN OVERVIEW OF THE KEY AND DISPLAY FUNCTIONS.....	3-1
3.1.1. The Object Pushbutton Group	3-2
3.1.2. The Setup Button Group.....	3-2
3.1.3. The Preset Button Group.....	3-3
3.1.4. Shaft Encoders (Knobs)	3-3
3.1.5. Status Indicators.....	3-4
3.1.6. Front Panel Display Messages	3-4
3.2. SETUP MENU	3-5
3.2.1. Choosing the Raster limits for the Mask Aspect Ratio and Size Calculation	3-6
3.2.2. Choosing the Raster limits for the Box Size Calculation	3-6
3.2.3. Choosing the Object Blink Time	3-6
3.2.4. Choosing How Line Numbers are Displayed	3-7
3.2.5. Displaying Object Aspect Ratio or Position on the Front Panel.....	3-7
3.2.6. Forcing all Objects to be Centred on the Raster	3-7
3.2.7. Setting how long the On Screen Display will be Active	3-8
3.2.8. Selecting the On Screen Display Position.....	3-8
3.2.9. Selecting the SMPTE Safe Area Specification.....	3-8
3.2.10. Operating the HD9690 in Auto Video Standard Mode.....	3-8
3.2.11. Selecting the Video Type (Model HD9690-444 only)	3-9
3.2.12. Selecting the 4:4:4 Colour Space (Model HD9690-444 only)	3-9
3.3. CONTROLLING THE INDIVIDUAL OBJECTS.....	3-11
3.3.1. Controlling the Object Modes	3-11
3.3.1.1. Display Mode	3-12
3.3.1.2. Centre Mode	3-12
3.3.2. Aspect Ratio Mode	3-12
3.3.3. Controlling the Object Attributes	3-12
3.3.4. Front Panel Display when Controlling the Objects	3-13
3.3.5. On Screen Display when Controlling the Objects	3-13
3.4. CONTROLLING THE GRID OBJECT	3-13
3.4.1. Turning the <i>Grid</i> Object On and Off	3-13
3.4.2. Controlling the <i>Grid</i> Modes.....	3-14
3.4.2.1. Centering the <i>Grid</i> on the Raster.....	3-14
3.4.3. Controlling the <i>Grid</i> Attributes.....	3-14
3.4.3.1. Controlling the <i>Grid</i> Colour.....	3-14
3.4.3.2. Controlling the <i>Grid</i> Line Width	3-14
3.4.3.3. Controlling the <i>Grid</i> Size (<i>Grid</i> Centred).....	3-15
3.4.3.4. Controlling the <i>Grid</i> Size and Position (<i>Grid</i> not centred)	3-15
3.5. CONTROLLING THE MASK OBJECT	3-15
3.5.1. Turning the Mask Object On and Off	3-16
3.5.2. Controlling the <i>Mask</i> Modes	3-16
3.5.2.1. Controlling the Aspect Ratio of the <i>Mask</i>	3-16
3.5.2.2. Centering the Mask on the Raster.....	3-16
3.5.2.3. Controlling the Opacity (Transparency) of the <i>Mask</i>	3-17

3.5.3.	Controlling the <i>Mask</i> Attributes.....	3-17
3.5.3.1.	Controlling the <i>Mask</i> Colour.....	3-17
3.5.3.2.	Controlling the <i>Mask</i> Size (<i>Mask</i> Centred, Aspect Ratio Off)	3-17
3.5.3.3.	Controlling the <i>Mask</i> Size (<i>Mask</i> Centred, Aspect Ratio On)	3-18
3.5.3.4.	Controlling the <i>Mask</i> Size and Position (<i>Mask</i> not centred, Aspect Ratio Off)	3-18
3.5.3.5.	Controlling the <i>Mask</i> Size and Position (<i>Mask</i> not centred, Aspect Ratio On)	3-18
3.6.	CONTROLLING THE CURSOR OBJECTS.....	3-19
3.6.1.	Turning the <i>Cursor</i> Objects On and Off	3-19
3.6.2.	Controlling the <i>Cursor</i> Modes	3-19
3.6.2.1.	Centering the <i>Cursor</i> on the Raster	3-19
3.6.3.	Controlling the <i>Cursor</i> Attributes.....	3-20
3.6.3.1.	Controlling the <i>Cursor</i> Colour.....	3-20
3.6.3.2.	Controlling the <i>Cursor</i> Line Width	3-20
3.6.3.3.	Controlling the <i>Cursor</i> Size	3-20
3.6.3.4.	Controlling the <i>Cursor</i> Position (<i>Cursor</i> not centred)	3-20
3.7.	CONTROLLING THE BOX OBJECTS	3-20
3.7.1.	Turning the Box Objects On and Off.....	3-21
3.7.2.	Controlling the <i>Box</i> Modes	3-21
3.7.2.1.	Controlling the Aspect Ratio of the <i>Box</i>	3-21
3.7.2.2.	Choosing a Solid or Dashed Box	3-21
3.7.2.3.	Centering the <i>Box</i> on the Raster	3-21
3.7.3.	Controlling the <i>Box</i> Attributes	3-22
3.7.3.1.	Controlling the <i>Box</i> Colour	3-22
3.7.3.2.	Controlling the <i>Box</i> Line Width.....	3-22
3.7.3.3.	Controlling the <i>Box</i> Size (<i>Box</i> Centred, Aspect Ratio Off)	3-22
3.7.3.4.	Controlling the <i>Box</i> Size and Position (<i>Box</i> centred, Aspect Ratio On).....	3-23
3.7.3.5.	Controlling the <i>Box</i> Size and Position (<i>Box</i> not centred, Aspect Ratio Off).....	3-23
3.7.3.6.	Controlling the <i>Box</i> Size and Position (<i>Box</i> not centred, Aspect Ratio On).....	3-23
3.8.	CONTROLLING THE ELLIPSE OBJECT	3-24
3.8.1.	Turning the <i>Ellipse</i> Object On and Off	3-24
3.8.2.	Controlling the <i>Ellipse</i> Modes	3-24
3.8.2.1.	Controlling the Aspect Ratio of the <i>Ellipse</i>	3-24
3.8.2.2.	Centering the <i>Ellipse</i> on the Raster.....	3-24
3.8.3.	Controlling the <i>Ellipse</i> Attributes.....	3-25
3.8.3.1.	Controlling the <i>Ellipse</i> Colour	3-25
3.8.3.2.	Controlling the <i>Ellipse</i> Line Width.....	3-25
3.8.3.3.	Controlling the <i>Ellipse</i> Size (<i>Ellipse</i> Centred, Aspect Ratio Off).....	3-25
3.8.3.4.	Controlling the <i>Ellipse</i> Size and Position (<i>Ellipse</i> centred, Aspect Ratio On)	3-25
3.8.3.5.	Controlling the <i>Ellipse</i> Size and Position (<i>Ellipse</i> not centred, Aspect Ratio Off)	3-26
3.8.3.6.	Controlling the <i>Ellipse</i> Size and Position (<i>Ellipse</i> not centred, Aspect Ratio On)	3-26
3.9.	LOADING FACTORY PRESETS.....	3-26
3.10.	WORKING WITH THE USER PRESETS.....	3-26
3.10.1.	Saving User Presets.....	3-27
3.10.2.	Recalling User Presets	3-27
3.10.3.	Customizing the User Preset Names.....	3-27

Figures

Figure 3-1: HD9690 Front Panel Layout	3-1
Figure 3-2: HD9690-444 Front Panel Layout	3-1
Figure 3-3: Overview of the HD9690 Setup Menu	3-5
Figure 3-4: Overview of the HD9690-444 Setup Menu	3-5
Figure 3-5: Mask Position and Size	3-15

Tables

Table 3-1: 4:4:4 Colour Mode Processing	3-11
Table 3-2: Object Colour Palettes.....	3-11

This page left intentionally blank

3. HOW TO OPERATE THE GRATICULE GENERATOR USING THE RACK MOUNT CONTROL PANEL

The Evertz HD9690 series HDTV Graticule Generators are multi format digital video graticule generators that key various alignment markers and mattes over a source video picture in a wide variety of applications. The model HD9690-444 can be operated in a dual link mode for emerging 4:4:4 high definition applications, or a 4:2:2 mode for traditional high definition (1125 and 750 line) digital video. The model HD9690 can only be operated in a 4:2:2 mode for traditional high definition (1125 and 750 line) digital video. Operation of the two versions of the Graticule generator are identical except where noted.



Throughout this manual the term “HD9690” or “HD9690 series” is used to refer to both versions. When features apply only to specific versions they will be listed explicitly (e.g. “HD9690 version” or “HD9690-444 version”).

The standard Graticule Generator version consists of a 1 RU chassis with integrated control panel. The Graticule Generator is also available in a remote control version, which has a blank front panel and either a rack mountable, or a desktop remote control panel. Operation of the Graticule Generator from the integrated control panel or the rack mount control panel is identical and is described in this chapter. For information on controlling the Graticule Generator from the desktop remote panel see chapter 4. For information about connecting the rack mount remote panel to the Graticule Generator electronics see section 2.7

3.1. AN OVERVIEW OF THE KEY AND DISPLAY FUNCTIONS

The display area consists of a 16 digit alphanumeric display, 11 LED status indicators and a 24 pushbutton keypad.

The keypad is used to select and control the attributes, position and size of each of the Graticule Generator objects. The Setup menu provides a means of setting overall constraints on the Graticule Generator, allowing you to configure the device to your application. Ten user preset buttons and one factory preset button allow you to save and recall frequently used collections of objects, to simplify operation of the Graticule Generator.

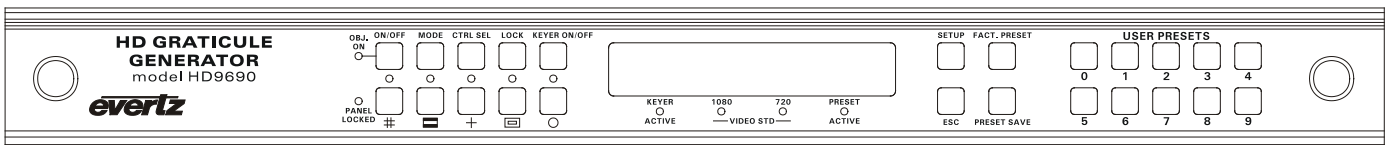

Figure 3-1: HD9690 Front Panel Layout

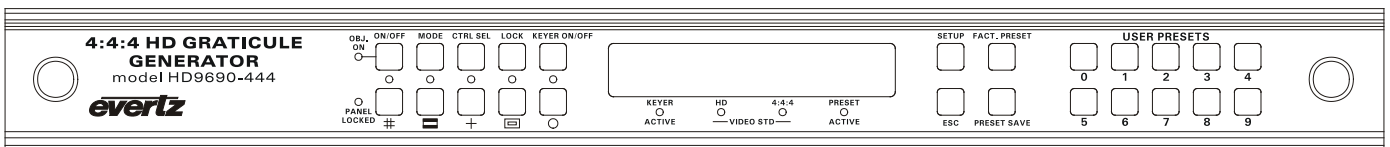



Figure 3-2: HD9690-444 Front Panel Layout

The remainder of this section gives an overview of each of the front panel buttons. Sections 3.3 to 3.8 give detailed information on controlling each of the screen objects.

3.1.1. The Object Pushbutton Group

The Object key group consists of the **ON/OFF**, **MODE**, **CTRL SEL**, **LOCK**, **KEYER ON/OFF**, and five object keys. The object key group is used to select individual objects and control their behaviours on the screen.

- GRID**  Pressing this button selects the *grid object*.

- MASK**  Pressing this button selects the *mask object*

- CURSOR**  Pressing the button once selects the first *cursor object*. Pressing the button a second time selects the second *cursor object*

- BOX**  Pressing the button once selects the first *box object*. Pressing the button a second time selects the second *box object*

- ELLIPSE**  Pressing this button selects the *ellipse object*

- ON/OFF** This button turns a particular *object ON* or *OFF*. If the *object* is set to *ON* you will see it in the output video. If the *object* is set to *OFF* you will not see it in the output video.

The *ON/OFF* status of each *object* is stored individually. You must select the *object* before you can change its *ON/OFF* status.

- MODE** This button controls various *MODES* for a particular *object* such as the aspect ratio and whether it is centred on the screen or not. Some of the *MODES* are automatically determined by the *setup* menu items, and may be hidden if they are not applicable. You must select the *object* before you can change its *MODE*.

- CTRL SEL** This button controls which attributes for a particular object (colour, line width, position, size or shape) will be adjusted by turning the shaft encoder knobs. Some of the object controls are affected by the setup menu items, and the object mode, and may be hidden if they are not applicable. You must select the *object* before you can change its *CTRL SELECTION*.

- LOCK** Pressing the *LOCK* button initiates a global panel lock. All front panel controls except the *LOCK* button are inhibited when *LOCK* is enabled. When the panel is *LOCKED* the *PANEL LOCKED* LED illuminates. Pressing the *LOCK* button will toggle the *LOCK* state *ON* and *OFF*.

- KEYER ON/OFF** Pressing this button allows the user to toggle the global *KEYER* state *ON (enabled)* and *OFF (disabled)*. When the *KEYER* is *ON* all enabled *objects* will be present in the video output. When the *KEYER* is *OFF* none of the enabled *OBJECTS* will be present in the video output.

3.1.2. The Setup Button Group

- SETUP** Pressing this button allows you to program various global attributes for the objects, and to configure the overall operating modes for the Graticule Generator. See section 4.1.6 for a complete description of the setup modes.

- ESC** This button is used to exit out of menus or to abort setup operations.

3.1.3. The Preset Button Group

The Preset key group consists of the **FACT PRESET** and **PRESET SAVE** buttons and ten **USER PRESET** buttons. The Preset key group is used to load one of the pre-programmed arrangements of object, or to save and recall up to ten different user setups.

FACT PRESET This button is used to recall the *factory presets*. Press this button to recall the *factory preset* that was previously selected. Turn one of the shaft encoder knobs to cycle through the available *factory presets*. The name of the selected preset will be shown on the front panel display, and the selected collection of object settings will be loaded into the Graticule Generator. The *PRESET ACTIVE* LED will illuminate when one of the *factory presets* is loaded. See section 3.9 for a description of each of the factory presets.



Factory presets cannot be recalled if the keyer is off.

PRESET SAVE This button allows the user to save the current *object* settings to one of the ten *user preset* memory locations. To save the current object settings to one of the *user preset* locations press the **PRESET SAVE** button once, then the desired the **USER PRESET** button. You will be prompted to press the **USER PRESET** button a second time to confirm the operation. Each of the *user preset* memory locations can be individually write-protected. See section 3.10 for a complete description of how to use the *user presets*.



User presets cannot be deleted directly from memory they can only be overwritten by another configuration saved to the same memory location.

USER PRESETS These ten buttons are used to store or recall the non-volatile *USER PRESETS*. To recall a *USER PRESET* press the corresponding button once. See section 3.9 for a complete description of how to use the *user presets*.



User presets cannot be recalled if the keyer is off.

3.1.4. Shaft Encoders (Knobs)

The shaft encoders' function is to change the value of one or more of the current object's parameters based on the current control option. When the mode or setup menus are enabled the shaft encoders are used to select menu options. The shaft encoders are also used to select the various *factory presets*.

When objects are being moved/resized on screen, the left knob controls horizontal movements, and the right knob controls vertical movements.

Horizontal move operations will be to the right for clockwise changes and to the left for counter-clockwise changes. Vertical move operations will be down for clockwise changes and up for counter-clockwise changes.

3.1.5. Status Indicators

There are 11 status indicators located on the front panel that show operational status of the Graticule Generator at a glance.

Most of the LED's are common to the Standard and High definition Graticule Generators. The LEDs above each of the object buttons indicate that the respective object is currently selected.

- OBJ ON** Indicates that selected *object* is turned on.
- PANEL LOCKED** Indicates that Graticule Generator front panel controls are locked against accidental changes.
- KEYER ACTIVE** Indicates that the Graticule Generator keyer is enabled. The enabled graticule objects will be keyed into the video path.
- PRESET ACTIVE** Indicates that one of the *factory presets* or *user presets* is currently in use. If any *object* parameter is modified, this LED will extinguish.

On the HD9690 version the video Standard LED's indicate what video standard the Graticule Generator is currently configured for.

- 1080** Indicates that the unit is currently operating in a 1080 active line standard and there is 1080 active line HD video present on the input.
- 720** Indicates that the unit is currently operating in a 720 active line standard and there is 720 active line HD video present on the input.

On the HD9690-444 version the video Standard LED's indicate what video type (4:2:2 or 4:4:4) the Graticule Generator is currently configured for.

- HD** Indicates that the unit is currently configured for operation with high definition video and there is HD video present on the Link A input.
- 4:4:4** Indicates that the unit is currently configured for operation with dual link 4:4:4 RGB or YCbCr video and there is dual link video present on the Link A and Link B inputs.

3.1.6. Front Panel Display Messages

In addition to the normal operating mode displays that show the names of the inputs that have been selected, the HD9690 cycles various diagnostic messages on the front panel display when there is no active object.

HD9690-444	Product Name
Version 1.00 b 1	Firmware version
Video = 1080I	Various messages indicating the video format detected
Video = Unknown	Indicates there is no video connected, or the video format is not supported by the Graticule generator

3.2. SETUP MENU

The key to the operational flexibility of the Graticule Generator lies in the *SETUP* menu system. The *SETUP* menu system uses the 16 digit alphanumeric display and provides a quick, intuitive method of configuring the Graticule Generator, guiding you to the correct setup for your application. The *SETUP* Menu contains items that pertain to the overall operation of the Graticule Generator. In addition each object is controlled by its own *MODE* and *CTRL SEL* settings. These context sensitive menus show only the items applicable to the selected object for the current *SETUP* settings. See sections 0 to 3.8 for information on controlling each of the objects through their *MODE* and *CTRL SEL* menus.

The two keys in the Setup key group (**SETUP**, **ESC**) and the two shaft encoders are used to cycle through the various items on the *SETUP* menu. The *SETUP* menu consists of a main menu with two or more choices for each menu item.

Safe Area =	2046	RP218					
--------------------	------	-------	--	--	--	--	--

Figure 3-3 and Figure 3-4 give an overview of the *SETUP* menu for the HD9690 and HD9690-444 versions respectively. The menu items are shown on the left with grey shading and the various choices are shown on the right with no background shading.

Mask apert =	prod	clean					
Box % apert=	prod	clean					
Obj blink =	short	long	none				
Ln disp =	int rel	int abs					
Feedback =	aspect	pos					
Force centre	yes	no					
OSD Timer =	Off	2 secs	5 secs	10 secs	30 secs	1 min	On
OSD Posn =	Top l	Top r	Bot l	Bot r	center		
Safe Area =	2046	RP218					

Figure 3-3: Overview of the HD9690 Setup Menu

Mask apert =	prod	clean					
Box % apert=	prod	clean					
Obj blink =	short	long	none				
Ln disp =	int rel	int abs					
Feedback =	aspect	pos					
Force centre	yes	no					
OSD Timer =	Off	2 secs	5 secs	10 secs	30 secs	1 min	On
OSD Posn =	Top l	Top r	Bot l	Bot r	center		
Safe Area =	2046	RP218					
Vid Type =	Auto	444 HD	422 HD				
444 Mode	ycbcr	rgb	fsfull	fsnorm			

Figure 3-4: Overview of the HD9690-444 Setup Menu

To enter the front panel programming menu, press the **SETUP** key. Pressing the **SETUP** key again allows you to move vertically down the *Setup* menu tree. You can also use the left shaft encoder knob to move vertically up and down the *Setup* menu tree. The menu item is shown on the left of the front panel display and the current value for that menu item is shown on the right. Turn the right shaft encoder knob to reveal the choices for the current menu item. When you have selected the desired sub menu choice press the **SETUP** key to save your choice and advance to the next menu item.



The menu choice that is shown for an item when you press the **SETUP** key or turn the left shaft encoder knob will be saved as the new value for that menu item. If you do not wish to save a new value press the **ESC** key to exit the **SETUP** menu.

When you have made all the desired changes, press the **ESC** key to return to the normal display mode. After a 30-second timeout, the Graticule Generator exits from the **SETUP** menu automatically.

Each of the menu items is described in the sections below, with an explanation of what each choice does.



When you make a change to one of the **SETUP** parameters you will need to press the **SETUP** button or turn the left shaft encoder knob to save the change.

3.2.1. Choosing the Raster limits for the Mask Aspect Ratio and Size Calculation

Mask apert =	prod	clean
--------------	------	-------

This menu item sets how the aspect ratio and size calculations for the *mask* and *grid* objects are calculated. In either setting, the *mask* and *grid* objects can be positioned all the way out to the *production aperture*. When you choose one of the automatic aspect ratios for the *mask* object, its initial size and position will be calculated with respect to the mask aperture setting. See section 3.5.2.1 for information on selecting the *mask* aspect ratio.

Select **prod** when you want to use the *production aperture* as the reference for the *mask* and *grid* object aspect ratio and size.

Select **clean** when you want to use the *clean aperture* as the reference for the *mask* and *grid* object aspect ratio and size.

3.2.2. Choosing the Raster limits for the Box Size Calculation

Box % apert=	prod	clean
--------------	------	-------

This menu item sets how the size percentage calculations for the *box* object are calculated. In either setting, the *box* object perimeter can be positioned all the way out to the *production aperture*.

Select **prod** when you want to use the *production aperture* as the reference for the *box* object size calculation.

Select **clean** when you want to use the *clean aperture* as the reference for the *box* object size calculation.

3.2.3. Choosing the Object Blink Time

Obj blink =	short	long	none
-------------	-------	------	------

This menu item sets how long objects blink when they are selected.

Select **long** when you want a selected object to blink for twenty seconds before it reverts back to being displayed continuously.

Select **short** when you want a selected object to blink for three seconds before it reverts back to being displayed continuously.

Select **none** when you want to disable object blinking.

3.2.4. Choosing How Line Numbers are Displayed

Ln disp =	int rel	int abs
-----------	---------	---------

When the selected video standard uses an interlaced raster, this menu item changes the format that the front panel display uses to show line numbers.

Select **int rel** to view line numbers in an *interlaced relative* format. In this format lines are numbered relative to the beginning of each *field* and shown with their field number. (E.g. in 1080 line video, line 21F1 is the first line of active video in field 1; line 21F2 is the first line of active video in field 2)

Select **int abs** to view line numbers in an *interlaced absolute* format. In this format lines are numbered in an interlaced raster with the line numbers relative to the beginning of the complete frame. (E.g. in 1080 line video, line 21 is the first line of active video in field 1; line 584 is the first line of active video in field 2)

When the video standard uses a progressive (non-interlaced) raster, this menu item is not available. Line numbering is always done in a progressive system referenced to the beginning of the frame.

3.2.5. Displaying Object Aspect Ratio or Position on the Front Panel

Feedback =	aspect	pos
------------	--------	-----

This menu item sets whether the front panel display will show the object aspect ratio or position when an object's size or position is being controlled. The on screen display will show both the aspect ratio, and the object size in pixels and lines as percentage of its aperture.

Select **aspect** when you want to show the object size as a percentage of its aperture.

Select **pos** when you want to show the object position as horizontal and vertical position values.

3.2.6. Forcing all Objects to be Centred on the Raster

Force centre	yes	no
--------------	-----	----

This menu item sets whether the *grid*, *mask*, *box* and *ellipse* objects are all always centred on the screen, or whether object centering will be individually controlled by their *object* modes. The *cursor* objects are **not** controlled by this menu item and must be centred using their individual *mode* settings.

Select **yes** to force the *grid*, *mask*, *box* and *ellipse* objects to be centred on the raster. The OSD will show *all objects centred*.

Select **no** to use the individual *mode* settings for the *grid*, *mask*, *box* and *ellipse* objects to control whether the objects are centred on the raster. The OSD will show the setting of the individual object's centre mode.

3.2.7. Setting how long the On Screen Display will be Active

OSD Timer =	Off	2 secs	5 secs	10 secs	30 secs	1 min	On
-------------	-----	--------	--------	---------	---------	-------	----

This menu item allows the user to control how long the on-screen display of the object attributes will be displayed. The on-screen display will turn off after the amount of time set by this menu item with no front panel activity. To turn off the on-screen display completely select **off**. To turn on the on-screen display all the time select **on**. The on screen aspect ratio display shows the position, aspect ratio and other attributes of the selected object.



The displayed aspect ratio may be slightly different than the target aspect ratio (selected by the object's aspect ratio mode) due to rounding of the dimensions to the closest line or pixel.

3.2.8. Selecting the On Screen Display Position

OSD Posn =	Top l	Top r	Bot l	Bot r	center
------------	-------	-------	-------	-------	--------

This menu item allows the user to set the area on the screen where the on-screen display will be shown. Turn the right shaft encoder to move the display to one of 5 positions on the screen.

3.2.9. Selecting the SMPTE Safe Area Specification

Safe Area =	2046	RP218			
-------------	------	-------	--	--	--

SMPTE has recently published a new safe area specification in SMTPE ST 2046-1 based on fixed pixel matrix displays and are significantly larger than previously specified in RP218, The safe areas specified in RP218 are a legacy of past practice and are based on the limitations of CRT-based displays. This menu item allows the user to set whether the SMPTE ST 2046 or RP218 safe area specifications will be used for the factory presets

3.2.10. Operating the HD9690 in Auto Video Standard Mode

The HD9690 operates in an auto video standard mode and will attempt to detect the video standard of the incoming video and change the current video standard to match. When the incoming video does not match the current standard, the Graticule Generator will switch to the new video standard after approximately 5 seconds. This delay prevents random standards switches that otherwise may occur between some of the video formats. The new video standard will be displayed on the front panel. Video standards changes will not occur while the Graticule Generator is in the *Setup* mode, or while the on screen objects are being moved using the shaft encoder knobs.

Most of the supported standards can be detected, but there are some exceptions.

- The standards 1080I and 1080PsF are the same as far as the Graticule Generator is concerned. When the video input is in either of these standards the Graticule generator will display the standard as 1080I. Exception: when the frame rate is 24 (23.98) the Graticule generator will display the standard as 1080PsF.

3.2.11. Selecting the Video Type (Model HD9690-444 only)

Vid Type=	Auto	444 HD	422 HD
-----------	------	--------	--------

This menu item selects the video type in use.

Select **AUTO** when you want the HD9690-444 to automatically detect the video type (444 HDSDI or 422 HDSDI) from the incoming video. The HD9690-444 will attempt to detect whether the incoming video is single link 4:2:2 or dual link 4:4:4 and change its internal colour space processing to match. When both Link A and Link B input BNCs have incoming video in the same standard the HD9690-444 will assume that the input video type is 4:4:4 dual link video conforming to the SMPTE ST 372 standard and the front panel 444 LED will be ON. The *444 Mode* menu item must be set to match the colour space of the incoming video. (see section 3.2.12) When only the Link A input BNC has incoming video, the HD9690-444 will assume that the input video type is 4:2:2 YCbCr conforming to the SMPTE ST 292-1 standard. The *444 Mode* menu item is ignored in this mode and the graticule generator will be configured for YCbCr colour processing.

Select **444HD** when you want the HD9690-444 to always operate with 4:4:4 HDSDI incoming video. You must connect a valid 4:4:4 video signal to the Link A and Link B input BNC connectors. The *444 Mode* menu item must be set to match the colour space of the incoming video.

Select **422HD** when you want the HD9690-444 to always operate with 4:2:2 HDSDI incoming video. You must connect a valid 4:2:2 video signal to the Link A BNC connectors. (Any signal connected to the Link B BNC is ignored) The *444 Mode* menu item is ignored in this mode and the graticule generator will be configured for YCbCr colour processing.

3.2.12. Selecting the 4:4:4 Colour Space (Model HD9690-444 only)

444 Mode	ycbcr	rgb	fsfull	fsnorm
----------	-------	-----	--------	--------

This menu item selects the colour processing that will be applied on the incoming video. It should be set to match the colour space of incoming 4:4:4 video. This menu item is not visible with 4:2:2 input video formats. See Table 3-1 for details of the four colour processing modes and Table 3-2 for the colour palette information.

Select **ycbcr** when the incoming video is in the 10 bit 4:4:4 YCbCr format. In the *ycbcr* mode, the RGB to YCrCb colour transformation for the 4:2:2 MON output will be disabled, the YCrCb to RGB colour transformation for the DVI output will be enabled and graticule objects will have normal colour values.

Select **rgb** when the incoming video is in the 10 bit 4:4:4 RGB format compliant with SMPTE 274M or SMPTE 296M and the 4:2:2 output is to be in the normal 10 bit YCbCr format. Both the RGB and YCrCb video has the three components scaled such that the extreme values are code words 040_h (64) and 3AC_h (940) in a 10-bit representation. In the *rgb* mode, the RGB to YCrCb colour transformation for the 4:2:2 MON output will be enabled, the YCrCb to RGB colour transformation for the DVI output will be disabled and graticule objects will have normal colour values.

Select **fsfull** when the incoming video is in the extended range 10 bit 4:4:4 FSRGB format and the 4:2:2 output is to be in the FSYCbCr format. Both the FSRGB and FSYCbCr video has the three components scaled such that the extreme values are code words 04_h (4) and $3FB_h$ (1019) in a 10-bit representation. In the *fsfs* mode, the FSRGB to FSYCrCb colour transformation for the 4:2:2 MON output will be enabled, the YCrCb to RGB colour transformation for the DVI output will be disabled and graticule objects will have full scale colour values.

Select **fsnorm** when the incoming video is in the extended range 10 bit 4:4:4 FSRGB format and the 4:2:2 output is to be in the normal YCbCr format. The FSRGB video has its three components scaled such that the extreme values are code words 04_h (4) and $3FB_h$ (1019) in a 10-bit representation. The YCrCb video has the three components scaled such that the extreme values are code words 040_h (64) and $3AC_h$ (940) in a 10-bit representation. In the *fsrgb* mode, the FSRGB to YCrCb colour transformation for the 4:2:2 MON output will be enabled, the FSRGB to RGB colour transformation for the DVI output will be enabled and graticule objects will have full scale colour values.

444 Mode	4:4:4 In/Out		4:2:2 Mon Out		DVI Out		Colour Palette
	Min	Max	Min	Max	Min	Max	
<i>ycrcb</i>	040 _h (64)	3AC _h (940)	040 _h (64)	3AC _h (940)	040 _h (64)	3AC _h (940)	Normal
<i>rgb</i>	040 _h (64)	3AC _h (940)	040 _h (64)	3AC _h (940)	040 _h (64)	3AC _h (940)	Normal
<i>fsfull</i>	04 _h (4)	3FB _h (1019)	04 _h (4)	3FB _h (1019)	04 _h (4)	3FB _h (1019)	Full Scale
<i>fsnorm</i>	04 _h (4)	3FB _h (1019)	040 _h (64)	3AC _h (940)	04 _h (4)	3FB _h (1019)	Full Scale

Table 3-1: 4:4:4 Colour Mode Processing

Colour	Normal Palette			Full Scale Palette		
	G	B	R	G	B	R
0 Black	040 _h (64)	040 _h (64)	040 _h (64)	04 _h (4)	04 _h (4)	04 _h (4)
1 25% Gray	11C _h (284)	11C _h (284)	11C _h (284)	100 _h (256)	100 _h (256)	100 _h (256)
2 50% Gray	1F8 _h (504)	1F8 _h (504)	1F8 _h (504)	200 _h (512)	200 _h (512)	200 _h (512)
3 75% Gray	204 _h (724)	204 _h (724)	204 _h (724)	300 _h (768)	300 _h (768)	300 _h (768)
4 White	3AC _h (940)	3AC _h (940)	3AC _h (940)	3FB _h (1019)	3FB _h (1019)	3FB _h (1019)
5 100% Red	040 _h (64)	040 _h (64)	3AC _h (940)	04 _h (4)	04 _h (4)	3FB _h (1019)
6 75% Red	040 _h (64)	040 _h (64)	204 _h (724)	04 _h (4)	04 _h (4)	300 _h (768)
7 100% Green	3AC _h (940)	040 _h (64)	040 _h (64)	3FB _h (1019)	04 _h (4)	04 _h (4)
8 75% Green	204 _h (724)	040 _h (64)	040 _h (64)	300 _h (768)	04 _h (4)	04 _h (4)
9 100% Blue	040 _h (64)	3AC _h (940)	040 _h (64)	04 _h (4)	3FB _h (1019)	04 _h (4)
10 75% Blue	040 _h (64)	204 _h (724)	040 _h (64)	04 _h (4)	300 _h (768)	04 _h (4)
11 100% Yellow	3AC _h (940)	040 _h (64)	3AC _h (940)	3FB _h (1019)	04 _h (4)	3FB _h (1019)
12 75% Yellow	204 _h (724)	040 _h (64)	204 _h (724)	300 _h (768)	04 _h (4)	300 _h (768)
13 100% Magenta	040 _h (64)	3AC _h (940)	3AC _h (940)	04 _h (4)	3FB _h (1019)	3FB _h (1019)
14 75% Magenta	040 _h (64)	204 _h (724)	204 _h (724)	04 _h (4)	300 _h (768)	300 _h (768)

Table 3-2: Object Colour Palettes

3.3. CONTROLLING THE INDIVIDUAL OBJECTS

The Graticule Generator has separate controls for each of its seven objects (*grid*, *mask*, *box1*, *box2*, *cursor1*, *cursor2*, and *ellipse*). To select the *object* press the corresponding button as described in section 3.1.1. To select the second object of a particular type (*box2* or *cursor2*) press the corresponding button a second time. The selected object will blink momentarily (if it is On and the *OBJ BLINK* item on the *SETUP* menu is enabled), and the on screen display will be automatically turned on if the *OSD TIMER* item on the *SETUP* menu is not set to *Off*. The LED above the button will come on indicating that the object is selected. To turn off the object, press the **ON/OFF** button when the LED is illuminated. All objects will be automatically de-selected after two minutes of inactivity on the front panel. Individual objects will also be deselected when another object is selected. The on screen display will show the object selected and whether it is on or off.

3.3.1. Controlling the Object Modes

When an object is selected the **MODE** button is used to control its modes (such as aspect ratio, and whether it is centred or not). Pressing the **MODE** button cycles through a list of possible modes for the currently selected object, and the shaft encoders will change the setting for that mode. After a 30-second timeout, the Graticule Generator exits from the *mode select* menu. If the **ESC** button is pressed, the Graticule Generator also exits from the *mode select* menu. When an object is selected, the last modes in use by that object are enabled.

3.3.1.1. Display Mode

Display modes are used to control the appearance of the object on the output video, ex. dashed and solid lines.

3.3.1.2. Centre Mode

If the object's centre mode is enabled, the object's centre will be fixed to the horizontal and vertical centre of the clean aperture. (The on screen display will show the setting of the object's centre mode.) The centre mode will not be available when the *Force Centre Setup Menu* item is set to *yes*. (The on screen display will show *all objects centred*.)

3.3.2. Aspect Ratio Mode

The aspect ratio mode of the *mask*, *box*, and *ellipse* objects forces the selected object's size parameters to follow one of the following fixed aspect ratios: 1:1, 4:3(1.33:1), 14:9 (1.55:1), 1.67:1, 16:9 (1.78:1), 1.85:1, 2.35:1. (The on screen display will show the aspect ratio as *fixed aspect*.) When the object aspect ratio is set to *Off* the object's dimensions are not constrained to follow a fixed aspect ratio. (The on screen display will show the aspect ratio as *user aspect*.)

When an object is being controlled in fixed aspect ratio mode, the horizontal size will be adjusted first, then the aspect ratio applied to determine the correct vertical size. The pixel aspect ratio and the object aspect ratio are both used to calculate the vertical size of an object of a given horizontal size. The following formula is used to calculate the vertical size:

$$\text{Number of V lines} = \text{Number of H pixels} \times (\text{Pixel aspect ratio} / \text{Object aspect ratio})$$

This calculation will be rounded to the closest line or to the closest line pair if object centering is on.

Example: Draw a box in 1080 video standard with an aspect ratio of 4:3, with a width of 708 pixels. The Pixel aspect ratio for 1080 HD formats is 1.00.

$$\begin{aligned} \text{V lines} &= \text{H pixels} \times (\text{Pixel AR} / \text{Object AR}) \\ &= 708 \times (1 / (4/3)) \\ &= 480 \end{aligned}$$

The selected object aspect ratio defines the ideal dimensions of the object. The on screen and front panel aspect ratio displays show the actual object aspect ratio rounded to 2 decimal places. It may vary slightly from the selected object aspect ratio due to the effects of rounding to the closest line, and object centering.

3.3.3. Controlling the Object Attributes

The **CTRL SEL** button is used to select which *object* attributes (colour, line width, size, position, etc.) will be adjusted using the shaft encoder knobs. The particular items available in the *CTRL SEL* menu are determined by settings in the *SETUP* menu and the object *MODES* in force at the time. The on screen display will show the active control on the *ctrl* line.

Sections 3.4 to 3.8 give a complete description of how to control each of the individual objects. In the sections describing the *CTRL SEL* items, the relevant settings from the *MODE* and *SETUP* menus are shown where necessary.

3.3.4. Front Panel Display when Controlling the Objects

When an object is selected the name of the selected object will appear on the display. After a 3-second timeout, the display will show the current value of the object parameters being controlled by the knobs (as determined by the *CTRL SEL* menu).

When the object is turned off by pressing the **ON/OFF** key, the Front display will show that the object is turned off. If the object is subsequently turned on, the front panel will indicate that it is on, then will show the object parameters after a 3-second timeout.

When object attributes are being modified by turning one of the shaft encoders, the attribute being controlled is displayed along with its current value.

3.3.5. On Screen Display when Controlling the Objects

When an object is selected the name and attributes of the selected object will appear on an on screen display (OSD). (unless the *OSD TIMER* menu item on the *Setup* menus is set to *Off*). The OSD can be located in one of 5 positions on the screen and shows the following attributes for the object:

Object name	(off on)		
Ctrl	Active Control name		
Centred	Object centering		
User aspect	Aspect ratio		
Aperture	Aperture applicable to object		
Width	Width in pixels (% of aperture width)		
Height	Height in lines (% of aperture height)		
Top	Object Top (raster line)	Btm	Object Bottom (line)
Left	Object left (pixel number)	Right	Object right(pixel)
Centre pos	Object centre position (line, pixel)		

When the object is turned off by pressing the **ON/OFF** key, the OSD will show that the object is turned off. When object attributes are being modified by turning one of the shaft encoders, the attribute being controlled is shown as the *active control name*.

3.4. CONTROLLING THE GRID OBJECT

The *grid* object consists of two horizontal lines and two vertical lines that intersect the horizontal lines. The lines are shaped to avoid sharp transitions in the video. Line width may be adjusted using the *Line Width* attribute. The locations of the grid lines shown is the centre of the line.

3.4.1. Turning the *Grid* Object On and Off

To select the *grid* object press the **GRID** button. The *grid* object will blink momentarily (if the *grid* is On and the *obj blink* item on the *Setup* menu is enabled) and the LED above the **GRID** button will come on indicating that the *grid* object is selected. The on screen display will be automatically turned on if the *OSD TIMER* item on the *SETUP* menu is not set to *Off* and will indicate it the *grid* object is On or Off. To turn the *grid* object Off or On, press the **ON/OFF** button when the LED is illuminated.

3.4.2. Controlling the *Grid* Modes

When the *grid* object is selected the **MODE** button is used to control whether it is centred or not. Press the **MODE** button until the desired mode item is shown on the front panel, along with the current setting. To select one of the other choices for that mode item, turn one of the shaft encoders knobs. When you have chosen the desired setting for the mode item press the **MODE** button again to save the new setting and view the next mode item. Continue pressing the **MODE** key until you see the message *Mode Select Off*. The shaft encoders revert to controlling the selected *attribute* for the *grid* that is also shown on the *ctrl* line of the OSD.

3.4.2.1. Centering the *Grid* on the Raster

Centre:	H + V	Off
---------	-------	-----

This item is used to control whether the *grid* object is centred on the raster or not. The *centre* item is only available when the *SETUP* menu item *force centre* is set to *off*.

Select **H + V** to force the *grid* object to be centred on the raster. The OSD will show *centred*.

Select **off** to allow the *grid* object to be moved off centre. The OSD will show *not centred*. In this *MODE* it is possible to independently position each line on the *grid*, or to position and size the whole *grid*, depending what *CTRL SEL* item is chosen.

3.4.3. Controlling the *Grid* Attributes

When the *grid* object is selected the **CTRL SEL** button is used to select which of its attributes (such as colour, line width, position, size, or individual lines of the object) will be adjusted by turning the shaft encoder knobs. Press the **CTRL SEL** button until the desired *CTRL SEL* item is shown on the front panel. When you have chosen the desired *CTRL SEL* item press the **GRID** button again or turn one of the shaft encoder knobs to begin controlling the selected attribute of the *grid*. The selected attribute for control will show on the *ctrl* line of the OSD.

The items that are shown in the *grid CTRL SEL* menu depend on the *MODE* settings and the settings in the *SETUP* menu. In the sections describing the *CTRL SEL* items, the relevant settings from the *grid MODE* and *SETUP* menus are shown where necessary.

3.4.3.1. Controlling the *Grid* Colour

Colour The colour of the *grid* object can be adjusted in the range of “0” through “14”, in single digit increments, using either shaft encoder. The colours that will be displayed for each value are shown in Table 3-2.

3.4.3.2. Controlling the *Grid* Line Width

Line Width	3	5	7	9	11
------------	---	---	---	---	----

Line Width The line width of the *grid* object can be adjusted in the range of “3” through “11”, in increments of two, using either shaft encoder. Only the pixels (lines) in the centre of the line width are keyed at 100%. The edges of the line are keyed at a reduced level to reduce aliasing.

3.4.3.3. Controlling the Grid Size (Grid Centred)

Setup menu	Force centre	no	or	Setup menu	Force centre	yes
Mode menu	Centre	H + V				

Size When the *grid* is centred, the left shaft encoder is used to adjust the height and the right shaft encoder is used to adjust the width of the *grid* about the centre of the raster.

3.4.3.4. Controlling the Grid Size and Position (Grid not centred)

Setup menu	Force centre	no
Mode menu	Centre	off

When the *grid* centering is Off the H and V lines can be positioned independently in one of four modes.

V track The left shaft encoder is used to adjust the vertical position of the *grid*, i.e. move the *grid* up or down and the right shaft encoder is used to adjust the height of the *grid*.

V no track The left shaft encoder is used to adjust the top of the *grid* and the right shaft encoder is used to adjust the bottom of the *grid*.

H track The left shaft encoder is used to adjust the horizontal position of the *grid*, i.e. move the *grid* left or right and the right shaft encoder is used to adjust the width of the *grid*.

H no track The left shaft encoder is used to adjust the left side of the *grid* and the right shaft encoder is used to adjust the right side of the *grid*.

3.5. CONTROLLING THE MASK OBJECT

The *mask* object consists of a horizontal masked area at the top and bottom of the raster, and a vertical masked area at the left and right side of the raster. Throughout the remainder of section 3.4.3.3 the *mask* dimensions refer to the boundaries between the masked and unmasked area as shown in Figure 3-5. The left side of the mask is the first unmasked pixel, the right side is the last unmasked pixel. The top of the mask is the first unmasked line and the bottom of the mask is the last unmasked line. The horizontal transitions from mask to image are shaped as shown in Figure 3-5. The vertical transitions from mask to image are hard transitions.

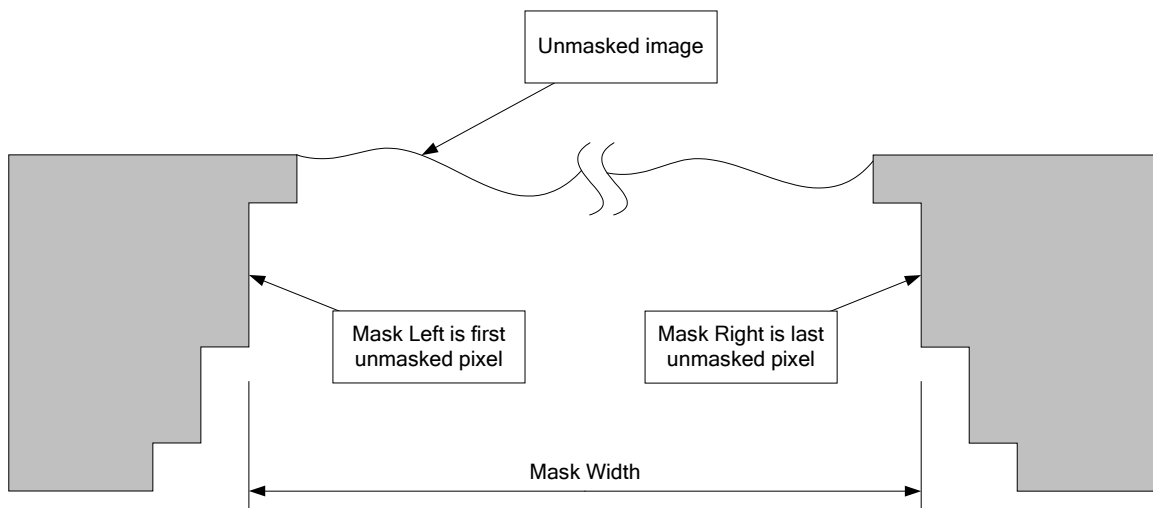

Figure 3-5: Mask Position and Size

3.5.1. Turning the Mask Object On and Off

To select the *mask* object press the **MASK** button. A dashed line at the edge of the *mask* object will blink momentarily (if the *mask* is On and the *obj blink* item on the *Setup* menu is enabled) and the LED above the **MASK** button will come on indicating that the *mask* object is selected. The on screen display will be automatically turned on if the *OSD TIMER* item on the *SETUP* menu is not set to *Off* and will indicate if the *mask* object is On or Off. To turn the *mask* object Off or On, press the **ON/OFF** button when the LED is illuminated.

3.5.2. Controlling the Mask Modes

When the *mask* object is selected the **MODE** button is used to control its modes, such as aspect ratio, and whether it is centred or not. Press the **MODE** button until the desired mode item is shown on the front panel, along with the current setting. To select one of the other choices for that mode item, turn one of the shaft encoders knobs. When you have chosen the desired setting for the mode item press the **MODE** button again to save the new setting and view the next mode item. Continue pressing the **MODE** key until you see the message *Mode Select Off*. The shaft encoders revert to controlling the selected *attribute* for the *mask* that is also shown on the *ctrl* line of the OSD.

3.5.2.1. Controlling the Aspect Ratio of the Mask

Aspect ratio	Off	1:1	4:3	14:9	16:9	1.67:1	1.85:1	2.35:1
--------------	-----	-----	-----	------	------	--------	--------	--------

This item is used to control whether the *mask* object shape is constrained to a specific aspect ratio, or whether its horizontal and vertical dimensions can be independently controlled.

Select **Off** to allow the *mask* object's horizontal and vertical dimensions to be independently controlled. The OSD will show the actual aspect ratio of the *mask* on the *user aspect* line.

Select one of the specific aspect ratios to constrain the horizontal and vertical dimensions of the *mask* object so that its aspect ratio is maintained. The setting of the *Mask Apert* item in the *Setup* menu control the maximum horizontal or vertical size of the *mask* when one of the specific aspect ratios is selected. The user is still able to adjust the size of the *mask* all the way out to the production aperture regardless of the *Mask Apert* setting. The OSD will show the specified aspect ratio of the *mask* on the *fixed aspect* line.

3.5.2.2. Centering the Mask on the Raster

Centre:	H + V	Off
---------	-------	-----

This item is used to control whether the *mask* object is centred on the raster or not. The *centre* item is only available when the *SETUP* menu item *force centre* is set to *off*.

Select **H + V** to force the *mask* object to be centred on the raster. The OSD will show *centred*.

Select **off** to allow the *mask* object to be moved off centre. The OSD will show *not centred*. In this *MODE* it is possible to independently position the top, bottom, left and right limits of the *mask*, or to size the whole *mask*, depending on the settings of the *aspect ratio MODE item* and what *CTRL SEL* item is chosen.

3.5.2.3. Controlling the Opacity (Transparency) of the *Mask*

Opacity:	100%	75%	50%	25%
----------	------	-----	-----	-----

This item is used to control the opacity (transparency) of the *mask* object

Select **100%** to have a solid (100% opaque) *mask*. *The mask* will completely cover the picture in the colour set by the *Colour* control.

Select **75%** to have a 75% opaque (25% transparent) *mask*. *The mask* will be keyed with a mix ratio of 75% *mask* and 25% picture.

Select **50%** to have a 50% opaque (50% transparent) *mask*. *The mask* will be keyed with a mix ratio of 50% *mask* and 50% picture.

Select **25%** to have a 25% opaque (75% transparent) *mask*. *The mask* will be keyed with a mix ratio of 25% *mask* and 75% picture.

3.5.3. Controlling the *Mask* Attributes

When the *mask* object is selected the **CTRL SEL** button is used to select which of its attributes (colour, position, size, or individual edges of the object) will be adjusted by turning the shaft encoder knobs. Press the **CTRL SEL** button until the desired *CTRL SEL* item is shown on the front panel. When you have chosen the desired *CTRL SEL* item press the **MASK** button again or turn one of the shaft encoder knobs to begin controlling the selected attribute of the *mask*. The selected attribute for control will show on the *ctrl* line of the OSD.

The items that are shown in the *mask CTRL SEL* menu depend on the *MODE* settings and the settings in the *SETUP* menu. In the sections describing the *CTRL SEL* items, the relevant settings from the *mask MODE* and *SETUP* menus are shown where necessary.

3.5.3.1. Controlling the *Mask* Colour

Colour The colour of the *mask* object can be adjusted in the range of “0” through “14”, in single digit increments, using either shaft encoder. The colours that will be displayed for each value are shown in Table 3-2.

3.5.3.2. Controlling the *Mask* Size (*Mask* Centred, Aspect Ratio Off)

Setup menu	Force centre	<i>no</i>
Mode menu	Aspect ratio	<i>off</i>
Mode menu	Centre	<i>H + V</i>

or

Setup menu	Force centre	<i>yes</i>
Mode menu	Aspect ratio	<i>off</i>

Size When the *mask* is centred and aspect ratio *MODE* is Off, the left shaft encoder is used to adjust the height and the right shaft encoder is used to adjust the width of the *mask* about the centre of the raster.

3.5.3.3. Controlling the *Mask Size (Mask Centred, Aspect Ratio On)*

Setup menu	Force centre	Yes						
Mode menu	Aspect ratio	1:1	4:3	14:9	16:9	1.67:1	1.85:1	2.35:1

Or

Setup menu	Force centre	No						
Mode menu	Aspect ratio	1:1	4:3	14:9	16:9	1.67:1	1.85:1	2.35:1
Mode menu	Centre	H + V						

Size When the *mask* is centred and aspect ratio MODE is On, the left and right shaft encoders are used to adjust the overall *size* of the *mask* proportionately about its centre while maintaining the selected *aspect ratio*. The size is adjusted about the centre of the raster.

3.5.3.4. Controlling the *Mask Size and Position (Mask not centred, Aspect Ratio Off)*

Setup menu	Force centre	no						
Mode menu	Aspect ratio	off						
Mode menu	Centre	off						

When the *mask* centering is Off and aspect ratio MODE is Off the H and V lines can be positioned independently in one of four modes.

V track The left shaft encoder is used to adjust the vertical position of the *mask*, i.e. move the *mask* up or down and the right shaft encoder is used to adjust the height of the *mask*.

V no track The left shaft encoder is used to adjust the top of the *mask* and the right shaft encoder is used to adjust the bottom of the *mask*.

H track The left shaft encoder is used to adjust the horizontal position of the *mask*, i.e. move the *mask* left or right and the right shaft encoder is used to adjust the width of the *mask*.

H no track The left shaft encoder is used to adjust the left side of the *mask* and the right shaft encoder is used to adjust the right side of the *mask*.

3.5.3.5. Controlling the *Mask Size and Position (Mask not centred, Aspect Ratio On)*

Setup menu	Force centre	No						
Mode menu	Aspect ratio	1:1	4:3	14:9	16:9	1.67:1	1.85:1	2.35:1
Mode menu	Centre	Off						

When the *mask* centering is Off and aspect ratio mode is On the position and overall *size* of the *mask* can be adjusted proportionately about the centre of the *mask* based upon the *aspect ratio* selected.

Position The left shaft encoder is used to adjust the vertical *position* of the *mask*, i.e. move the *mask* up or down and the right shaft encoder is used to adjust the horizontal *position* of the *mask*, i.e. move the *mask* left or right.

Size The left shaft encoder is used to adjust the size of the *mask* with the bottom right corner fixed. The right shaft encoder is used to adjust the size of the *mask* with the top left corner fixed. The aspect ratio of the *mask* is maintained as the size is adjusted.

3.6. CONTROLLING THE CURSOR OBJECTS

There are two *cursor* objects, called *cursor1* and *cursor2*. Each of the *cursor* objects consist of a horizontal and vertical line that intersect at their mid points. Each of the *cursor* objects can be controlled independently, and operate the same way. References throughout this section to the *cursor* object apply to either *cursor1* or *cursor2*. The lines are shaped to avoid sharp transitions in the video. Line width may be adjusted using the *Line Width* attribute. The locations of the cursor lines shown is the centre of the line.

3.6.1. Turning the *Cursor* Objects On and Off

To select the *cursor1* object press the **CURSOR** button. The *cursor1* object will blink momentarily (if the *cursor1* is On and the *obj blink* item on the Setup menu is enabled) and the LED above the **CURSOR** button will come on indicating that the *cursor1* object is selected. To select the *cursor2* object press the **CURSOR** button a second time. The *cursor2* object will blink momentarily (if the *cursor2* is On and the *obj blink* item on the Setup menu is enabled). The on screen display will be automatically turned on if the *OSD TIMER* item on the *SETUP* menu is not set to *Off* and will indicate which *cursor* object is selected and whether it is on or off. To turn either *cursor* object On or Off, press the **ON/OFF** button when the it is selected.

3.6.2. Controlling the *Cursor* Modes

When the *cursor* object is selected, the **MODE** button is used to control its modes, such as aspect ratio, and whether it is centred or not. Press the **MODE** button until the desired mode item is shown on the front panel, along with the current setting. To select one of the other choices for that mode item, turn one of the shaft encoders knobs. When you have chosen the desired setting for the mode item press the **MODE** button again to save the new setting and view the next mode item. Continue pressing the **MODE** key until you see the message *Mode Select Off*. The shaft encoders revert to controlling the selected *attribute* for the *cursor* that is also shown on the *ctrl* line of the OSD.

3.6.2.1. Centering the *Cursor* on the Raster

Centre:	H + V	Off
---------	-------	-----

This item is used to control whether the *cursor* object is centred on the raster or not. The *cursor* object centering is not affected by the *SETUP* menu item *force centre* item.

Select **yes** to force the *cursor* object to be centred on the raster. The OSD will show *centred*.

Select **off** to allow the *cursor* object to be moved off centre. The OSD will show *not centred*. In this *MODE* it is possible to independently position the *cursor*, depending on what *CTRL SEL* item is chosen.

3.6.3. Controlling the *Cursor* Attributes

When the *cursor* object is selected the **CTRL SEL** button is used to select which of its attributes (colour, line width, position, or size) will be adjusted by turning the shaft encoder knobs. Press the **CTRL SEL** button until the desired *CTRL SEL* item is shown on the front panel. When you have chosen the desired *CTRL SEL* item press the **CURSOR** button again or turn one of the shaft encoder knobs to begin controlling the selected attribute of the *cursor*. The selected attribute for control will show on the *ctrl* line of the OSD.

3.6.3.1. Controlling the *Cursor* Colour

Colour The colour of the *cursor* object can be adjusted in the range of “0” through “14”, in single digit increments, using either shaft encoder. The colours that will be displayed for each value are shown in Table 3-2.

3.6.3.2. Controlling the *Cursor* Line Width

Line Width	3	5	7	9	11
------------	---	---	---	---	----

Line Width The line width of the *cursor* object can be adjusted in the range of “3” through “11”, in increments of two, using either shaft encoder. Only the pixels (lines) in the centre of the line width are keyed at 100%. The edges of the line are keyed at a reduced level to reduce aliasing.

3.6.3.3. Controlling the *Cursor* Size

Size The size of the *cursor* can be adjusted using either of the shaft encoders. The size will change proportionately about the centre of the *cursor*.

H/V Size The left shaft encoder is used to adjust the height of the *CURSOR* vertical line, and the right shaft encoder is used to adjust the width of the *cursor* horizontal line.

3.6.3.4. Controlling the *Cursor* Position (*Cursor* not centred)

Mode menu	Centre	off
-----------	--------	-----

When the *cursor* centering is Off the position of the *cursor* can be adjusted.

Position The left shaft encoder is used to adjust the vertical *position* of the *cursor*, i.e. move the *cursor* up or down and the right shaft encoder is used to adjust the horizontal *position* of the *cursor*, i.e. move the *cursor* left or right.

3.7. CONTROLLING THE BOX OBJECTS

There are two *box* objects, called *box1* and *box2*. Each of the *box* objects can be controlled independently, and operate the same way. Often *box1* is used to mark the safe action area and *box2* is used to mark the safe title area. References throughout this section to the *box* object apply to either *box1* or *box2*. The box perimeter lines are shaped to avoid sharp transitions in the video. Line width may be adjusted using the *Line Width* attribute. The locations of the box perimeter lines shown is the centre of the line.

3.7.1. Turning the Box Objects On and Off

To select the *box1* object press the **BOX** button. The *box1* object will blink momentarily (if the *box1* is On and the *obj blink* item on the Setup menu is enabled) and the LED above the **BOX** button will come on indicating that the *box1* object is selected. To select the *box2* object press the **BOX** button a second time. The *box2* object will blink momentarily (if the *box2* is On and the *obj blink* item on the Setup menu is enabled). The on screen display will be automatically turned on if the *OSD TIMER* item on the *SETUP* menu is not set to *Off* and will indicate which *box* object is selected and whether it is on or off. To turn either *box* object On or Off, press the **ON/OFF** button when the it is selected.

3.7.2. Controlling the Box Modes

When the *box* object is selected, the **MODE** button is used to control its modes, such as aspect ratio, and whether it is centred or not. Press the **MODE** button until the desired mode item is shown on the front panel, along with the current setting. To select one of the other choices for that mode item, turn one of the shaft encoders knobs. When you have chosen the desired setting for the mode item press the **MODE** button again to save the new setting and view the next mode item. Continue pressing the **MODE** key until you see the message *Mode Select Off*. The shaft encoders revert to controlling the selected *control* for the *box* that is also shown on the *ctrl* line of the OSD.

3.7.2.1. Controlling the Aspect Ratio of the Box

Aspect ratio	Off	1:1	4:3	14:9	16:9	1.67:1	1.85:1	2.35:1
--------------	-----	-----	-----	------	------	--------	--------	--------

This item is used to control whether the *box* object shape is constrained to a specific aspect ratio, or whether its horizontal and vertical dimensions can be independently controlled.

Select **Off** to allow the *box* object's horizontal and vertical dimensions to be independently controlled. The OSD will show the actual aspect ratio of the *box* on the *user aspect* line.

Select one of the specific aspect ratios to constrain the horizontal and vertical dimensions so that the aspect ratio of the *box* object is maintained. The OSD will show the specified aspect ratio of the *box* on the *fixed aspect* line.

3.7.2.2. Choosing a Solid or Dashed Box

Disp:	solid	dashed
-------	-------	--------

This item is used to control whether the *box* object is composed of solid or dashed lines.

Select **solid** to draw the *box* object with solid lines.

Select **dashed** to draw the *box* object with broken lines.

3.7.2.3. Centering the Box on the Raster

Centre:	H + V	Off
---------	-------	-----

This item is used to control whether the *box* object is centred on the raster or not. The *centre* item is only available when the *SETUP* menu item *force centre* is set to *off*.

Select **H + V** to force the *box* object to be centred on the raster. The OSD will show *centred*.

Select **off** to allow the *box* object to be moved off centre. The OSD will show *not centred*. In this *MODE* it is possible to independently position each line on the *box*, or to position and size the whole *box*, depending on the settings of the *aspect ratio MODE item* and what *CTRL SEL* item is chosen.

3.7.3. Controlling the *Box* Attributes

When the *box* object is selected the **CTRL SEL** button is used to select which of its attributes (colour, line width, position, size, or individual sides of the *box*) will be adjusted by turning the shaft encoder knobs. Press the **CTRL SEL** button until the desired *CTRL SEL* item is shown on the front panel. When you have chosen the desired *CTRL SEL* item press the **BOX** button again or turn one of the shaft encoder knobs to begin controlling the *box*. The selected attribute for control will show on the *ctrl* line of the OSD.

The items that will be shown in the *box CTRL SEL* menu depend on the *MODE* settings and the settings in the *SETUP* menu. In the sections describing the *CTRL SEL* items, the relevant settings from the *box MODE* and *SETUP* menus are shown where necessary.

3.7.3.1. Controlling the *Box* Colour

Colour The colour of the *box* object can be adjusted in the range of “0” through “14”, in single digit increments, using either shaft encoder. The colours that will be displayed for each value are shown in Table 3-2.

3.7.3.2. Controlling the *Box* Line Width

Line Width	3	5	7	9	11
------------	---	---	---	---	----

Line Width The line width of the *box* object can be adjusted in the range of “3” through “11”, in increments of two, using either shaft encoder. Only the pixels (lines) in the centre of the line width are keyed at 100%. The edges of the line are keyed at a reduced level to reduce aliasing.

3.7.3.3. Controlling the *Box* Size (*Box* Centred, Aspect Ratio Off)

Setup menu	Force centre	<i>no</i>	or	Setup menu	Force centre	<i>yes</i>
Mode menu	Aspect ratio	<i>off</i>		Mode menu	Aspect ratio	<i>off</i>
Mode menu	Centre	<i>H + V</i>				

Size When the *box* is centred and aspect ratio *MODE* is Off, the left shaft encoder is used to adjust the height and the right shaft encoder is used to adjust the width about the centre of the raster.

3.7.3.4. Controlling the *Box* Size and Position (*Box* centred, Aspect Ratio On)

Setup menu	Force centre	Yes						
Mode menu	Aspect ratio	1:1	4:3	14:9	16:9	1.67:1	1.85:1	2.35:1

Or

Setup menu	Force centre	No						
Mode menu	Aspect ratio	1:1	4:3	14:9	16:9	1.67:1	1.85:1	2.35:1
Mode menu	Centre	H + V						

Size When the *box* is centred and aspect ratio MODE is On, the left and right shaft encoders are used to adjust the overall *size* of the *box* proportionately about the centre of the raster based upon the *aspect ratio* selected.

3.7.3.5. Controlling the *Box* Size and Position (*Box* not centred, Aspect Ratio Off)

Setup menu	Force centre	no	
Mode menu	Aspect ratio	off	
Mode menu	Centre	off	

When the *box* centering is Off and aspect ratio MODE is Off the sides of the *box* can be positioned independently in one of four modes.

Size The left shaft encoder is used to adjust the height of the *box*, and the right shaft encoder is used to adjust the width of the *box* about the centre of the *box*.

Position The left shaft encoder is used to adjust the vertical position of the *box*, i.e. move the *box* up or down, and the right shaft encoder is used to adjust the horizontal position of the *box*, i.e. move the *box* left or right.

H no track The left shaft encoder is used to adjust the left side of the *box* and the right shaft encoder is used to adjust the right side of the *box*.

V no track The left shaft encoder is used to adjust the top of the *box* and the right shaft encoder is used to adjust the bottom of the *box*.

3.7.3.6. Controlling the *Box* Size and Position (*Box* not centred, Aspect Ratio On)

Setup menu	Force centre	No						
Mode menu	Aspect ratio	1:1	4:3	14:9	16:9	1.67:1	1.85:1	2.35:1
Mode menu	Centre	off						

When the *box* centering is Off and aspect ratio mode is On the position and overall *size* of the *box* can be adjusted proportionately about the centre of the *box* based upon the *aspect ratio* selected.

Position The left shaft encoder is used to adjust the vertical *position* of the *box*, i.e. move the *box* up or down and the right shaft encoder is used to adjust the horizontal *position* of the *box*, i.e. move the *box* left or right.

Size The left shaft encoder is used to adjust the size of the *box* with the bottom right corner fixed. The right shaft encoder is used to adjust the size of the *box* with the top left corner fixed.

3.8. CONTROLLING THE ELLIPSE OBJECT

3.8.1. Turning the *Ellipse* Object On and Off

To select the *ellipse* object press the **ELLIPSE** button. A dashed line at the edge of the *ellipse* object will blink momentarily (if the *ellipse* is On and the *obj blink* item on the *Setup* menu is enabled) and the LED above the **ELLIPSE** button will come on indicating that the *ellipse* object is selected. The on screen display will be automatically turned on if the *OSD TIMER* item on the *SETUP* menu is not set to *Off* and will indicate if the *ellipse* object is On or Off. To turn the *ellipse* object Off or On, press the **ON/OFF** button when the LED is illuminated. The *ellipse* line is shaped to avoid sharp transitions in the video. Line width may be adjusted using the *Line Width* attribute. The locations of the *ellipse* boundaries shown is the centre of the line.

3.8.2. Controlling the *Ellipse* Modes

When the *ellipse* object is selected, the **MODE** button is used to control its modes, such as aspect ratio, and whether it is centred or not. Press the **MODE** button until the desired mode item is shown on the front panel, along with the current setting. To select one of the other choices for that mode item, turn one of the shaft encoders knobs. When you have chosen the desired setting for the mode item press the **MODE** button again to save the new setting and view the next mode item. Continue pressing the **MODE** key until you see the message *Mode Select Off*. The shaft encoders revert to controlling the selected *control* for the *ellipse* that is also shown on the *ctrl* line of the OSD.

3.8.2.1. Controlling the Aspect Ratio of the *Ellipse*

Aspect ratio	Off	1:1	4:3	14:9	16:9	1.67:1	1.85:1	2.35:1
--------------	-----	-----	-----	------	------	--------	--------	--------

This item is used to control whether the *ellipse* object shape is constrained to a specific aspect ratio, or whether its horizontal and vertical dimensions can be independently controlled.

Select **Off** to allow the *ellipse* object's horizontal and vertical dimensions to be independently controlled. The OSD will show the actual aspect ratio of the *ellipse* on the *user aspect* line.

Select one of the specific aspect ratios to constrain the horizontal and vertical dimensions so that the aspect ratio of the *ellipse* object is maintained. The OSD will show the specified aspect ratio of the *ellipse* on the *fixed aspect* line.

3.8.2.2. Centering the *Ellipse* on the Raster

Centre:	H + V	Off
---------	-------	-----

This item is used to control whether the *ellipse* object is centred on the raster or not. The *centre* item is only available when the *SETUP* menu item *force centre* is set to *off*.

Select **yes** to force the *ellipse* object to be centred on the raster. The OSD will show *centred*.

Select **off** to allow the *ellipse* object to be moved off centre. The OSD will show *not centred*. In this *MODE* it is possible to independently position each line on the *ellipse*, or to position and size the whole *ellipse*, depending on the settings of the *aspect ratio MODE* item and what *CTRL SEL* item is chosen.

3.8.3. Controlling the *Ellipse* Attributes

When the *ellipse* object is selected the **CTRL SEL** button is used to select which of its attributes (colour, line width, position, size, or individual axes of the *ellipse*) will be adjusted by turning the shaft encoder knobs. Press the **CTRL SEL** button until the desired *CTRL SEL* item is shown on the front panel. When you have chosen the desired *CTRL SEL* item press the **ELLIPSE** button again or turn one of the shaft encoder knobs to begin controlling the selected attribute of the *ellipse*. The selected attribute for control will show on the *ctrl* line of the OSD.

The items that will be shown in the *ellipse CTRL SEL* menu depend on the *MODE* settings and the settings in the *SETUP* menu. In the sections describing the *CTRL SEL* items, the relevant settings from the *ellipse MODE* and *SETUP* menus are shown where necessary.

3.8.3.1. Controlling the *Ellipse* Colour

Colour The colour of the *ellipse* object can be adjusted in the range of “0” through “14”, in single digit increments, using either shaft encoder. The colours that will be displayed for each value are shown in Table 3-2.

3.8.3.2. Controlling the *Ellipse* Line Width

Line Width	3	5	7	9	11
------------	---	---	---	---	----

Line Width The line width of the *ellipse* object can be adjusted in the range of “3” through “11”, in increments of two, using either shaft encoder. Only the pixels (lines) in the centre of the line width are keyed at 100%. The edges of the line are keyed at a reduced level to reduce aliasing.

3.8.3.3. Controlling the *Ellipse* Size (*Ellipse* Centred, Aspect Ratio Off)

Setup menu	Force centre	<i>no</i>	or	Setup menu	Force centre	<i>yes</i>
Mode menu	Aspect ratio	<i>off</i>		Mode menu	Aspect ratio	<i>off</i>
Mode menu	Centre	<i>H + V</i>				

Size When the *ellipse* is centred and aspect ratio *MODE* is Off, the left shaft encoder is used to adjust the height and the right shaft encoder is used to adjust the width about the centre of the raster.

3.8.3.4. Controlling the *Ellipse* Size and Position (*Ellipse* centred, Aspect Ratio On)

Setup menu	Force centre	<i>Yes</i>						
Mode menu	Aspect ratio	1:1	4:3	14:9	16:9	1.67:1	1.85:1	2.35:1

Or

Setup menu	Force centre	<i>No</i>						
Mode menu	Aspect ratio	1:1	4:3	14:9	16:9	1.67:1	1.85:1	2.35:1
Mode menu	Centre	<i>H + V</i>						

Size When the *ellipse* is centred and aspect ratio *MODE* is On, the left and right shaft encoders are used to adjust the overall *size* of the *ellipse* proportionately about the centre of the *ellipse* while maintaining the *aspect ratio* selected.

3.8.3.5. Controlling the *Ellipse* Size and Position (*Ellipse* not centred, Aspect Ratio Off)

Setup menu	Force centre	<i>no</i>
Mode menu	Aspect ratio	<i>off</i>
Mode menu	Centre	<i>off</i>

When the *ellipse* centering is Off and aspect ratio MODE is Off the position and the H and V size of the *ellipse* lines can be positioned independently.

Size The left shaft encoder is used to adjust the height of the *ellipse*, and the right shaft encoder is used to adjust the width of the *ellipse*.

Position The left shaft encoder is used to adjust the vertical position of the *ellipse*, i.e. move the *ellipse* up or down, and the right shaft encoder is used to adjust the horizontal position of the *ellipse*, i.e. move the *ellipse* left or right.

3.8.3.6. Controlling the *Ellipse* Size and Position (*Ellipse* not centred, Aspect Ratio On)

Setup menu	Force centre	<i>No</i>						
Mode menu	Aspect ratio	1:1	4:3	14:9	16:9	1.67:1	1.85:1	2.35:1
Mode menu	Centre	<i>off</i>						

When the *ellipse* centering is Off and aspect ratio mode is On the position and overall size of the *ellipse* can be adjusted proportionately about the centre of the *ellipse* based upon the *aspect ratio* selected.

Size Either of the shaft encoders can be used to adjust the size of the *ellipse* around its centre, while maintaining the selected aspect ratio for the H and V axes.

Position The left shaft encoder is used to adjust the vertical *position* of the *ellipse*, i.e. move the *ellipse* up or down and the right shaft encoder is used to adjust the horizontal *position* of the *ellipse*, i.e. move the *ellipse* left or right.

3.9. LOADING FACTORY PRESETS

The **FACT PRESET** button is used to recall the most recently used *factory preset*. Turn one of the shaft encoder knobs to cycle through the available *factory presets*. The name of the selected preset will be shown on the front panel display, and the selected collection of object settings will be loaded into to the Graticule Generator. The **PRESET ACTIVE** LED will illuminate when one of the Factory presets is loaded. The *factory presets* available at the time of printing are shown in Chapter 7. In the front panel descriptions of the *factory presets* CA refers to clean aperture and PA refers to production aperture.

3.10. WORKING WITH THE USER PRESETS

The Graticule Generator has ten memory locations to store user defined presets. Each preset contains a collection of object parameters that define what objects are on, and the **OBJECT MODES AND CTRL SEL** settings for the objects. There are ten *user preset* locations for each video standard. Each of the *user preset* locations can be write-protected, or can be left unlocked, so users can save their favourite settings. When the Graticule Generator is reset to its factory default condition, the ten *user preset* locations are filled with ten of the *factory presets*.

3.10.1. Saving User Presets

To save the current object settings into one of the ten *user preset* memory locations, press the **PRESET SAVE** button. The Front panel display will show *Store Preset #*. Then press the **USER PRESET** button corresponding to the location you wish to store the settings to. The Front panel display will show *SAVE to store n* where *n* is the number of the *user preset*. Press the **PRESET SAVE** button a second time to confirm the operation (The Front panel display will show *Preset n stored*) or press the **ESC** button to abort the store operation. If the user attempts to store a preset into a write protected location the front panel will display the message *Preset n locked*.



User Presets cannot be deleted directly from memory they can only be overwritten by another configuration saved to the same memory location.

3.10.2. Recalling User Presets

To load the current object settings from one of the ten *user preset* memory locations; press *the* **USER PRESET** button corresponding to the location you wish to restore the settings from.



Recalling one of the user presets will overwrite the current object settings and can not be undone. Make sure you want to overwrite your current settings before you recall one of the user presets



User presets cannot be recalled if the keyer is off.

3.10.3. Customizing the User Preset Names

The User presets can be uploaded to a computer text file using the Ethernet port. You can edit this text file giving each of the presets a more 'user friendly' name, and then download the file back to the Graticule generator. The names that you have assigned will be shown on the front panel when you recall the user presets using the procedure in section 3.10.2. You can also download this user preset file to multiple Graticule generators to pre configure them with your customized preset settings. See section 5.4 for information on uploading and downloading user presets.

This page left intentionally blank

CHAPTER 4: HOW TO OPERATE THE GRATICULE GENERATOR USING THE DESKTOP REMOTE CONTROL PANEL

TABLE OF CONTENTS

4. HOW TO OPERATE THE GRATICULE GENERATOR USING THE DESKTOP REMOTE CONTROL PANEL	4-1
4.1. AN OVERVIEW OF THE KEY AND DISPLAY FUNCTIONS.....	4-1
4.1.1. The Object Push-button Group.....	4-2
4.1.2. The Setup Button Group.....	4-2
4.1.3. The Preset Group.....	4-3
4.1.4. Shaft Encoders (Knobs)	4-3
4.1.5. Status Indicators.....	4-4
4.1.6. Front Panel Display Messages	4-4
4.2. SETUP MENU	4-4
4.2.1. Choosing the Raster limits for the Mask Aspect Ratio and Size Calculation	4-5
4.2.2. Choosing the Raster limits for the Box Size Calculation	4-6
4.2.3. Choosing the Object Blink Time	4-6
4.2.4. Choosing How Line Numbers are Displayed	4-6
4.2.5. Displaying Object Aspect Ratio or Position on the Front Panel.....	4-7
4.2.6. Forcing all Objects to be Centered on the Raster	4-7
4.2.7. Setting how long the On Screen Display will be Active	4-7
4.2.8. Selecting the On Screen Display Position.....	4-8
4.2.9. Selecting the SMPTE Safe Area Specification.....	4-8
4.2.10. Operating the HD9690 in Auto Video Standard Mode.....	4-8
4.2.11. Selecting the Video Type (Model HD9690-444 only)	4-8
4.2.12. Selecting the 4:4:4 Colour Space (Model HD9690-444 only)	4-9
4.3. CONTROLLING THE INDIVIDUAL OBJECTS.....	4-10
4.3.1. Controlling the Object Aspect Ratios	4-10
4.3.2. Controlling the Object Size	4-11
4.3.3. Controlling the Object Position	4-11
4.3.4. Controlling the Object Colour.....	4-12
4.3.5. Remote Panel Display when Controlling the Objects.....	4-12
4.3.6. On Screen Display when Controlling the Objects	4-12
4.4. CONTROLLING THE GRID OBJECT	4-13
4.4.1. Turning the <i>Grid</i> Object On and Off	4-13
4.4.2. Centering the <i>Grid</i> on the Raster	4-13
4.4.2.1. Controlling the <i>Grid</i> Colour.....	4-13
4.4.3. Controlling the <i>Grid</i> Size.....	4-13
4.4.3.1. Controlling the <i>Grid</i> Size (<i>Objects</i> centred or Aspect Ratio mode On).....	4-13
4.4.3.2. Controlling the <i>Grid</i> Size and Position (<i>Objects</i> not centred, Aspect Ratio Off) ...	4-14
4.5. CONTROLLING THE MASK OBJECT	4-14
4.5.1. Turning the Mask Object On and Off	4-15
4.5.2. Controlling the Aspect Ratio of the <i>Mask</i>	4-15
4.5.2.1. Centering the Mask on the Raster.....	4-15
4.5.2.2. Controlling the <i>Mask</i> Colour	4-15
4.5.3. Controlling the <i>Mask</i> Size	4-15
4.5.3.1. Controlling the <i>Mask</i> Size (<i>Objects</i> centred, Aspect Ratio Off).....	4-16
4.5.3.2. Controlling the <i>Mask</i> Size (Aspect Ratio On)	4-16

4.5.3.3. Controlling the <i>Mask</i> Size and Position (<i>Objects</i> not centred, Aspect Ratio Off) ..	4-16
4.5.4. Controlling the <i>Mask</i> Position	4-16
4.6. CONTROLLING THE CURSOR OBJECT	4-16
4.6.1. Turning the <i>Cursor</i> Object On and Off	4-17
4.6.2. Centering the <i>Cursor</i> on the Raster	4-17
4.6.2.1. Controlling the <i>Cursor</i> Colour	4-17
4.6.2.2. Controlling the <i>Cursor</i> Size	4-17
4.6.2.3. Controlling the <i>Cursor</i> Position (<i>Objects</i> not centred, Aspect Ratio Off)	4-17
4.7. CONTROLLING THE BOX OBJECTS	4-17
4.7.1. Turning the <i>Box</i> Objects On and Off	4-18
4.7.2. Controlling the Aspect Ratio of the <i>Box</i>	4-18
4.7.3. Centering the <i>Box</i> on the Raster	4-18
4.7.3.1. Controlling the <i>Box</i> Colour	4-18
4.7.4. Controlling the <i>Box</i> Size	4-19
4.7.4.1. Controlling the <i>Box</i> Size (<i>Objects</i> centred, Aspect Ratio Off)	4-19
4.7.4.2. Controlling the <i>Box</i> Size (Aspect Ratio On)	4-19
4.7.4.3. Controlling the <i>Box</i> Size and Position (<i>Objects</i> not centred, Aspect Ratio Off) ...	4-19
4.7.5. Controlling the <i>Box</i> Position	4-19
4.8. CONTROLLING THE ELLIPSE OBJECT	4-20
4.8.1. Turning the <i>Ellipse</i> Object On and Off	4-20
4.8.2. Controlling the Aspect Ratio of the <i>Ellipse</i>	4-20
4.8.2.1. Centering the <i>Ellipse</i> on the Raster	4-20
4.8.2.2. Controlling the <i>Ellipse</i> Colour	4-20
4.8.3. Controlling the <i>Ellipse</i> Size	4-20
4.8.3.1. Controlling the <i>Ellipse</i> Size (<i>Objects</i> centred, Aspect Ratio Off)	4-21
4.8.3.2. Controlling the <i>Ellipse</i> Size (Aspect Ratio On)	4-21
4.8.3.3. Controlling the <i>Ellipse</i> Size and Position (<i>Objects</i> not centred, Aspect Ratio Off)	4-21
4.8.4. Controlling the <i>Ellipse</i> Position	4-21
4.9. LOADING FACTORY PRESETS	4-21
4.10. WORKING WITH THE USER PRESETS	4-22
4.10.1. Saving User Presets	4-22
4.10.2. Recalling User Presets	4-22
4.10.3. Customizing the User Preset Names	4-22

Figures

Figure 4-1: Desktop Remote Panel Layout	4-1
Figure 4-2: Overview of the HD9690 Setup Menu	4-5
Figure 4-3: Overview of the HD9690-444 Setup Menu	4-5
Figure 4-4: Mask Position and Size	4-14

Tables

Table 4-1: 4:4:4 Colour Mode Processing	4-9
Table 4-2: Object Colour Palettes	4-10

4. HOW TO OPERATE THE GRATICULE GENERATOR USING THE DESKTOP REMOTE CONTROL PANEL

The standard Graticule Generator version consists of a 1 RU chassis with integrated control panel. The Graticule Generator is also available in a remote control version, which has a blank front panel and either a rack mountable, or a desktop remote control panel. Operation of the Graticule Generator from the desktop remote panel is described in this chapter. For information on controlling the Graticule Generator from the integrated control panel or the rack mount control panel see chapter 3. For information about connecting the desktop remote panel to the Graticule Generator electronics see section 2.7.

4.1. AN OVERVIEW OF THE KEY AND DISPLAY FUNCTIONS

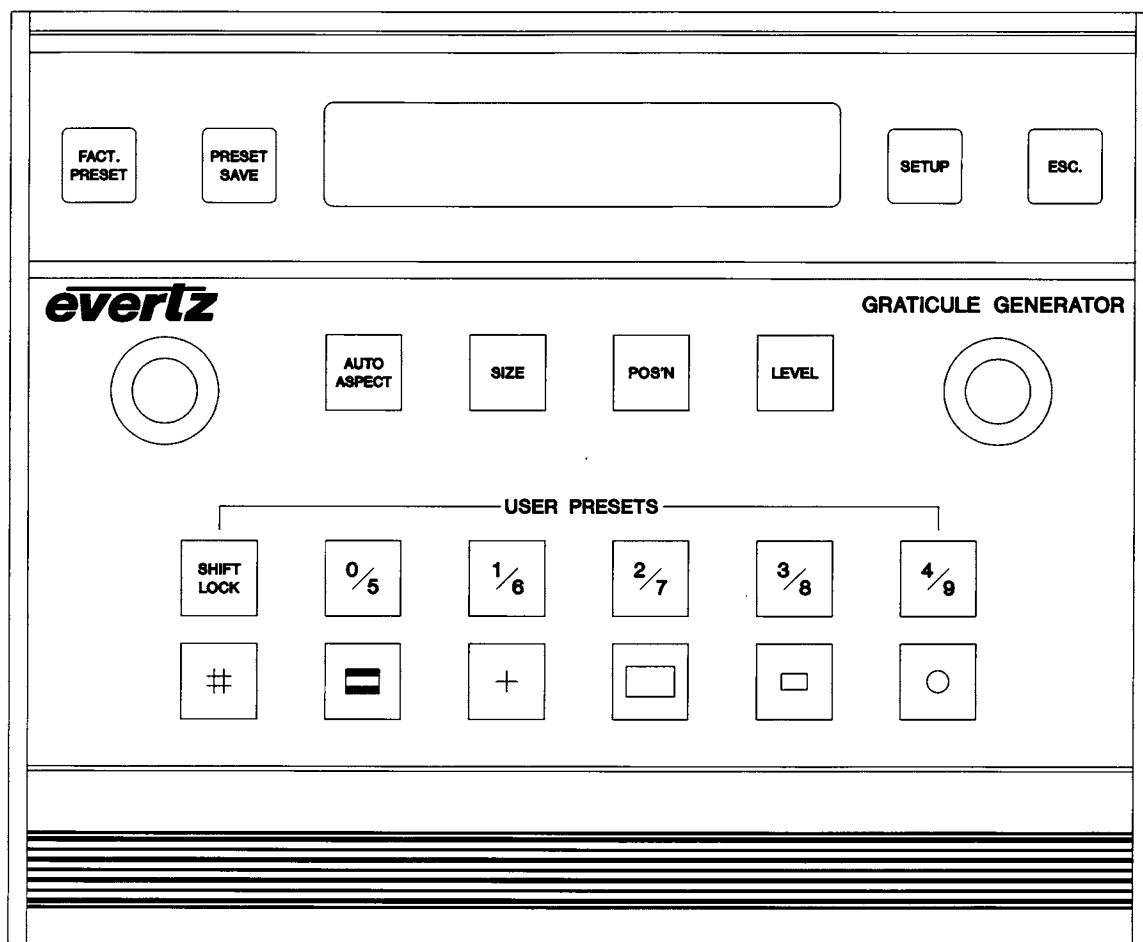

Figure 4-1: Desktop Remote Panel Layout







The desktop remote control panel contains a 16 digit alphanumeric display, and a 20 pushbutton keypad.

The keypad is used to select and control the attributes, position and size of each of the Graticule Generator objects. Each of the keys is backlit and will be illuminated so that they are easily visible in a darkened control room. When the button is active, it will be illuminated brightly, or it may blink between dim and bright illumination. The Setup menu provides a means of setting overall constraints on the Graticule Generator, allowing you to configure the device to your application. Six user preset buttons and one factory preset button allow you to save and recall frequently used collections of objects, to simplify operation of the Graticule Generator.

The remainder of this section gives an overview of each of the front panel buttons. Sections 4.3 to 4.8 give detailed information on controlling each of the screen objects.

4.1.1. The Object Push-button Group

The Object key group consists of the six object keys. The object key group is used to select individual objects and turn them on or off. Then one of the object buttons is pressed it turns on the respective object and selects it for control. The button will blink when the object is selected. To turn off the object, press the button a second time while it is blinking. The selected object will be automatically de-selected after two minutes of inactivity on the front panel. Individual objects will also be deselected when another object is selected. Objects that are turned On but not selected will have their corresponding button brightly illuminated.

- GRID**  Pressing this button selects the *grid object*.
- MASK**  Pressing this button selects the *mask object*
- CURSOR**  Pressing the button selects the first *cursor object*. The second *cursor object* is not available from the DCP.
- BOX1**  Pressing the button once selects the first *box object*.
- BOX2**  Pressing the button once selects the second *box object*
- ELLIPSE**  Pressing this button selects the *ellipse object*

AUTO ASPECT This button controls whether the Graticule Generator operates in one of the fixed aspect ratios or whether the objects can be independently sized and positioned. See section 4.3.1 for more information about *auto aspect ratio* mode.

4.1.2. The Setup Button Group

This button group consists of two buttons located adjacent to the display. The actions of this button group affect all objects.

- SETUP** Pressing this button allows you to program various global attributes for the objects, and to configure the overall operating modes for the Graticule Generator. See section 4.1.6 for a complete description of the setup modes.
- ESC** This button is used to exit out of menus or to abort setup operations.

4.1.3. The Preset Group

This button group consists of the **FACT PRESET**, **PRESET SAVE** and **SHIFT LOCK** buttons and the adjacent five numbered buttons. The actions of this button group allow you to save and recall various setups for the Graticule Generator.

FACT PRESET This button is used to recall the *factory presets*. Press this button to recall the *factory presets* that was previously selected. Turn one of the shaft encoder knobs to cycle through the available *factory presets*. The name of the selected preset will be shown on the front panel display, and the selected collection of object settings will be loaded into to the Graticule Generator. The *PRESET ACTIVE* LED will illuminate when one of the *factory presets* is loaded. See section 3.9 for a description of each of the factory presets.



Factory presets cannot be recalled if the keyer is off.

PRESET SAVE This button allows the user to save the current *object* settings to one of the ten *user preset* memory locations. To save the current object settings to one of the *user preset* locations press the **PRESET SAVE** button once, then the desired the **USER PRESET** button. You will be prompted to press the **USER PRESET** button a second time to confirm the operation. Each of the *user preset* memory locations can be individually write-protected. See section 3.10 for a complete description of how to use the *user presets*.



User presets cannot be deleted directly from memory they can only be overwritten by another configuration saved to the same memory location.

SHIFT LOCK The state of the **SHIFT LOCK** button determines whether *user preset* locations 0 to 4 or 5 to 9 will be selected with the **USER PRESET** buttons. Press the **SHIFT LOCK** button to toggle the *shift lock* function on or off. *Shift lock* is *On* when the **SHIFT LOCK** button is brightly illuminated. See section 3.9 for a complete description of how to use the *user presets*.

USER PRESETS These five buttons used in conjunction with the **SHIFT LOCK** button are used to store or recall the non-volatile *USER PRESETS*. To recall a *USER PRESET* press the corresponding button once. See section 3.9 for a complete description of how to use the *user presets*.



User presets cannot be recalled if the keyer is off.

4.1.4. Shaft Encoders (Knobs)

The shaft encoders' function is to change the value of one or more of the current object's parameters based on the current control option. When the mode or setup menus are enabled the shaft encoders are used to select menu options. The shaft encoders are also used to select the various *factory presets*.

When objects are being moved/resized on screen, the left knob controls horizontal movements, and the right knob controls vertical movements.

Horizontal move operations will be to the right for clockwise changes and to the left for counter-clockwise changes. Vertical move operations will be down for clockwise changes and up for counter-clockwise changes.

4.1.5. Status Indicators

Most of the push buttons may be illuminated brightly to show operational status of the Graticule Generator at a glance. When the Object buttons are blinking, it indicates that the object is selected for control. When the object buttons are illuminated brightly that means that the corresponding object is turned On.

4.1.6. Front Panel Display Messages

In addition to the normal operating mode displays that show the names of the inputs that have been selected, the HD9690 cycles various diagnostic messages on the front panel display when there is no active object.

HD9690-444	Product Name
Version 1.00 b 1	Firmware version
Video = 1080I	Various messages indicating the video format detected
Video = Unknown	Indicates there is no video connected, or the video format is not supported by the Graticule generator

4.2. SETUP MENU

The key to the operational flexibility of the Graticule Generator lies in the *SETUP* menu system. The *SETUP* menu system uses the 16 digit alphanumeric display and provides a quick, intuitive method of configuring the Graticule Generator, guiding you to the correct setup for your application. The *SETUP* Menu contains items that pertain to the overall operation of the Graticule Generator. In addition each object is controlled by its own *ASPECT*, *SIZE* and *POS* settings. See sections 0 to 4.8 for information on controlling each of the objects through their *MODE* and *CTRL SEL* menus.

The two keys in the Setup key group (**SETUP**, **ESC**) are used to cycle through the various items on the *SETUP* menu. The *SETUP* menu consists of a main menu with two or more choices for each menu item.

Safe Area =	2046	RP218			
-------------	------	-------	--	--	--

Figure 4-2 and Figure 4-3 give an overview of the *SETUP* menu for the HD9690 and HD9690-444 versions respectively. The menu items are shown on the left with grey shading and the various choices are shown on the right with no background shading.

Mask apert =	prod	clean					
Box % apert=	prod	clean					
Obj blink =	short	long	none				
Ln disp =	int rel	int abs					
Feedback =	aspect	pos					
Force centre	yes	no					
OSD Timer =	Off	2 secs	5 secs	10 secs	30 secs	1 min	On
OSD Posn =	Top l	Top r	Bot l	Bot r	center		
Safe Area =	2046	RP218					

Figure 4-2: Overview of the HD9690 Setup Menu

Mask apert =	prod	clean					
Box % apert=	prod	clean					
Obj blink =	short	long	none				
Ln disp =	int rel	int abs					
Feedback =	aspect	pos					
Force centre	yes	no					
OSD Timer =	off	2 secs	5 secs	10 secs	30 secs	1 min	On
OSD Posn =	top l	top r	bot l	bot r	center		
Safe Area =	2046	RP218					
Vid Type =	Auto	444 HD	422 HD				
444 Mode =	ycbcr	rgb	fsfull	fsnorm			

Figure 4-3: Overview of the HD9690-444 Setup Menu

To enter the front panel programming menu, press the **SETUP** key. Pressing the **SETUP** key again allows you to move vertically down the *Setup* menu tree. You can also use the left shaft encoder knob to move vertically up and down the *Setup* menu tree. The menu item is shown on the left of the front panel display and the current value for that menu item is shown on the right. Turn the right shaft encoder knob to reveal the choices for the current menu item. When you have selected the desired sub menu choice press the **SETUP** key to save your choice and advance to the next menu item.



The menu choice that is shown for an item when you press the **SETUP** key or turn the left shaft encoder knob will be saved as the new value for that menu item. If you do not wish to save a new value press the **ESC** key to exit the **SETUP** menu.

When you have made all the desired changes, press the **ESC** key to return to the normal display mode. After a 30-second timeout, the Graticule Generator exits from the *SETUP* menu automatically.

Each of the menu items is described in the sections below, with an explanation of what each choice does.



When you make a change to one of the **SETUP** parameters you will need to press the **SETUP** button or turn the left shaft encoder knob to save the change.

4.2.1. Choosing the Raster limits for the Mask Aspect Ratio and Size Calculation

Mask apert =	prod	clean
--------------	------	-------

This menu item sets how the aspect ratio and size calculations for the *mask* and *grid* objects are calculated. In either setting, the *mask* and *grid* objects can be positioned all the way out to the *production aperture*. When you choose one of the automatic aspect ratios for the *mask* object, its initial size and position will be calculated with respect to the mask aperture setting.

Select **prod** when you want to use the *production aperture* as the reference for the *mask* and *grid* object aspect ratio and size.

Select **clean** when you want to use the *clean aperture* as the reference for the *mask* and *grid* object aspect ratio and size.

4.2.2. Choosing the Raster limits for the Box Size Calculation

Box apert =	prod	clean
-------------	------	-------

This menu item sets how the size percentage calculations for the *box* object are calculated. In either setting, the *box* object perimeter can be positioned all the way out to the *production aperture*.

Select **prod** when you want to use the *production aperture* as the reference for the *box* object size calculation.

Select **clean** when you want to use the *clean aperture* as the reference for the *box* object size calculation.

4.2.3. Choosing the Object Blink Time

Obj blink =	short	long	none
-------------	-------	------	------

This menu item sets how long objects blink when they are selected.

Select **long** when you want a selected object to blink for twenty seconds before it reverts back to being displayed continuously.

Select **short** when you want a selected object to blink for three seconds before it reverts back to being displayed continuously.

Select **none** when you want to disable object blinking.

4.2.4. Choosing How Line Numbers are Displayed

Ln disp =	int rel	int abs
-----------	---------	---------

When the selected video standard uses an interlaced raster, this menu item changes the format that the front panel display uses to show line numbers.

Select **int rel** to view line numbers in an *interlaced relative* format. In this format lines are numbered relative to the beginning of each *field* and shown with their field number. (E.g. in 1080 line video, line 21F1 is the first line of active video in field 1; line 21F2 is the first line of active video in field 2)

Select **int abs** to view line numbers in an *interlaced absolute* format. In this format lines are numbered in an interlaced raster with the line numbers relative to the beginning of the complete frame. (E.g. in 1080 line video, line 21 is the first line of active video in field 1, line 584 is the first line of active video in field 2)

When the video standard uses a progressive (non-interlaced) raster, this menu item is not available. Line numbering is always done in a progressive system referenced to the beginning of the frame.

4.2.5. Displaying Object Aspect Ratio or Position on the Front Panel

Feedback =	aspect	pos
------------	--------	-----

This menu item sets whether the front panel display will show the object aspect ratio or position when an object's size or position is being controlled. The on screen display will show both the aspect ratio, and the object size in pixels and lines as percentage of its aperture.

Select **aspect** when you want to show the object size as a percentage of its aperture.

Select **pos** when you want to show the object position as horizontal and vertical position values.

4.2.6. Forcing all Objects to be Centered on the Raster

Force centre	yes	no
--------------	-----	----

This menu item sets whether the *grid, mask, box, ellipse* and *cursor* objects are all always centred on the screen, or whether object centering is controlled by the *auto aspect ratio* mode.

Select **yes** to force the *grid, mask, box* and *ellipse* objects to be centred on the raster. The OSD will show *all objects centred*.

Select **no** to use the *auto aspect ratio* mode to control whether the objects are centred on the raster. The OSD will show the setting of the individual object's centre mode. See section 4.3.1 for more information about centering objects with the *auto aspect ratio* mode.

4.2.7. Setting how long the On Screen Display will be Active

OSD Timer =	Off	2 secs	5 secs	10 secs	30 secs	1 min	On
-------------	-----	--------	--------	---------	---------	-------	----

This menu item allows the user to control how long the on-screen display of the object attributes will be displayed. The on-screen display will turn off after the amount of time set by this menu item with no front panel activity. To turn off the on-screen display completely select **off**. To turn on the on-screen display all the time select **on**. The on screen aspect ratio display shows the position, aspect ratio and other attributes of the selected object.



The displayed aspect ratio may be slightly different than the target aspect ratio (selected by the object's aspect ratio mode) due to rounding of the dimensions to the closest line or pixel.

4.2.8. Selecting the On Screen Display Position

OSD Posn =	Top l	Top r	Bot l	Bot r	center
------------	-------	-------	-------	-------	--------

This menu item allows the user to set the area on the screen where the on-screen display will be shown. Turn the right shaft encoder to move the display to one of 5 positions on the screen.

4.2.9. Selecting the SMPTE Safe Area Specification

Safe Area =	2046	RP218			
-------------	------	-------	--	--	--

SMPTE has recently published a new safe area specification in SMPTE ST 2046-1 based on fixed pixel matrix displays and are significantly larger than previously specified in RP218. The safe areas specified in RP218 are a legacy of past practice and are based on the limitations of CRT-based displays. This menu item allows the user to set whether the SMPTE ST 2046 or RP218 safe area specifications will be used for the factory presets

4.2.10. Operating the HD9690 in Auto Video Standard Mode

The HD9690 operates in an auto video standard mode and will attempt to detect the video standard of the incoming video and change the current video standard to match. When the incoming video does not match the current standard, the Graticule Generator will switch to the new video standard after approximately 5 seconds. This delay prevents random standards switches that otherwise may occur between some of the video formats. The new video standard will be displayed on the front panel. Video standards changes will not occur while the Graticule Generator is in the *Setup* mode, or while the on screen objects are being moved using the shaft encoder knobs.

Most of the supported standards can be detected, but there are some exceptions.

- The standards 1080I and 1080PSF are the same as far as the Graticule Generator is concerned. When the video input is in either of these standards the Graticule generator will display the standard as 1080I

4.2.11. Selecting the Video Type (Model HD9690-444 only)

Vid Type=	Auto	444 HD	422 HD
-----------	------	--------	--------

This menu item selects the video type in use.

Select **AUTO** when you want the HD9690-444 to automatically detect the video type (444 HDSDI or 422 HDSDI) from the incoming video. The HD9690-444 will attempt to detect whether the incoming video is single link 4:2:2 or dual link 4:4:4 and change its internal colour space processing to match. When both Link A and Link B input BNCs have incoming video in the same standard the HD9690-444 will assume that the input video type is 4:4:4 dual link video conforming to the SMPTE ST 372 standard and the front panel 444 LED will be ON. The *444 Mode* menu item must be set to match the colour space of the incoming video. (See section 4.2.12) When only the Link A input BNC has incoming video, the HD9690-444 will assume that the input video type is 4:2:2 YCbCr conforming to the SMPTE ST 292-1 standard. The *444 Mode* menu item is ignored in this mode and the graticule generator will be configured for YCbCr colour processing.

Select **444HD** when you want the HD9690-444 to always operate with 4:4:4 HDSDI incoming video. You must connect a valid 4:4:4 video signal to the Link A and Link B input BNC connectors. The *444 Mode* menu item must be set to match the colour space of the incoming video.

Select **422HD** when you want the HD9690-444 to always operate with 4:2:2 HDSDI incoming video. You must connect a valid 4:2:2 video signal to the Link A BNC connectors. (Any signal connected to the Link B BNC is ignored) The *444 Mode* menu item is ignored in this mode and the graticule generator will be configured for YCbCr colour processing.

4.2.12. Selecting the 4:4:4 Colour Space (Model HD9690-444 only)

444 Mode	ycbcr	rgb	fsfull	fsnorm
----------	-------	-----	--------	--------

This menu item selects the colour processing that will be applied on the incoming video. It should be set to match the colour space of incoming 4:4:4 video. This menu item is not visible with 4:2:2 input video formats. See Table 3-1 for details of the four colour processing modes and Table 3-2 for the colour palette information.

Select **ycbcr** when the incoming video is in the 10 bit 4:4:4 YCbCr format. In the *ycbcr* mode, the RGB to YCrCb colour transformation for the 4:2:2 MON output will be disabled, the YCrCb to RGB colour transformation for the DVI output will be enabled and graticule objects will have normal colour values.

Select **rgb** when the incoming video is in the 10 bit 4:4:4 RGB format compliant with SMPTE 274M or SMPTE 296M and the 4:2:2 output is to be in the normal 10 bit YCbCr format. Both the RGB and YCrCb video has the three components scaled such that the extreme values are code words 040_h (64) and 3AC_h (940) in a 10-bit representation. In the *rgb* mode, the RGB to YCrCb colour transformation for the 4:2:2 MON output will be enabled, the YCrCb to RGB colour transformation for the DVI output will be disabled and graticule objects will have normal colour values.

Select **fsfull** when the incoming video is in the extended range 10 bit 4:4:4 FSRGB format and the 4:2:2 output is to be in the FSYCbCr format. Both the FSRGB and FSYCbCr video has the three components scaled such that the extreme values are code words 04_h (4) and 3FB_h (1019) in a 10-bit representation. In the *fsfs* mode, the FSRGB to FSYCrCb colour transformation for the 4:2:2 MON output will be enabled, the YCrCb to RGB colour transformation for the DVI output will be disabled and graticule objects will have full scale colour values.

Select **fsnorm** when the incoming video is in the extended range 10 bit 4:4:4 FSRGB format and the 4:2:2 output is to be in the normal YCbCr format. The FSRGB video has its three components scaled such that the extreme values are code words 04_h (4) and 3FB_h (1019) in a 10-bit representation. The YCrCb video has the three components scaled such that the extreme values are code words 040_h (64) and 3AC_h (940) in a 10-bit representation. In the *fsrgb* mode, the FSRGB to YCrCb colour transformation for the 4:2:2 MON output will be enabled, the FSRGB to RGB colour transformation for the DVI output will be enabled and graticule objects will have full scale colour values.

444 Mode	4:4:4 In/Out		4:2:2 Mon Out		DVI Out		Colour Palette
	Min	Max	Min	Max	Min	Max	
<i>ycrcb</i>	040 _h (64)	3AC _h (940)	040 _h (64)	3AC _h (940)	040 _h (64)	3AC _h (940)	Normal
<i>rgb</i>	040 _h (64)	3AC _h (940)	040 _h (64)	3AC _h (940)	040 _h (64)	3AC _h (940)	Normal
<i>fsfull</i>	04 _h (4)	3FB _h (1019)	04 _h (4)	3FB _h (1019)	04 _h (4)	3FB _h (1019)	Full Scale
<i>fsnorm</i>	04 _h (4)	3FB _h (1019)	040 _h (64)	3AC _h (940)	04 _h (4)	3FB _h (1019)	Full Scale

Table 4-1: 4:4:4 Colour Mode Processing

Colour	Normal Palette			Full Scale Palette			
	G	B	R	G	B	R	
0	Black	040 _h (64)	040 _h (64)	040 _h (64)	04 _h (4)	04 _h (4)	04 _h (4)
1	25% Gray	11C _h (284)	11C _h (284)	11C _h (284)	100 _h (256)	100 _h (256)	100 _h (256)
2	50% Gray	1F8 _h (504)	1F8 _h (504)	1F8 _h (504)	200 _h (512)	200 _h (512)	200 _h (512)
3	75% Gray	204 _h (724)	204 _h (724)	204 _h (724)	300 _h (768)	300 _h (768)	300 _h (768)
4	White	3AC _h (940)	3AC _h (940)	3AC _h (940)	3FB _h (1019)	3FB _h (1019)	3FB _h (1019)
5	100% Green	3AC _h (940)	040 _h (64)	040 _h (64)	3FB _h (1019)	04 _h (4)	04 _h (4)
6	75% Green	204 _h (724)	040 _h (64)	040 _h (64)	300 _h (768)	04 _h (4)	04 _h (4)
7	100% Blue	040 _h (64)	3AC _h (940)	040 _h (64)	04 _h (4)	3FB _h (1019)	04 _h (4)
8	75% Blue	040 _h (64)	204 _h (724)	040 _h (64)	04 _h (4)	300 _h (768)	04 _h (4)
9	100% Red	040 _h (64)	040 _h (64)	3AC _h (940)	04 _h (4)	04 _h (4)	3FB _h (1019)
10	75% Red	040 _h (64)	040 _h (64)	204 _h (724)	04 _h (4)	04 _h (4)	300 _h (768)
11	100% Cyan	3AC _h (940)	3AC _h (940)	040 _h (64)	3FB _h (1019)	3FB _h (1019)	04 _h (4)
12	75% Cyan	204 _h (724)	204 _h (724)	040 _h (64)	300 _h (768)	300 _h (768)	04 _h (4)
13	100% Yellow	3AC _h (940)	040 _h (64)	3AC _h (940)	3FB _h (1019)	04 _h (4)	3FB _h (1019)
14	75% Yellow	204 _h (724)	040 _h (64)	204 _h (724)	300 _h (768)	04 _h (4)	300 _h (768)

Table 4-2: Object Colour Palettes

4.3. CONTROLLING THE INDIVIDUAL OBJECTS

The Graticule Generator has separate controls for each of its objects (*grid*, *mask*, *cursor*, *box1*, *box2*, and *ellipse*). To select the *object* press the corresponding button. The selected object will blink momentarily (if it is On and the *OBJ BLINK* item on the *SETUP* menu is enabled) and the object's button will blink indicating that the object is selected. To turn the object On or Off, press the object's button when it is blinking. All objects will be automatically de-selected after two minutes of inactivity on the front panel. Individual objects will also be deselected when another object is selected. The object button will be illuminated brightly when it is On but not selected. The on screen display will be automatically turned on if the *OSD TIMER* item on the *SETUP* menu is not set to *Off* and will show the object selected and whether it is on or off.

4.3.1. Controlling the Object Aspect Ratios

The **AUTO ASPECT** button is used to control the aspect ratio of the ellipse, the boxes and the mask, and whether they are centred or not. When you press the **AUTO ASPECT** button the Graticule Generator enters *auto aspect ratio select* mode and the current aspect ratio for the objects is displayed. Turn one of the shaft encoder knobs to select from a list of available aspect ratios. After a 30-second timeout, the Graticule Generator exits from the auto aspect ratio select mode. If the **ESC** button is pressed, the Graticule Generator also exits from the auto aspect ratio select mode. If the on screen display is visible it will indicate the aspect ratio of the selected object.

The auto aspect ratio mode forces the *mask* and *box* objects to be centred and their size to follow one of the following fixed aspect ratios: 1:1, 4:3(1.33), 14:9 (1.55), 1.67, 16:9 (1.78), 1.85:1, 2.35:1. (The on screen display will show the aspect ratio as *fixed aspect* and the centering as *centred*) Auto aspect ratio mode forces the *ellipse* object a 1:1 aspect ratio, and forces the *grid*, *cursor* and *ellipse* objects to be centred. When the *auto aspect ratio* mode is set to *Off* the *mask*, *box*, and *ellipse* objects' dimensions are not constrained to follow a fixed aspect ratio and the *setup menu force centre* item determines whether all the objects will be forced to the centre of the raster. (The on screen display will show the aspect ratio as *user aspect* and the centering as *not centred*)

When an object is being controlled in aspect ratio mode, the horizontal size will be adjusted first, then the aspect ratio applied to determine the correct vertical size. The pixel aspect ratio and the object aspect ratio are both used to calculate the vertical size of an object of a given horizontal size. The following formula is used to calculate the vertical size:

$$\text{Number of V lines} = \text{Number of H pixels} \times (\text{Pixel aspect ratio} / \text{Object aspect ratio})$$

This calculation will be rounded to the closest line or to the closest line pair if object centering is on.

Example: Draw a box in 1080 video standard with an aspect ratio of 4:3, with a width of 708 pixels. The Pixel aspect ratio for 1080 HD formats is 1.00.

$$\begin{aligned} \text{V lines} &= \text{H pixels} \times (\text{Pixel AR} / \text{Object AR}) \\ &= 708 \times (1 / (4/3)) \\ &= 480 \end{aligned}$$

The selected object aspect ratio defines the ideal dimensions of the object. The on screen and front panel aspect ratio displays show the actual object aspect ratio rounded to 2 decimal places. It may vary slightly from the selected object aspect ratio due to the effects of rounding to the closest line, and object centering.

The setting of the *Mask Apert* item in the *Setup* menu control the maximum horizontal or vertical size of the *mask* when one of the specific aspect ratios is selected. The user is still able to adjust the size of the *mask* all the way out to the production aperture regardless of the *Mask Apert* setting.

4.3.2. Controlling the Object Size

The **SIZE** button is used to control the size of the selected object (the one with its button blinking). The horizontal and vertical size of the object can be controlled independently using the left and right shaft encoder knobs respectively, if *auto aspect ratio* mode is Off. If one of the *auto aspect ratios* is selected, then either of the shaft encoder knobs will adjust the size of the abject about the centre of the raster while constraining its dimensions to the selected aspect ratio. See the specific section for each object for specifics about controlling the size of specific objects in each mode. The *size adjust* function will be deselected after 3 minutes of panel activity, or when another button is pressed. The on screen display will show the object size in pixels and lines, and as a percentage of its reference aperture.

4.3.3. Controlling the Object Position

Press the **POS** button to control the position of the selected object (the one with its button blinking) when *auto aspect ratio* mode is Off and the *Setup menu Force Centre* item is set to *no*. The horizontal and vertical position of the object can be controlled independently using the left and right shaft encoder knobs respectively. If one of the *auto aspect ratios* is selected or the *Setup menu Force Centre* item is set to *yes*, then the position of the *mask*, *box*, and *ellipse* objects is fixed to the centre of the clean aperture. The position of the cursor is not affected by the *Setup menu Force Centre* item or *auto aspect ratio mode*. See the specific section for each object for specifics about controlling the size of specific objects in each mode. The *position adjust* function will be deselected after 3 minutes of panel activity, or when another button is pressed. The on screen display will show the object position.

4.3.4. Controlling the Object Colour

Press the **COLOUR** button to control the colour level of the selected object (the one with its button blinking). The colour can be adjusted in the range of “0” through “14”, in single digit increments, using either shaft encoder. The colours that will be displayed for each value are shown in Table 4-2. The *colour adjust* function will be deselected after 3 minutes of panel activity, or when another button is pressed.

4.3.5. Remote Panel Display when Controlling the Objects

When an object is selected the name of the selected object will appear on the display. After a 3-second timeout, the display will show the current value of the object parameters being controlled by the knobs (as determined by the *CTRL SEL* menu).

When the object is turned off by pressing its button again while it is blinking, the display will show that the object is turned off. If the object is subsequently turned on, the display will indicate that it is on, and then will show the object parameters after a 3-second timeout.

When object attributes are being modified by turning one of the shaft encoders, the attribute being controlled is displayed along with its current value.

4.3.6. On Screen Display when Controlling the Objects

When an object is selected the name and attributes of the selected object will appear on an on screen display (OSD). (Unless the *OSD TIMER* menu item on the *Setup* menus is set to *Off*). The OSD can be located in one of 5 positions on the screen and shows the following attributes for the object:

Object name	(off on)		
Ctrl	Active Control name		
Centred	Object centering		
User aspect	Aspect ratio		
Aperture	Aperture applicable to object		
Width	Width in pixels (% of aperture width)		
Height	Height in lines (% of aperture height)		
Top	Object Top (raster line)	Btm	Object Bottom (line)
Left	Object left (pixel number)	Right	Object right(pixel)
Centre pos	Object centre position (line, pixel)		

When the object is turned off by pressing the **ON/OFF** key, the OSD will show that the object is turned off. When object attributes are being modified by turning one of the shaft encoders, the attribute being controlled is shown as the *active control name*.

4.4. CONTROLLING THE GRID OBJECT

The *grid* object consists of two horizontal lines and two vertical lines that intersect the horizontal lines. The lines are shaped to avoid sharp transitions in the video. Line width may be adjusted using the *Line Width* attribute. The locations of the grid lines shown is the centre of the line.

4.4.1. Turning the *Grid* Object On and Off

To select the *grid* object press the **GRID** button. The *grid* object will blink momentarily (if the *grid* is On and the *obj blink* item on the *setup* menu is enabled) and the **GRID** button will blink indicating that the object is selected. The on screen display will be automatically turned on if the *OSD TIMER* item on the *SETUP* menu is not set to *Off* and will indicate if the *grid* object is On or Off. To turn the *grid* On or Off, press the **GRID** button when it is blinking. The *grid* object will be automatically de-selected after two minutes of inactivity on the front panel or when another object is selected. The **GRID** button will be illuminated brightly when it is On but not selected.

4.4.2. Centering the *Grid* on the Raster

When *auto aspect ratio mode* is On the *grid* object will always be centred on the raster. (The OSD will show *centred*.) When *auto aspect ratio mode* is Off the *SETUP* menu item *force centre* controls whether the *grid* will be centred or not (see section 4.2.6 for more information about *auto aspect ratio mode*). When the *force centre* item is Off it is possible to independently position and size the *grid*, using the **SIZE** and **POS** buttons and turning one of the shaft encoders as outlined in the following sections. (The OSD will show *not centred*.)

4.4.2.1. Controlling the *Grid* Colour

Press the **COLOUR** button to adjust the *grid* colour. The colour of the *grid* object can be adjusted in the range of "0" through "14", in single digit increments, using either shaft encoder. The colours that will be displayed for each value are shown in Table 4-2.

4.4.3. Controlling the *Grid* Size

Press the **SIZE** button, when the *grid* button is blinking, to adjust the *grid* size. The size of the *grid* can be adjusted in one of two modes, depending on the setting of the *Setup menu Force Centre* item and the *Auto aspect ratio mode*. The remote panel display will show the *grid* size while the **SIZE** button is brightly illuminated. The On screen display will show the *grid* size as pixels and lines and as a percentage of its reference aperture. The *size adjust* function will be deselected after 3 minutes of panel activity, or when another button is pressed.

4.4.3.1. Controlling the *Grid* Size (*Objects centred or Aspect Ratio mode On*)

Setup menu	Force centre	Yes
------------	--------------	-----

Or

Auto Aspect ratio	1:1	4:3	14:9	16:9	1.67	1.85	2.35
-------------------	-----	-----	------	------	------	------	------

When *Force Centre* is On or *auto aspect ratio mode* is On, the left shaft encoder is used to adjust the height and the right shaft encoder is used to adjust the width about the centre of the raster when the **SIZE** button is selected.

4.4.3.2. Controlling the Grid Size and Position
(Objects not centred, Aspect Ratio Off)

Setup menu	Force centre	<i>no</i>
Auto Aspect ratio		<i>off</i>

When *Force Centre* is Off and, and *auto aspect ratio* mode is Off the left shaft encoder is used to adjust the top of the *grid* and the right shaft encoder is used to adjust the bottom of the *grid* when the **POS** button is selected. The left shaft encoder is used to adjust the left side of the *grid* and the right shaft encoder is used to adjust the right side of the *grid* when the **SIZE** button is selected.

4.5. CONTROLLING THE MASK OBJECT

The *mask* object consists of a horizontal masked area at the top and bottom of the raster, and a vertical masked area at the left and right side of the raster. Throughout the remainder of section 4.5.2.2 the *mask* dimensions refer to the boundaries between the masked and unmasked area as shown in Figure 4-4. The left side of the mask is the first unmasked pixel; the right side is the last unmasked pixel. The top of the mask is the first unmasked line and the bottom of the mask is the last unmasked line. The horizontal transitions from mask to image are shaped as shown in Figure 4-4. The vertical transitions from mask to image are hard transitions.

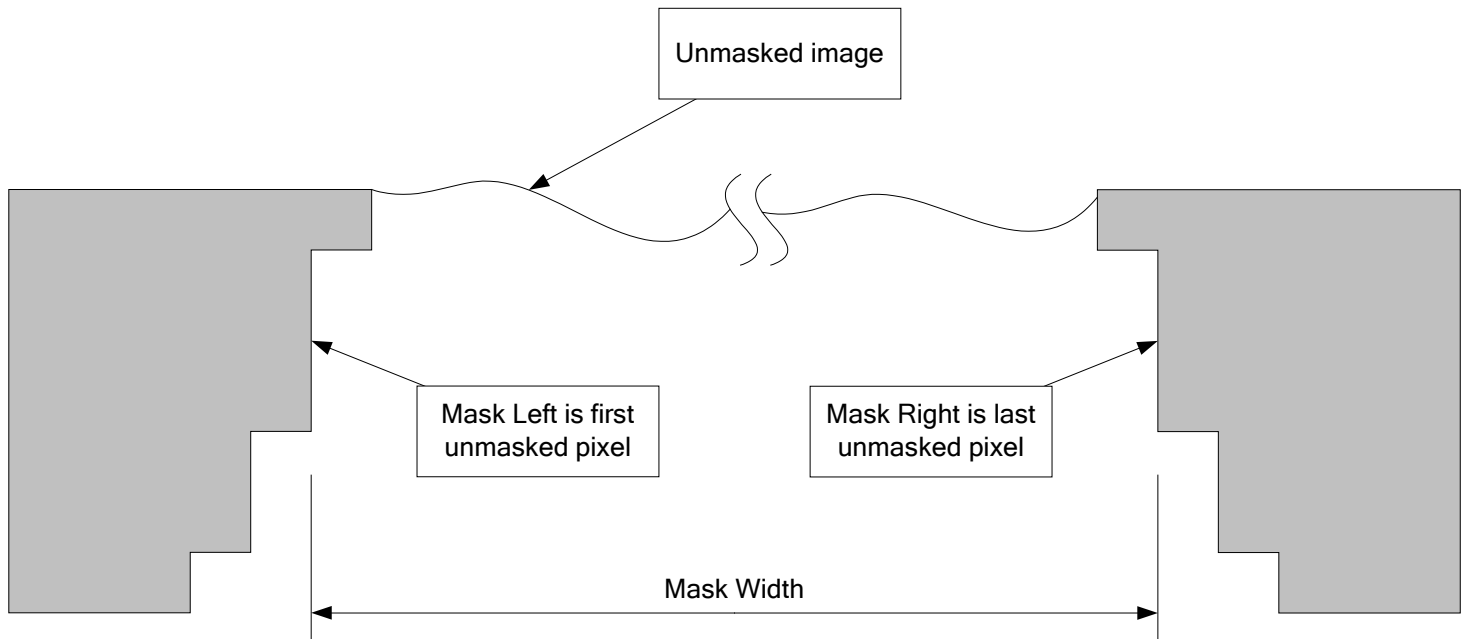

Figure 4-4: Mask Position and Size

4.5.1. Turning the Mask Object On and Off

To select the *mask* object press the **MASK** button. The *mask* object will blink momentarily (if the *mask* is On and the *obj blink* item on the *setup* menu is enabled) and the **MASK** button will blink indicating that the object is selected. The on screen display will be automatically turned on if the *OSD TIMER* item on the *SETUP* menu is not set to *Off* and will indicate if the *mask* object is On or Off. To turn the *mask* On or Off, press the **MASK** button when it is blinking. The *mask* object will be automatically de-selected after two minutes of inactivity on the front panel or when another object is selected. The **MASK** button will be illuminated brightly when it is On but not selected.

4.5.2. Controlling the Aspect Ratio of the Mask

Auto Aspect ratio	Off	1:1	4:3	14:9	16:9	1.67	1.85	2.35
-------------------	-----	-----	-----	------	------	------	------	------

The **AUTO ASPECT** button is used to control the aspect ratio of the *mask*, the *boxes* and the *ellipse* objects, and whether they are centred or not. The auto aspect ratio mode forces the *mask* object to be centred and its size to follow one of the following fixed aspect ratios: 1:1, 4:3(1.33), 14:9 (1.55), 16:9 (1.78), 1.67, 1.85:1, 2.35:1. (The on screen display will show the aspect ratio as *fixed aspect* and the centering as *centred*) When the *auto aspect ratio* mode is set to *Off* the *mask's* dimensions are not constrained to follow a fixed aspect ratio and the *setup menu force centre* item determines whether they will be forced to the centre of the raster. (The on screen display will show the aspect ratio as *user aspect* and the centering as *not centred*) See section 4.3.1 for more information about *auto aspect ratio* mode.

4.5.2.1. Centering the Mask on the Raster

When *auto aspect ratio mode* is On the *mask* object will always be centred on the raster. (The on screen display will show the object centering as *centred*) When *auto aspect ratio mode* is Off the *SETUP* menu item *force centre* controls whether the *mask* will be centred or not (see section 4.2.6.) When the *force centre* item is Off it is possible to independently position and size the *mask*, using the **SIZE** and **POS** buttons and turning one of the shaft encoders as outlined in the following sections. (The on screen display will show the centering as *not centred*)

4.5.2.2. Controlling the Mask Colour

Press the **COLOUR** button to adjust the *mask* colour. The colour of the *mask* object can be adjusted in the range of "0" through "14", in single digit increments, using either shaft encoder. The colours that will be displayed for each value are shown in Table 4-2.

4.5.3. Controlling the Mask Size

Press the **SIZE** button, when the *mask* button is blinking, to adjust the *mask* size. The size of the *mask* can be adjusted in one of three modes, depending on the setting of the *Setup menu Force Centre* item and the *Auto aspect ratio* mode. The remote panel display will show the *mask* size while the **SIZE** button is brightly illuminated. The On screen display will show the *mask* size as pixels and lines and as a percentage of its reference aperture. The *size adjust* function will be deselected after 3 minutes of panel activity, or when another button is pressed.

4.5.3.1. Controlling the *Mask Size (Objects centred, Aspect Ratio Off)*

Setup menu	Force centre	Yes
Auto Aspect ratio		Off

When *Force Centre* is On and *auto aspect ratio* is Off, the left shaft encoder is used to adjust the height and the right shaft encoder is used to adjust the width about the centre of the raster then the **SIZE** button is selected.

4.5.3.2. Controlling the *Mask Size(Aspect Ratio On)*

Auto Aspect ratio	1:1	4:3	14:9	16:9	1.67	1.85	2.35
-------------------	-----	-----	------	------	------	------	------

When *auto aspect ratio* mode is On, the shaft encoders are used to adjust the overall *size* of the *mask* proportionately about the centre of the raster based upon the *aspect ratio* selected. The left knob adjusts the top right corner of the *mask* and the right knob adjusts the bottom right corner of the *mask*.

4.5.3.3. Controlling the *Mask Size and Position (Objects not centred, Aspect Ratio Off)*

Setup menu	Force centre	no
Auto Aspect ratio		off

When *Force Centre* is Off and, and *auto aspect ratio* mode is Off the left shaft encoder is used to adjust the bottom side of the *mask*, and the right shaft encoder is used to adjust the right side of the *mask*.

4.5.4. Controlling the *Mask Position*

Press the **POS** button while the *mask* button is blinking to control the position of the *mask*. When *auto aspect ratio* mode is Off and the *Setup menu Force Centre* item is set to *no* the left shaft encoder is used to adjust the vertical position of the *mask*, i.e. move the *mask* up or down, and the right shaft encoder is used to adjust the horizontal position of the *mask*, i.e. move the *mask* left or right. The remote panel display will show the mask position while the **POS** button is brightly illuminated. The *position adjust* function will be deselected after 3 minutes of panel activity, or when another button is pressed.

If one of the *auto aspect ratios* is selected or the *Setup menu Force Centre* item is set to *yes*, then the position of the *mask* is fixed to the centre of the clean aperture. The remote panel display will show *Mask centred*.

4.6. CONTROLLING THE CURSOR OBJECT

The *cursor* object consists of a horizontal and vertical line that intersect at their mid points. The lines are shaped to avoid sharp transitions in the video. Line width may be adjusted using the *Line Width* attribute. The locations of the cursor lines shown is the centre of the line.



You can only control one cursor object with the Desktop Remote panel

4.6.1. Turning the *Cursor* Object On and Off

To select the *cursor* object press the **CURSOR** button. The *cursor* object will blink momentarily (if the *cursor* is On and the *obj blink* item on the *setup* menu is enabled) and the **CURSOR** button will blink indicating that the object is selected. The on screen display will be automatically turned on if the *OSD TIMER* item on the *SETUP* menu is not set to *Off* and will indicate if the *cursor* object is On or Off. To turn the *cursor* On or Off, press the **CURSOR** button when it is blinking. The *cursor* object will be automatically de-selected after two minutes of inactivity on the front panel or when another object is selected. The **CURSOR** button will be illuminated brightly when it is On but not selected.

4.6.2. Centering the *Cursor* on the Raster

When *auto aspect ratio mode* is On the *cursor* object will always be centred on the raster. (The OSD will show *centred*.) When *auto aspect ratio mode* is Off the *SETUP* menu item *force centre* controls whether the *cursor* will be centred or not (see section 4.2.6 for more information about *auto aspect ratio mode*). When the *force centre* item is Off it is possible to independently position and size the *cursor*, using the **SIZE** and **POS** buttons and turning one of the shaft encoders as outlined in the following sections. (The OSD will show *not centred*.)

4.6.2.1. Controlling the *Cursor* Colour

Press the **COLOUR** button to adjust the *cursor* colour. The colour of the *cursor* object can be adjusted in the range of "0" through "14", in single digit increments, using either shaft encoder. The colours that will be displayed for each value are shown in Table 4-2.

4.6.2.2. Controlling the *Cursor* Size

Press the **SIZE** button, when the *cursor* button is blinking, to adjust the *cursor* size. The shaft encoders are used to adjust the size of the *cursor*. The remote panel display will show the *cursor* size while the **SIZE** button is brightly illuminated. The On screen display will show the *cursor* size as pixels and lines and as a percentage of its reference aperture. The *size adjust* function will be deselected after 3 minutes of panel activity, or when another button is pressed.

4.6.2.3. Controlling the *Cursor* Position (*Objects not centred, Aspect Ratio Off*)

Press the **POS** button while the *cursor* button is blinking to control the position of the *cursor*. When *auto aspect ratio mode* is Off and the *Setup menu Force Centre* item is set to *no* the left shaft encoder is used to adjust the vertical position of the *cursor*, i.e. move the *cursor* up or down, and the right shaft encoder is used to adjust the horizontal position of the *cursor*, i.e. move the *cursor* left or right. The remote panel display will show the *cursor* position while the **POS** button is brightly illuminated. The *position adjust* function will be deselected after 3 minutes of panel activity, or when another button is pressed.

4.7. CONTROLLING THE BOX OBJECTS

There are two *box* objects, called *box1* and *box2*. Each of the *box* objects can be controlled independently, and operate the same way. Often *box1* is used to mark the safe action area and *box2* is used to mark the safe title area. References throughout this section to the *box* object apply to either *box1* or *box2*. The box perimeter lines are shaped to avoid sharp transitions in the video. Line width may be adjusted using the *Line Width* attribute. The locations of the box perimeter lines shown is the centre of the line.

4.7.1. Turning the Box Objects On and Off

To select the *box1* object press the **BOX1** button. The *box1* object will blink momentarily (if the *box1* is On and the *obj blink* item on the *setup* menu is enabled) and the **BOX1** button will blink indicating that the object is selected. The on screen display will be automatically turned on if the *OSD TIMER* item on the *SETUP* menu is not set to *Off* and will indicate if the *box1* object is On or Off. To turn the *box1* On or Off, press the **BOX1** button when it is blinking. The *box1* object will be automatically de-selected after two minutes of inactivity on the front panel or when another object is selected. The **BOX1** button will be illuminated brightly when it is On but not selected.

To select the *box2* object press the **BOX2** button. The *box2* object will blink momentarily (if the *box2* is On and the *obj blink* item on the *setup* menu is enabled) and the **BOX2** button will blink indicating that the object is selected. The on screen display will be automatically turned on if the *OSD TIMER* item on the *SETUP* menu is not set to *Off* and will indicate if the *box2* object is On or Off. To turn the *box2* On or Off, press the **BOX2** button when it is blinking. The *box2* object will be automatically de-selected after two minutes of inactivity on the front panel or when another object is selected. The **BOX2** button will be illuminated brightly when it is On but not selected.

4.7.2. Controlling the Aspect Ratio of the Box

Auto Aspect ratio	Off	1:1	4:3	14:9	16:9	1.67	1.85	2.35
-------------------	-----	-----	-----	------	------	------	------	------

The **AUTO ASPECT** button is used to control the aspect ratio of the *mask*, the *boxes* and the *ellipse* objects, and whether they are centred or not. The auto aspect ratio mode forces the *box* objects to be centred and their size to follow one of the following fixed aspect ratios: 1:1, 4:3(1.33), 14:9 (1.55), 16:9 (1.78), 1.67, 1.85:1, 2.35:1. (The on screen display will show the aspect ratio as *fixed aspect* and the centering as *centred*) When the *auto aspect ratio* mode is set to *Off* the *box* dimensions are not constrained to follow a fixed aspect ratio and the *setup menu force centre* item determines whether they will be forced to the centre of the raster. (The on screen display will show the aspect ratio as *user aspect* and the centering as *not centred*) See section 4.3.1 for more information about *auto aspect ratio* mode.

4.7.3. Centering the Box on the Raster

When *auto aspect ratio mode* is On the *boxes* will always be centred on the raster. (The on screen display will show the object centering as *centred*) When *auto aspect ratio mode* is Off the *SETUP* menu item *force centre* controls whether the *boxes* will be centred or not (see section 4.2.6.) When the *force centre* item is Off it is possible to independently position and size the whole *box*, using the **SIZE** and **POS** buttons and turning one of the shaft encoders as outlined in the following sections. (The on screen display will show the centering as *not centred*)

4.7.3.1. Controlling the Box Colour

Press the **COLOUR** button to adjust the *box* colour. The colour of the *box* object can be adjusted in the range of “0” through “14”, in single digit increments, using either shaft encoder. The colours that will be displayed for each value are shown in Table 4-2.

4.7.4. Controlling the *Box* Size

Press the **SIZE** button, when the *box* its button is blinking, to adjust the *box* size. The size of the *box* can be adjusted in one of four modes, depending on the setting of the *Setup menu Force Centre* item and the *Auto aspect ratio* mode. The remote panel display will show the *box* size while the **SIZE** button is brightly illuminated. The On screen display will show the *grid* size as pixels and lines and as a percentage of its reference aperture. The *size adjust* function will be deselected after 3 minutes of panel activity, or when another button is pressed.

4.7.4.1. Controlling the *Box* Size (*Objects* centred, *Aspect Ratio* Off)

Setup menu	Force centre	Yes
Auto Aspect ratio		Off

When *Force Centre* is On and *auto aspect ratio* is Off, the left shaft encoder is used to adjust the height and the right shaft encoder is used to adjust the width about the centre of the raster then the **SIZE** button is selected.

4.7.4.2. Controlling the *Box* Size (*Aspect Ratio* On)

Auto Aspect ratio	1:1	4:3	14:9	16:9	1.67	1.85	2.35
-------------------	-----	-----	------	------	------	------	------

When *auto aspect ratio* mode is On, the shaft encoders are used to adjust the overall *size* of the *box* proportionately about the centre of the raster based upon the *aspect ratio* selected. The left knob adjusts the top right corner of the *box* and the right knob adjusts the bottom right corner of the *box*.

4.7.4.3. Controlling the *Box* Size and Position (*Objects* not centred, *Aspect Ratio* Off)

Setup menu	Force centre	no
Auto Aspect ratio		off

When *Force Centre* is Off and, and *auto aspect ratio* mode is Off the left shaft encoder is used to adjust the bottom side of the *box*, and the right shaft encoder is used to adjust the right side of the *box*.

4.7.5. Controlling the *Box* Position

Press the **POS** button while the *box* button is blinking to control the position of the *box*. When *auto aspect ratio* mode is Off and the *Setup menu Force Centre* item is set to *no* the left shaft encoder is used to adjust the vertical position of the *box*, i.e. move the *box* up or down, and the right shaft encoder is used to adjust the horizontal position of the *box*, i.e. move the *box* left or right. The remote panel display will show the *box* position while the **POS** button is brightly illuminated. The *position adjust* function will be deselected after 3 minutes of panel activity, or when another button is pressed.

If one of the *auto aspect ratios* is selected or the *Setup menu Force Centre* item is set to *yes*, then the position of the *box* is fixed to the centre of the clean aperture. The display will show *Box centred*.

4.8. CONTROLLING THE ELLIPSE OBJECT

4.8.1. Turning the *Ellipse* Object On and Off

To select the *ellipse* object press the **ELLIPSE** button. The *ellipse* object will blink momentarily (if the *ellipse* is On and the *obj blink* item on the *setup* menu is enabled) and the **ELLIPSE** button will blink indicating that the object is selected. The on screen display will be automatically turned on if the *OSD TIMER* item on the *SETUP* menu is not set to *Off* and will indicate if the *ellipse* object is On or Off. To turn the *ellipse* On or Off, press the **ELLIPSE** button when it is blinking. The *ellipse* object will be automatically de-selected after two minutes of inactivity on the front panel or when another object is selected. The **ELLIPSE** button will be illuminated brightly when it is On but not selected. The *ellipse* line is shaped to avoid sharp transitions in the video. Line width may be adjusted using the *Line Width* attribute. The locations of the *ellipse* boundaries shown is the centre of the line.

4.8.2. Controlling the Aspect Ratio of the *Ellipse*

Auto Aspect ratio	Off	1:1	4:3	14:9	16:9	1.67	1.85	2.35
-------------------	-----	-----	-----	------	------	------	------	------

The **AUTO ASPECT** button is used to control the aspect ratio of the *mask*, the *boxes* and the *ellipse* objects, and whether they are centred or not. The auto aspect ratio mode forces the *ellipse* object to be centred and its size to follow a 1:1 aspect ratio. (The on screen display will show the aspect ratio as *fixed aspect* and the centering as *centred*) When the *auto aspect ratio* mode is set to *Off* the *ellipse's* dimensions are not constrained to follow a fixed aspect ratio and the *setup menu force centre* item determines whether they will be forced to the centre of the raster. See section 4.3.1 for more information about *auto aspect ratio* mode. (The on screen display will show the aspect ratio as *user aspect* and the centering as *not centred*)

4.8.2.1. Centering the *Ellipse* on the Raster

When *auto aspect ratio mode* is On the *ellipse* object will always be centred on the raster. (The on screen display will show the object centering as *centred*) When *auto aspect ratio* mode is Off the *SETUP* menu item *force centre* controls whether the *ellipse* will be centred or not (see section 4.2.6.) When the *force centre* item is Off it is possible to independently position and size the *ellipse*, using the **SIZE** and **POS** buttons and turning one of the shaft encoders as outlined in the following sections. (The on screen display will show the centering as *not centred*)

4.8.2.2. Controlling the *Ellipse* Colour

Press the **COLOUR** button to adjust the *ellipse* colour. The colour of the *ellipse* object can be adjusted in the range of "0" through "14", in single digit increments, using either shaft encoder. The colours that will be displayed for each value are shown in Table 4-2.

4.8.3. Controlling the *Ellipse* Size

Press the **SIZE** button, when the *ellipse* its button is blinking, to adjust the *ellipse* size. The size of the *ellipse* can be adjusted in one of three modes, depending on the setting of the *Setup menu Force Centre* item and the *Auto aspect ratio* mode. The remote panel display will show the *ellipse* size while the **SIZE** button is brightly illuminated. The On screen display will show the *mask* size as pixels and lines and as a percentage of its reference aperture. The *size adjust* function will be deselected after 3 minutes of panel activity, or when another button is pressed.

4.8.3.1. Controlling the *Ellipse* Size (*Objects centred, Aspect Ratio Off*)

Setup menu	Force centre	Yes
Auto Aspect ratio		Off

When *Force Centre* is On and *auto aspect ratio* is Off, the left shaft encoder is used to adjust the height and the right shaft encoder is used to adjust the width about the centre of the raster then the **SIZE** button is selected.

4.8.3.2. Controlling the *Ellipse* Size (*Aspect Ratio On*)

Auto Aspect ratio	1:1	4:3	14:9	16:9	1.67	1.85	2.35
-------------------	-----	-----	------	------	------	------	------

When *auto aspect ratio* mode is On, the shaft encoders are used to adjust the overall *size* of the *ellipse* proportionately about the centre of the raster based upon the *aspect ratio* selected. The left knob adjusts the top right corner of the *ellipse* and the right knob adjusts the bottom right corner of the *ellipse*.

4.8.3.3. Controlling the *Ellipse* Size and Position (*Objects not centred, Aspect Ratio Off*)

Setup menu	Force centre	no
Auto Aspect ratio		off

When *Force Centre* is Off and, and *auto aspect ratio* mode is Off the left shaft encoder is used to adjust the bottom side of the *ellipse*, and the right shaft encoder is used to adjust the right side of the *ellipse*.

4.8.4. Controlling the *Ellipse* Position

Press the **POS** button while the *ellipse* button is blinking to control the position of the *ellipse*. When *auto aspect ratio* mode is Off and the *Setup menu Force Centre* item is set to *no* the left shaft encoder is used to adjust the vertical position of the *ellipse*, i.e. move the *ellipse* up or down, and the right shaft encoder is used to adjust the horizontal position of the *ellipse*, i.e. move the *ellipse* left or right. The remote panel display will show the *ellipse* position while the **POS** button is brightly illuminated. The *position adjust* function will be deselected after 3 minutes of panel activity, or when another button is pressed.

If one of the *auto aspect ratios* is selected or the *Setup menu Force Centre* item is set to *yes*, then the position of the *ellipse* is fixed to the centre of the clean aperture. The display will show *Ellipse centred*.

4.9. LOADING FACTORY PRESETS

The **FACT PRESET** button is used to recall the most recently used *factory preset*. Turn one of the shaft encoder knobs to cycle through the available *factory presets*. The name of the selected preset will be shown on the front panel display, and the selected collection of object settings will be loaded into to the Graticule Generator. The *factory presets* available at the time of printing are shown in Chapter 7. In the front panel descriptions of the *factory presets* CA refers to clean aperture and PA refers to production aperture.

4.10. WORKING WITH THE USER PRESETS

The Graticule Generator has ten memory locations to store user defined presets. Each preset contains a collection of object parameters that define what objects are on, and settings for the objects. There are ten *user preset* locations for each video standard. Each of the *user preset* locations can be write-protected, or can left unlocked, so users can save their favourite settings. When the Graticule Generator is reset to its factory default condition, the ten *user preset* locations are filled with ten of the *factory presets*. The state of the **SHIFT LOCK** button determines whether *user preset* locations 0 to 4 or 5 to 9 will be selected with the **USER PRESET** buttons. Press the **SHIFT LOCK** button to toggle the *shift lock* function on or off. *Shift lock* is *On* when the **SHIFT LOCK** button is brightly illuminated.

4.10.1. Saving User Presets

To save the current object settings into one of the ten *user preset* memory locations, press the **PRESET SAVE** button. The Front panel display will show *Store Preset #*. Select the location you wish to store the settings to using the **SHIFT LOCK** and **USER PRESET** buttons. The Front panel display will show *SAVE to store n* where *n* is the number of the *user preset*. Press the **PRESET SAVE** button a second time to confirm the operation (The Front panel display will show *Preset n stored*) or press the **ESC** button to abort the store operation. If the user attempts to store a preset into a write protected location the front panel will display the message *Preset n locked*.



User Presets cannot be deleted directly from memory they can only be overwritten by another configuration saved to the same memory location.

4.10.2. Recalling User Presets

To load the current object settings from one of the ten *user preset* memory locations; select the location you wish to recall the settings from using the **SHIFT LOCK** and **USER PRESET** buttons.



Recalling one of the *user presets* will overwrite the current object settings and can not be undone. Make sure you want to overwrite your current settings before you recall one of the *user presets*



User presets cannot be recalled if the *keyer* is off.

4.10.3. Customizing the User Preset Names

The User presets can be uploaded to a computer text file using the Ethernet port. You can edit this text file giving each of the presets a more 'user friendly' name, and then download the file back to the Graticule generator. The names that you have assigned will be shown on the front panel when you recall the user presets using the procedure in section 4.10.2. You can also download this user preset file to multiple Graticule generators to pre configure them with your customized preset settings. See section 5.4 for information on uploading and downloading user presets.

CHAPTER 5: TECHNICAL DESCRIPTION

TABLE OF CONTENTS

5. TECHNICAL DESCRIPTION	5-1
5.1. SPECIFICATIONS	5-1
5.1.1. Serial Digital Video Inputs	5-1
5.1.2. Serial Digital Video Outputs.....	5-1
5.1.3. Digital (DVI) Video Output	5-1
5.1.4. GPI Control Port.....	5-1
5.1.5. Upgrade Control Port.....	5-2
5.1.6. Remote Panel Port	5-2
5.1.7. Ethernet.....	5-2
5.1.8. Electrical.....	5-2
5.1.9. Physical.....	5-3
5.2. SERVICING INSTRUCTIONS	5-3
5.2.1. Changing the Fuses	5-3
5.3. UPGRADING FIRMWARE	5-3
5.3.1. Upgrading the Firmware Using FTP	5-4
5.3.1.1. Step 1 – Determine the IP Addresses	5-4
5.3.1.2. Step 2 – Establishing a Valid Network Connection.....	5-6
5.3.1.3. Step 3 – Upgrading the Application Code.....	5-6
5.3.1.4. Step 4 – Completing the Upgrade	5-8
5.3.2. Upgrading the Firmware Using RS-232 Serial Cable	5-8
5.3.2.1. Step 1 – Setup	5-8
5.3.2.2. Step 2 – Invoke Upload Mode From The Terminal Program.....	5-8
5.3.2.3. Step 3 – Uploading the New Firmware	5-9
5.3.2.4. Step 4 – Completing the Upgrade	5-9
5.4. UPLOADING AND DOWNLOADING THE USER PRESETS TO A COMPUTER	5-10
5.4.1. Downloading Preset Files from the Graticule Generator	5-10
5.4.2. Editing User Preset files	5-11
5.4.3. Uploading Preset Files to the Graticule Generator.....	5-11
5.5. WRITE-PROTECTING THE USER PRESETS	5-12
5.6. RESTORING THE GRATICULE GENERATOR TO ITS FACTORY DEFAULTS	5-13

This page left intentionally blank

5. TECHNICAL DESCRIPTION

5.1. SPECIFICATIONS

5.1.1. Serial Digital Video Inputs

Standards:

Model HD9690 SMPTE ST 292-1 (1.5 Gb/s) – see Table 2-4

Model HD9690-444 SMPTE ST 372 (dual Link 1.5 Gb/s) or SMPTE ST 292-1 (1.5 Gb/s) – see Table 2-4

Number of Inputs:

Model HD9690 1

Model HD9690-444 1 dual link input

Connector: BNC per IEC 60169-8 Amendment 2.

Equalisation:

HD Video Stds: Automatic up to 50m on Input A and 140m on Input B with Belden 1694 or equivalent cable

Return Loss:

Input A: > 15 dB up to 1.0 Gb/s, >10dB at 1.5 Gb/s

Input B: > 15 dB up to 1.5 Gb/s

5.1.2. Serial Digital Video Outputs

Standard: Same as Input

Number of Outputs:

Model HD9690 3 outputs

Model HD9690-444 2 dual link outputs, 1 single link output

Connector: BNC per IEC 60169-8 Amendment 2.

Signal Level: 800mV nominal

DC Offset: 0V ±0.5V

Rise and Fall Time:

HD Video Stds: 200ps nominal

Overshoot: <10% of amplitude

Wide Band Jitter: < 0.2 UI

Output Return Loss: > 10 dB up to 1.5 Gb/s

5.1.3. Digital (DVI) Video Output

Standards: VESA (DVI-I, for DVI-D and RGBHV outputs)

Type: DVI-I (female connector)

Resolution: 1920x1080 or 720z1280 – same as video input

Signal Level: 1V nominal

5.1.4. GPI Control Port

Number of Inputs: 8 opto-isolated, active high or active low, programmable functions

Connector: Female DB-9

5.1.5. Upgrade Control Port

Standard: RS 232
Connector: Female DB-9
Baud Rate: 115200
Format: 8 bits, no parity, and 2 stop bits

5.1.6. Remote Panel Port

Standard: RS-422, 9600 baud rate
Connector: Female DB-9
Protocol: Remote Control Panel

5.1.7. Ethernet

Network Type: Fast Ethernet 100 Base-TX IEEE 802.3u standard for 100 Mbps baseband CSMA/CD local area network
Ethernet 10 Base-T IEEE 802.3 standard for 10 Mbps baseband CSMA/CD local area network
Connector: RJ-45
Function: Firmware upgrades via FTP, Saving and recalling user presets via FTP

5.1.8. Electrical

Main Unit:

Voltage: Auto ranging 100 ⇔ 240 Volts AC, 50/60 Hz
Fuse Rating: 250 V, 1amp time delay
Power: 40 watts

Rack Mount Control Panel:

Voltage: 12 VDC, Auto ranging 100 ⇔ 240 Volts AC, 50/60 Hz adapter provided.
Fuse Rating: internally fused
Power: 10 watts

Desktop Control Panel:

Voltage: 12 VDC, Auto ranging 100 ⇔ 240 Volts AC, 50/60 Hz adapter provided.
Fuse Rating: internally fused
Power: 10 watts

Safety: ETL Listed, complies with EU safety directives
EMI/RFI: Complies with FCC Part 15 Class A regulations
Complies with EU EMC directive

5.1.9. Physical

Dimensions:

Main Unit: 19" W x 1.75" H x 18.75" D.
(483mm W x 45mm H x 477mm D)
Rack Mount Control Panel: 19" W x 1.75" H x 4.25" D.
(483mm W x 45mm H x 110mm D)
Desktop Control Panel: 7.75" W x 2.0" H x 6.5" D.
(197mm W x 50mm H x 160mm D)

Weight:

Main Unit: 8 lbs. (3.5Kg)
Rack Mount Control Panel:
Desktop Control Panel:

5.2. SERVICING INSTRUCTIONS



CAUTION – These servicing instructions are for use by qualified service personnel only. To reduce risk of electric shock do not perform any servicing instructions in this section of the manual unless you are qualified to do so.



Make sure that both power cords are disconnected before opening the top cover of the unit.

5.2.1. Changing the Fuses

The fuse holder is located inside the power entry module. To change the fuses, disconnect the line cord from the power entry module and pull out the fuse holder from the power entry module using a small screwdriver. The fuse holder contains two fuses, one for the line and one for the neutral side of the mains connection. Pull out the blown fuse and place a fuse of the correct value in its place. Use time delay 5 x 20 mm fuses rated for 250 Volts with a current rating of 1 amp. (T1AL250V) Carefully reinsert the fuse holder into the power entry module.



Check that the line fuse is rated for the correct value marked on the rear panel. Never replace with a fuse of greater value.

5.3. UPGRADING FIRMWARE

The HD9690 contains firmware that is contained in a FLASH EPROM device. From time to time firmware updates will be provided to add additional features to the unit.

There are two methods of updating the firmware in the HD9690: File Transfer Protocol (FTP) and Serial Upload. Due to the large size of the firmware binary file the FTP method is the preferred method of updating the firmware.

Prior to initiating the upgrade process:

- Confirm the version of code currently installed on the unit by using the front panel display.
- Download the new application code from the Evertz FTP site (www.evertz.com) Unzip the file into a temporary working folder on your PC.

5.3.1. Upgrading the Firmware Using FTP

You will need the following equipment in order to update the Firmware:

- PC with available communications port and ethernet network port. The communication speed is 1152600 baud, therefore a 486 PC or better with a 16550 UART based communications port is recommended.
- “Straight-thru” serial extension cable (DB9 female to DB9 male) or (DB25 female to DB9 male).
- Appropriate ethernet cable as outlined in section 2.5.
- Terminal program such as HyperTerminal
- New firmware supplied by Evertz.

5.3.1.1. Step 1 – Determine the IP Addresses

Before any FTP (file transfer protocol) upgrades can be initiated, the user must determine the IP address of the HD9690unit. Both the PC/laptop and the unit must be on the same subnet for the FTP upgrade to work properly.

1. Connect a ‘straight through’ serial cable to the **UPGRADE/COM1** DB9 connector on the rear panel
2. Connect the 9 pin female connector on the end of the serial cable to the PCs’ RS-232 communications port
3. Start the terminal program.
4. Configure the port settings of the terminal program as follows:

Baud	115200
Parity	no
Data bits	8
Stop bits	2
Flow Control	None

5. Once the unit is powered-up, the HyperTerminal connection displays boot-up status information and once completed, ends with the “Status Message” as shown below:

```
Initialization Completed - HD9690 Running
```

6. Press the <Enter> key to see the main Menu.

```
Initialization Completed - HD9690 Running

-----
|                               |
|               Main Menu      |
|      (HD9690-444 Desk Build b9295) |
|                               |
|-----|
| ( 1) Network Configuration   |
| ( 2) Engineering Debug Utility |
|                               |
| (X) Exit                     |
|>                             |
```

7. Press the number <1> key to enter the Network Configuration menu that is used to set the IP address properties for the unit.

```
-----
|                               |
|       Network Configuration   |
|      (HD9690-444 Desk Build b9295) |
|                               |
|-----|
| MAC: 00:02:c5:fe:da:34       |
|                               |
| ip address:      192.170.1.1  |
| netmask address: 255.255.255.0 |
| gateway:        0.0.0.0      |
| broadcast address: 192.170.1.255 |
| DHCP enabled: False          |
|                               |
|-----|
| ( 1) Set IP Address          |
| ( 2) Set Netmask            |
| ( 3) Set Gateway            |
| ( 4) Set Broadcast Address  |
| ( 5) Use DHCP               |
|                               |
| (S) Save and Exit          |
| (X) Exit                   |
|>                           |
```

8. From the Network configuration menu selecting options “1” through “4” allows the user to set the networking parameters of the unit. If this unit is running on a public LAN enabled with DHCP, then option “5” allows the networking system to assign a non-conflicting IP address for this module. After completing the IP configurations, save and exit this menu by selecting “S”. The unit ships with DHCP disabled (or DHCP enabled set to “FALSE”). If you are not sure whether you should use this option, contact your networking/IT administrator.

Once you return to the Main Menu, reboot the unit so that the new settings will take effect. You can do this using the *Reboot Now* menu item on the *FIRMWARE* menu, or you can disconnect the power to the unit and then plug it back in.

5.3.1.2. Step 2 – Establishing a Valid Network Connection

9. Connect a crossover network cable from the PC/laptop to the unit
10. Open a DOS window. This can be accomplished by using the run command under the start button, type “cmd”; see figure below for an example:

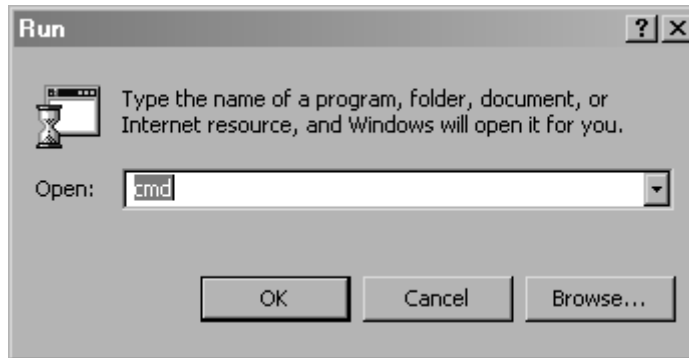

11. “Ping” the IP address of the module being upgraded to confirm that you have a valid network connection. In the command prompt window type: `ping xxx.xxx.xxx.xxx <Enter>` (IP address of the module)

If a proper network connection has been established, a “reply” is displayed on the DOS window. If there is a faulty network connection, a “Destination Host Unreachable” message is provided. If this occurs, either the IP addresses of the nodes should be verified or the network (Ethernet) cable is faulty. For more information, please see the INSTALLATION & CONFIGURATION chapter of this manual.

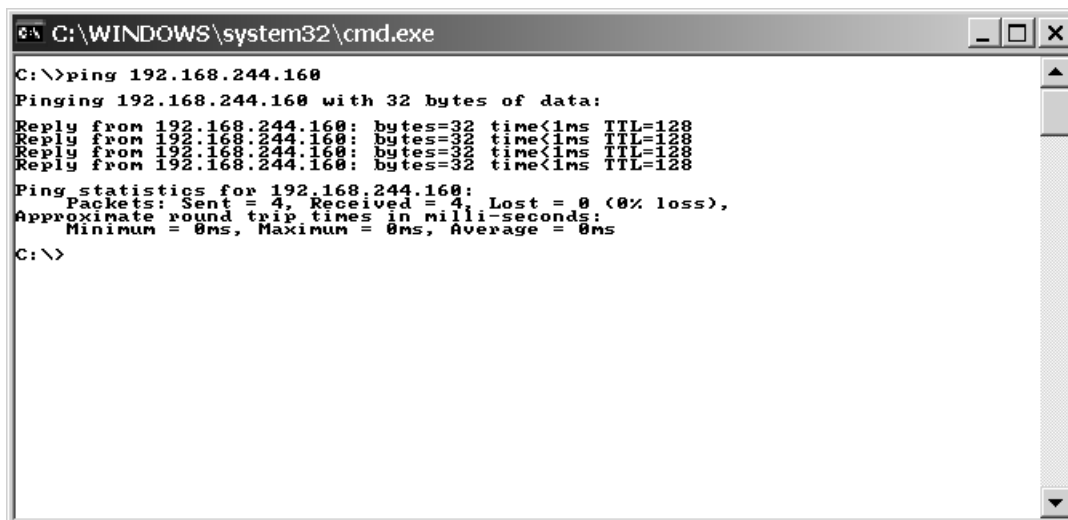

5.3.1.3. Step 3 – Upgrading the Application Code

12. Obtain the new application code and place it on the local drive of the PC
13. In the command prompt window type: `ftp xxx.xxx.xxx.xxx` (IP address of the module)
14. Press the <Enter> key when prompted for a “Username”.

5.3.1.4. Step 4 – Completing the Upgrade

23. Disconnect the power to the unit and then plug it back in to reboot the unit.
24. You can now close the DOS window and disconnect the network cable.

5.3.2. Upgrading the Firmware Using RS-232 Serial Cable



This method of upgrading the firmware will take over 15 minutes and is not recommended unless the FTP method fails.

You will need the following equipment in order to update the Firmware

- PC with available communications port. The communication speed is 115200 baud, therefore a 486 PC or better with a 16550 UART based communications port is recommended.
- “Straight-thru” serial extension cable (DB9 female to DB9 male) or (DB25 female to DB9 male).
- Terminal program that is capable of Xmodem file transfer protocol. (such as HyperTerminal)
- New firmware supplied by Evertz.

5.3.2.1. Step 1 – Setup

1. Connect a ‘straight through’ serial cable to the **UPGRADE/COM1** DB9 connector on the rear panel
2. Connect the 9 pin female connector on the end of the serial update cable to the PCs’ RS-232 communications port
3. Connect the 9 pin connector on the end of the serial update cable to the PCs’ RS-232 communications port
4. Start the terminal program.
5. Configure the port settings of the terminal program as follows:

Baud	115200
Parity	no
Data bits	8
Stop bits	2
Flow Control	None

5.3.2.2. Step 2 – Invoke Upload Mode From The Terminal Program

7. Power up the HD9690. After the unit powers up, a banner with the boot code version information should appear in the terminal window. The cursor to the right of the word “BOOT>” should be spinning for about 5 seconds then the unit will continue to boot. While the cursor is spinning press Ctrl-X to abort the boot-up process.

For example:

```
PPC BOOT>
```

8. The following is a list of possible reasons for failed communications:

- Defective Serial Upgrade cable.
- Wrong communications port selected in the terminal program.
- Improper port settings in the terminal program. (Refer to step 7 for settings). Note that HyperTerminal will not change port settings while connected. Click on HyperTerminal's "Disconnect" Button then click the "Reconnect" button to activate changes to the port settings.

9. Hit the <ENTER> key on your computer once.

10. Type the word "upload", without quotes, and hit the <ENTER> key once.

11. You should now see a prompt asking you to upload the file.

5.3.2.3. Step 3 – Uploading the New Firmware

12. Upload the "*.bin" file supplied using the X-Modem transfer protocol of your terminal program. If you do not start the upload within 10 minutes the unit's Boot code will time out. You can restart the upgrade process by power cycling the unit.

13. When the transfer is complete (can take up to 15+ minutes) the terminal will return to the PPCBOOT prompt

For Example:

```
UPLOAD OKAY
PPC BOOT> |
```

14. The following is a list of possible reasons for a failed upload:

- If you get the message "transfer cancelled by remote" you must restart the terminal program and load the bin file, then remove and install the module again.
- The supplied "*.bin" file is corrupt.
- Wrong file specified to be uploaded.
- Wrong file transfer protocol used – make sure you specify Xmodem, not Xmodem 1K.
- The PCs' RS-232 communications port can't handle a port speed of 57600.
- Noise induced into the Serial Upgrade cable.

5.3.2.4. Step 4 – Completing the Upgrade

15. Power cycle the unit. It should proceed through a normal boot up sequence.

18. You can now close the terminal program and disconnect the RS-232 serial cable from the PC and the unit.

5.4. UPLOADING AND DOWNLOADING THE USER PRESETS TO A COMPUTER

To download the user presets to a computer you will need to establish an FTP connection to the graticule generator. First you will have to configure the IP addresses in the graticule generator for use on your network as described in sections 5.3.1.1 and 5.3.1.2.

5.4.1. Downloading Preset Files from the Graticule Generator

To download a preset file from the graticule generator to the local directory

1. In the command prompt window type: `ftp xxx.xxx.xxx.xxx` (IP address of the module)
2. Press the <Enter> key when prompted for a “Username”.
3. Press the <Enter> key when prompted for a “Password”. A message indicating that you logged in is displayed.
4. At the “FTP>” prompt type `quote site createfile` to create a text file in the Graticule generator that contains the values for the ten user presets. The Graticule generator responds with 200 to indicate successful creation of the file.
5. At the “FTP>” prompt type: `get presetfile.txt` to send the preset text file from the Graticule generator to the computer. The file will be saved in the local directory on the computer.



During this time it is mandatory that all power cycles of the unit be avoided. The figure below displays a successful FTP session.

6. At the “FTP>” prompt type `quit` to exit the FTP procedure. The Graticule generator responds with 221 Goodbye

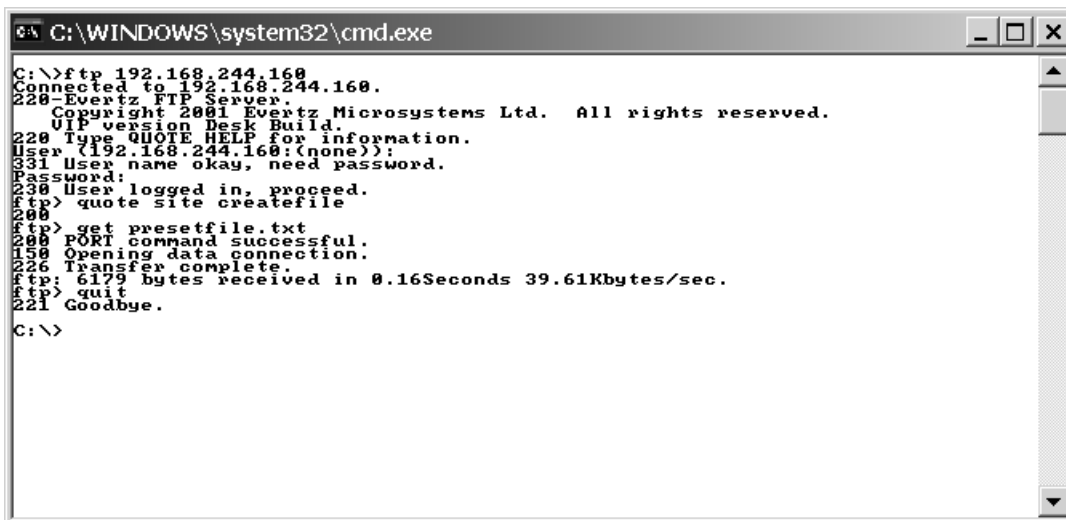

```
C:\WINDOWS\system32\cmd.exe
C:\>ftp 192.168.244.160
Connected to 192.168.244.160.
220-Evertz FTP Server.
  Copyright 2001 Evertz Microsystems Ltd. All rights reserved.
  VIP version Desk Build.
220 Type QUOTE HELP for information.
User (192.168.244.160:(none)):
331 User name okay, need password.
Password:
230 User logged in, proceed.
ftp> quote site createfile
200
ftp> get presetfile.txt
200 PORT command successful.
150 Opening data connection.
226 Transfer complete.
ftp: 6179 bytes received in 0.16Seconds 39.61Kbytes/sec.
ftp> quit
221 Goodbye.
C:\>
```

5.4.2. Editing User Preset files

The User Preset file saved on the computer is a text file containing the information for all ten user presets for each video standard. Each video standard is contained in its own section of the file.

At the beginning of each section is a header containing the video standard, preset number and preset name as shown below. You can edit the preset number and name to best suit your needs. Preset names are limited to 16 alphanumeric characters. Preset numbers are restricted to the range 0 to 9.

```
{VIDEO 2 (1080P24PSF)
{PRESET 1 (Preset 1 load)
{OBJECT 0
1
111
62
1808
1017
...
```



Do not attempt to edit any other lines of the preset file, as this will corrupt the preset values.



You must supply a name or the graticule generator will substitute a default name when it loads the file.

5.4.3. Uploading Preset Files to the Graticule Generator

To upload a preset file to the graticule generator from the local directory



Presets that are protected may still be overwritten by uploading a user preset file. Proceed with Caution.

1. In the command prompt window type: `ftp xxx.xxx.xxx.xxx` (IP address of the module)
2. Press the <Enter> key when prompted for a "Username".
3. Press the <Enter> key when prompted for a "Password". A message indicating that you logged in is displayed.
4. At the "FTP>" prompt type: `put presetfile.txt` to send the preset text file from the Graticule generator from the local directory on the computer.
5. If the preset text file is not local to where you are performing the ftp, then include the path with the name (For example: `put c:\presets\presetfile.txt`)



During this time it is mandatory that all power cycles of the unit be avoided. The figure below displays a successful FTP session.

6. At the “FTP>” prompt type `quote site loadfile` to overwrite the user presets in the Graticule generator with the preset values contained in the text file.
7. At the “FTP>” prompt type `quit` to exit the FTP procedure. The Graticule generator responds with 221 Goodbye

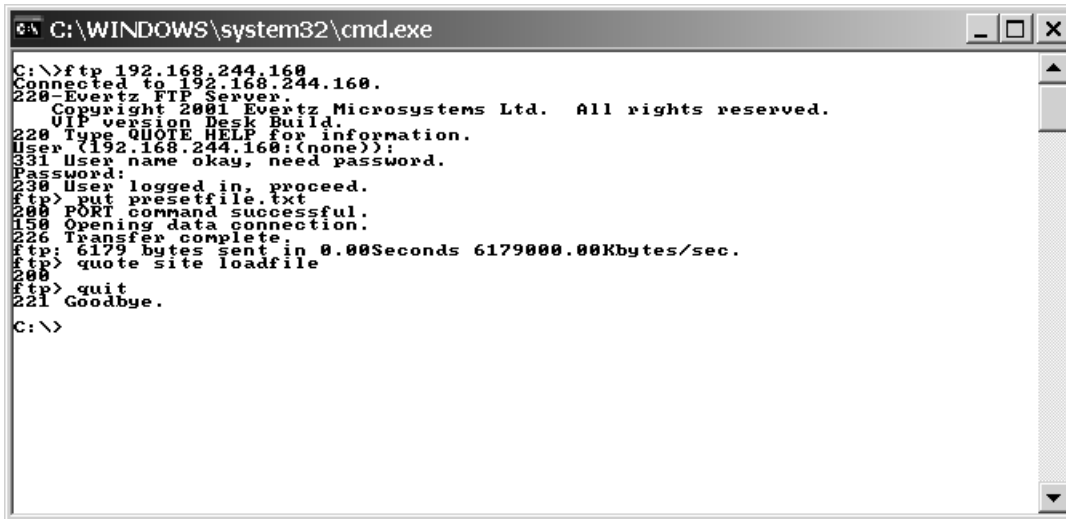

```

C:\WINDOWS\system32\cmd.exe
C:\>ftp 192.168.244.160
Connected to 192.168.244.160.
220 Evertz FTP Server.
    Copyright 2001 Evertz Microsystems Ltd. All rights reserved.
    VIP version Desk Build.
220 Type QUOTE HELP for information.
User (192.168.244.160:(none)):
331 User name okay, need password.
password:
230 User logged in, proceed.
ftp> put presetfile.txt
200 PORT command successful.
150 Opening data connection.
226 Transfer complete.
ftp: 6179 bytes sent in 0.00Seconds 6179000.00Kbytes/sec.
ftp> quote site loadfile
200
ftp> quit
221 Goodbye.
C:\>

```

5.5. WRITE-PROTECTING THE USER PRESETS

Each of the ten *user preset* memory locations can be locked against accidental overwriting. If the user attempts to store a preset into a locked location the front panel will display the message `Preset n locked`, where *n* is the number of the *user preset*.



Presets that are protected may still be overwritten by uploading a user preset file as described in section 5.4.3.

To lock one of the presets using the integrated front panel or the rack mount remote panel press the **ESC** and **PRESET SAVE** buttons at the same time. The control panel will display `Protect preset #`. Press the **USER PRESET** button corresponding to the location you wish to lock. The control panel display will show `Confirm lock n`. To confirm the locking of this preset press the **PRESET SAVE** button. The control panel will show the message `Preset n locked`. To unlock one of the presets press the **ESC** and **PRESET SAVE** buttons at the same time. The control panel will display `Protect preset #`. Press the **USER PRESET** button corresponding to the location you wish to unlock. The control panel display will show `Confirm unlock n`. To confirm the unlocking of this preset press **PRESET SAVE** button. The control panel will show the message `Preset n unlockd`.

To lock one of the presets using the desktop remote panel, press the **ESC** and **PRESET SAVE** buttons at the same time. The control panel display will show *Protect preset #*. Select the location you wish to lock using the **SHIFT LOCK** and **USER PRESET** buttons. The control panel display will show *Confirm lock n*. To confirm the locking of this preset press the **PRESET SAVE** button. The control panel display will show the message *Preset n locked*. To unlock one of the presets press the **ESC** and **PRESET SAVE** buttons at the same time. The control panel display will show *Protect preset #*. Select the location you wish to unlock using the **SHIFT LOCK** and **USER PRESET** buttons. The control panel display will show *Confirm unlock n*. To confirm the unlocking of this preset press the **PRESET SAVE** button. The control panel display will show the message *Preset n unlockd*.

5.6. RESTORING THE GRATICULE GENERATOR TO ITS FACTORY DEFAULTS

The HD9690 can be restored to its factory default condition using the following procedure.



All menu settings and user presets will be over written by this process. Proceed with caution.

To reset the Graticule generator to its factory defaults using the integrated front panel or the rack mount remote panel press and hold the **USER PRESET 9** button and then press the **KEYER ON/OFF** button at the same time. To reset the Graticule generator to its factory defaults using the desktop remote panel press and hold the **AUTO ASPECT** button and then press the **ESC** button at the same time. The control panel will display *Clear presets?* To confirm the erasing of user settings press the **PRESET SAVE** button. The control panel will show the message *clearing presets* while the user settings are being erased. The HD9690 will go through a reboot cycle to load the factory defaults into the unit.

This page left intentionally blank

CHAPTER 6: VIDEO STANDARD RASTER DEFINITIONS**TABLE OF CONTENTS**

6. VIDEO STANDARD RASTER DEFINITIONS	6-1
6.1. HIGH DEFINITION VIDEO FORMAT SUMMARY	6-1
6.1.1. Interlaced and Segmented Frame HD formats: 1080I, 1035I, 1080PsF	6-1
6.1.2. Progressive HD formats: 1080P, 720P	6-2
6.1.3. Digital Cinema HD formats: 2048x1080PsF	6-3
6.2. PRODUCTION AND CLEAN APERTURES	6-3

Figures

Figure 6-1: High Definition Interlaced/Segmented Frame Video Format Parameters.....	6-1
Figure 6-2: High Definition Progressive Video Format Parameters.....	6-2
Figure 6-3: Digital Cinema Video Format Parameters	6-3

This page left intentionally blank

6. VIDEO STANDARD RASTER DEFINITIONS

6.1. HIGH DEFINITION VIDEO FORMAT SUMMARY

The HD9690 Graticule Generator supports SMPTE ST 292-1 and Dual Link SMPTE ST 372 format video in the 1035i/60, 1080i/60, 1080i/50, 1080p/24, 1080p/24sF, 2048x1080p/24sF and 720p/60 formats.

6.1.1. Interlaced and Segmented Frame HD formats: 1080I, 1035I, 1080PsF

SMPTE 260M and SMPTE 274M define the following video format characteristics:

	1035I	1080I	1080PsF
Total Raster:	Interlaced 2:1	Interlaced 2:1	Progressive Segmented 2:1
Lines Field (segment) 1	1 to 563	1 to 563	1 to 563
Field (segment) 2	564 to 1125	564 to 1125	564 to 1125
Pixels 30(29.97) FPS	2200 (0 to 2199)	2200 (0 to 2199)	2200 (0 to 2199)
25 FPS		2640 (0 to 2199)	2640 (0 to 2639)
24 (23.976) FPS			2750 (0 to 2749)
Production Aperture:			
Aspect Ratio	16:9	16:9	16:9
Size (pixels x lines)	1920 x 1035	1920 x 1080	1920 x 1080
Vertical Extent Field 1	41 to 557	21 to 560	21 to 560
Field 2	603 to 1120	584 to 1123	584 to 1123
Horizontal Extent	0 to 1919	0 to 1919	0 to 1919
Clean Aperture			
Size (pixels x lines)	1888 x 1017	1888 x 1062	1888 x 1062
Vertical Extent Field 1	50 to 548	25 to 556	25 to 556
Field 2	612 to 1111	588 to 1119	588 to 1119
Horizontal Extent	16 to 1903	16 to 1903	16 to 1903
Center of Image			
Horizontal midway between pixels	959 and 960	959 and 960	959 and 960
Vertical midway between lines	861 field 2 299 field 1	844 field 2 270 field 1	844 (segment 2) 270 (segment 1)
Pixel Aspect Ratio			
Standard	Approx 1.0434:1	1:1	1:1
Safe Area Dimensions (standard Practice)			
Safe Action	90 %	90%	90%
Safe Title	80 %	80 %	80 %

Figure 6-1: High Definition Interlaced/Segmented Frame Video Format Parameters

6.1.2. Progressive HD formats: 1080P, 720P

SMPTE 274M and SMPTE 296M define the following progressive video format characteristics:

	1080P	720P
Total Raster:	Progressive	Progressive
Lines	1125	750
Pixels 60(29.97) FPS	2200 (0 to 2199) *	1650 (0 to 1649)
50 FPS	2640 (0 to 2639) *	1980 (0 to 1979)
30(29.97) FPS	2200 (0 to 2199)	3300 (0 to 3299) *
25 FPS	2640 (0 to 2639)	3960 (0 to 3959) *
24 (23.976) FPS	2750 (0 to 2749)	4125 (0 to 4124) *
Production Aperture:		
Size (pixels x lines)	1920 x 1080	1280 x 720
Vertical Extent	42 to 1121	26 to 745
Horizontal Extent	0 to 1919	0 to 1279
Clean Aperture		
Size (pixels x lines)	1888 x 1062	1248 x 702
Vertical Extent	51 to 1112	35 to 736
Horizontal Extent	16 to 1903	16 to 1263
Center of Image		
Horizontal midway between pixels	959 and 960	639 and 640
Vertical midway between lines	581 582	385 386
Pixel Aspect Ratio		
Standard (16:9)	1:1	1:1
Safe Area Dimensions (standard Practice)		
Safe Action	90 %	90%
Safe Title	80 %	80 %

* Video format not supported by HD9690

Figure 6-2: High Definition Progressive Video Format Parameters

6.1.3. Digital Cinema HD formats: 2048x1080PsF

SMPTE 428M defines the following video format characteristics:

		2048x1080PsF
Total Raster:		Progressive Segmented 2:1
Lines	Segment 1	1 to 563
	Segment 2	564 to 1125
Pixels	24 (23.976) FPS	2750 (0 to 2749)
Production Aperture:		
Aspect Ratio		Approx 1.897:1
Size (pixels x lines)		2048 x 1080
Vertical Extent	Field 1	21 to 560
	Field 2	584 to 1123
Horizontal Extent		0 to 2047
Clean Aperture		
Size (pixels x lines)		2014 x 1062
Vertical Extent	Field 1	25 to 556
	Field 2	588 to 1119
Horizontal Extent		17 to 2030
Center of Image		
Horizontal midway between pixels		1023 and 1024
Vertical midway between lines		844 (segment 2) 270 (segment 1)
Pixel Aspect Ratio		
Standard		1:1
Safe Area Dimensions (standard Practice)		
Safe Action		90%
Safe Title		80 %

Figure 6-3: Digital Cinema Video Format Parameters

6.2. PRODUCTION AND CLEAN APERTURES

The production aperture as defined above is the maximum possible image area that can be supported by the video standard. The clean aperture is a slightly smaller image area of similar, but not necessarily exactly the same aspect ratio and is usually concentric with the production aperture.

This page left intentionally blank

CHAPTER 7: FACTORY PRESETS

TABLE OF CONTENTS

7. FACTORY PRESETS	7-1
7.1. CURRENT SAFE AREAS SPECIFIED IN SMPTE ST 2046-1-2009	7-1
7.1.1. ALL OBJECT RESET	7-1
7.1.2. CLEAN APERTURE PRESETS	7-1
7.1.2.1. 16:9 SA/ST CA.....	7-1
7.1.2.2. 4:3 SA/ST CA	7-2
7.1.2.3. 14:9 SA/ST CA.....	7-2
7.1.2.4. 1.66 MASK CA.....	7-2
7.1.2.5. 1.85 MASK CA.....	7-3
7.1.2.6. 2.35 MASK CA.....	7-3
7.1.3. PRODUCTION APERTURE PRESETS.....	7-3
7.1.3.1. 16:9 SA/ST PA.....	7-3
7.1.3.2. 4:3 SA/ST PA.....	7-4
7.1.3.3. 14:9 SA/ST PA.....	7-4
7.1.3.4. 1.66 MASK PA.....	7-4
7.1.3.5. 1.85 MASK PA.....	7-5
7.1.3.6. 2.35 MASK PA.....	7-5
7.2. LEGACY SAFE AREAS SPECIFIED IN SMPTE RP218	7-5
7.2.1. ALL OBJECT RESET	7-5
7.2.2. CLEAN APERTURE PRESETS	7-5
7.2.2.1. 16:9 SA/ST CA.....	7-5
7.2.2.2. 4:3 SA/ST CA	7-6
7.2.2.3. 14:9 SA/ST CA.....	7-6
7.2.2.4. 1.66 MASK CA.....	7-7
7.2.2.5. 1.85 MASK CA.....	7-7
7.2.2.6. 2.35 MASK CA.....	7-7
7.2.3. PRODUCTION APERTURE PRESETS.....	7-8
7.2.3.1. 16:9 SA/ST PA.....	7-8
7.2.3.2. 4:3 SA/ST PA.....	7-8
7.2.3.3. 14:9 SA/ST PA.....	7-8
7.2.3.4. 1.66 MASK PA.....	7-9
7.2.3.5. 1.85 MASK PA.....	7-9
7.2.3.6. 2.35 MASK PA.....	7-9

This page left intentionally blank

7. FACTORY PRESETS

The *factory presets* available at the time of printing are shown below. In the front panel descriptions of the *factory presets* CA refers to clean aperture, PA refers to production aperture.

SMPTE has recently published a new safe area specification in SMPTE ST 2046-1 based on fixed pixel matrix displays and are significantly larger than previously specified in RP218, The safe areas specified in RP218 are a legacy of past practice and are based on the limitations of CRT-based displays. In order to accommodate both of these specifications, use the *Safe Area* item on the *Setup Menu* to select which group of factory presets will be used.

The HD9690 uses the same set of factory presets with the same description for all video standards. The following preset names and descriptions are identical in each mode, however video standard has its own set of factory presets as the vertical and horizontal positions of the clean and production apertures are different. See the charts in section A.2 for a complete description of the size of the clean and production apertures for each video format.

7.1. CURRENT SAFE AREAS SPECIFIED IN SMPTE ST 2046-1-2009

7.1.1. ALL OBJECT RESET

All objects are off. Objects are positioned the same as 16x9 SA/ST PA preset.

Object	On	V Pos	H Pos	Aspect Ratio	Comments
Grid		CA	4:3 from CA		
Mask		CA	CA		
Box1		93 % of CA	93 % of CA		Safe Action
Box2		90 % of CA	90 % of CA		Safe Title
Cursor1		Centre	Centre		
Cursor2		Centre	Centre		
Ellipse		Same as Box 2	1:1 from V Pos		

7.1.2. CLEAN APERTURE PRESETS

7.1.2.1. 16:9 SA/ST CA

16:9 aspect ratio safe area and safe title boxes are set to 93% and 90% of clean aperture. Centre cursor is turned on. Mask and grid set at clean aperture but mask turned off.

Object	On	V Pos	H Pos	Aspect Ratio	Comments
Grid	√	CA	4:3 from CA		
Mask		CA	CA	16:9	
Box1	√	93 % of CA	93 % of CA	16:9	Safe Action
Box2	√	90 % of CA	90 % of CA	16:9	Safe Title
Cursor1	√	Centre	Centre		
Cursor2		Centre	Centre		
Ellipse		80 % of CA		1:1	

7.1.2.2. 4:3 SA/ST CA

4:3 aspect ratio safe area and safe title box heights are set to 93% and 90% of clean aperture. Centre cursor is turned on. 4:3 Mask set at clean aperture but turned Off. Grid set to show 4:3 width from clean aperture.

Object	On	V Pos	H Pos	Aspect Ratio	Comments
Grid	√	CA	4:3 from CA		
Mask		CA	4:3 from CA	4:3	
Box1	√	93 % of CA		4:3	Safe Action
Box2	√	90 % of CA		4:3	Safe Title
Cursor1	√	Centre	Centre		
Cursor2		Centre	Centre		
Ellipse		Same as Box 2		1:1	

7.1.2.3. 14:9 SA/ST CA

14:9 aspect ratio safe area and safe title box heights are set to 93% and 90% of clean aperture. Centre cursor is turned on. 14:9 Mask set at production aperture but turned Off. Grid set to show 14:9 width from production aperture.

Object	On	V Pos	H Pos	Aspect Ratio	Comments
Grid	√	CA	14:9 from CA		
Mask		CA	14:9 from CA	14:9	
Box1	√	93 % of CA		14:9	Safe Action
Box2	√	90 % of CA		14:9	Safe Title
Cursor1	√	Centre	Centre		
Cursor2		Centre	Centre		
Ellipse		Same as Box 2		1:1	

7.1.2.4. 1.66 MASK CA

1.66 mask calculated from clean aperture. 14:9 aspect ratio safe area and safe title box heights are set to 93% and 90% of clean aperture but turned off.

Object	On	V Pos	H Pos	Aspect Ratio	Comments
Grid		CA	1.66:1 from CA		
Mask	√	CA	1.66:1 from CA	1.66:1	
Box1		93 % of CA		1.66:1	Safe Action
Box2		90 % of CA		1.66:1	Safe Title
Cursor1		Centre	Centre		
Cursor2		Centre	Centre		
Ellipse		Same as Box 2		1:1	

7.1.2.5. 1.85 MASK CA

1.85 mask calculated from clean aperture. 1.85 aspect ratio safe area and safe title box widths are set to 93% and 90% of clean aperture but turned off.

Object	On	V Pos	H Pos	Aspect Ratio	Comments
Grid		1.85:1 from CA	CA		
Mask	√	1.85:1 from CA	CA	1.85:1	
Box1			93 % of CA	1.85:1	Safe Action
Box2			90 % of CA	1.85:1	Safe Title
Cursor1		Centre	Centre		
Cursor2		Centre	Centre		
Ellipse		Same as Box 2		1:1	

7.1.2.6. 2.35 MASK CA

2.35 mask calculated from clean aperture. 2.35 aspect ratio safe area and safe title box widths are set to 93% and 90% of clean aperture but turned off.

Object	On	V Pos	H Pos	Aspect Ratio	Comments
Grid		2.35:1 from CA	CA		
Mask	√	2.35:1 from CA	CA	2.35:1	
Box1			93 % of CA	2.35:1	Safe Action
Box2			90 % of CA	2.35:1	Safe Title
Cursor1		Centre	Centre		
Cursor2		Centre	Centre		
Ellipse		Same as Box 2		1:1	

7.1.3. PRODUCTION APERTURE PRESETS
7.1.3.1. 16:9 SA/ST PA

16:9 aspect ratio safe area and safe title boxes are set to 93% and 90% of clean aperture. Centre cursor is turned on. Mask and grid set at production aperture but mask turned off.

Object	On	V Pos	H Pos	Aspect Ratio	Comments
Grid	√	PA	4:3 from PA		
Mask		PA	PA	16:9	
Box1	√	93 % of PA	93 % of PA	16:9	Safe Action
Box2	√	90 % of PA	90 % of PA	16:9	Safe Title
Cursor1	√	Centre	Centre		
Cursor2		Centre	Centre		
Ellipse		Same as Box 2		1:1	

7.1.3.2. 4:3 SA/ST PA

4:3 aspect ratio safe area and safe title box heights are set to 93% and 90% of production aperture. Centre cursor is turned on. 4:3 Mask set at production aperture but turned Off. Grid set to show 4:3 width from production aperture.

Object	On	V Pos	H Pos	Aspect Ratio	Comments
Grid	√	PA	4:3 from PA		
Mask		PA	4:3 from PA	4:3	
Box1	√	93 % of PA		4:3	Safe Action
Box2	√	90 % of PA		4:3	Safe Title
Cursor1	√	Centre	Centre		
Cursor2		Centre	Centre		
Ellipse		Same as Box 2		1:1	

7.1.3.3. 14:9 SA/ST PA

14:9 aspect ratio safe area and safe title box heights are set to 93% and 90% of production aperture. Centre cursor is turned on. 14:9 Mask set at production aperture but turned Off. Grid set to show 14:9 width from production aperture.

Object	On	V Pos	H Pos	Aspect Ratio	Comments
Grid	√	PA	14:9 from PA		
Mask		PA	14:9 from PA	14:9	
Box1	√	93 % of PA		14:9	Safe Action
Box2	√	90 % of PA		14:9	Safe Title
Cursor1	√	Centre	Centre		
Cursor2		Centre	Centre		
Ellipse		Same as Box 2		1:1	

7.1.3.4. 1.66 MASK PA

1.66 mask calculated from production aperture. 14:9 aspect ratio safe area and safe title box heights are set to 93% and 90% of production aperture but turned off.

Object	On	V Pos	H Pos	Aspect Ratio	Comments
Grid		PA	1.66:1 from PA		
Mask	√	PA	1.66:1 from PA	1.66:1	
Box1		93 % of PA		1.66:1	Safe Action
Box2		90 % of PA		1.66:1	Safe Title
Cursor1		Centre	Centre		
Cursor2		Centre	Centre		
Ellipse		Same as Box 2		1:1	

7.1.3.5. 1.85 MASK PA

1.85 mask calculated from production aperture. 1.85 aspect ratio safe area and safe title box widths are set to 93% and 90% of production aperture but turned off.

Object	On	V Pos	H Pos	Aspect Ratio	Comments
Grid		1.85:1 from PA	PA		
Mask	√	1.85:1 from PA	PA	1.85:1	
Box1			93 % of PA	1.85:1	Safe Action
Box2			90 % of PA	1.85:1	Safe Title
Cursor1		Centre	Centre		
Cursor2		Centre	Centre		
Ellipse		Same as Box 2		1:1	

7.1.3.6. 2.35 MASK PA

2.35 mask calculated from production aperture. 2.35 aspect ratio safe area and safe title box widths are set to 93% and 90% of production aperture but turned off.

Object	On	V Pos	H Pos	Aspect Ratio	Comments
Grid		2.35:1 from PA	PA		
Mask	√	2.35:1 from PA	PA	2.35:1	
Box1			93 % of PA	2.35:1	Safe Action
Box2			90 % of PA	2.35:1	Safe Title
Cursor1		Centre	Centre		
Cursor2		Centre	Centre		
Ellipse		Same as Box 2		1:1	

7.2. LEGACY SAFE AREAS SPECIFIED IN SMPTE RP218
7.2.1. ALL OBJECT RESET

All objects are off. Objects are positioned the same as 16x9 SA/ST CA preset.

Object	On	V Pos	H Pos	Aspect Ratio	Comments
Grid		CA	4:3 from CA		
Mask		CA	CA		
Box1		90 % of CA	90 % of CA		Safe Action
Box2		80 % of CA	80 % of CA		Safe Title
Cursor1		Centre	Centre		
Cursor2		Centre	Centre		
Ellipse		Same as Box 2	1:1 from V Pos		

7.2.2. CLEAN APERTURE PRESETS
7.2.2.1. 16:9 SA/ST CA

16:9 aspect ratio safe area and safe title boxes are set to 90% and 80% of clean aperture. Centre cursor is turned on. Mask and grid set at clean aperture but mask turned off.

Object	On	V Pos	H Pos	Aspect Ratio	Comments
Grid	√	CA	4:3 from CA		
Mask		CA	CA	16:9	
Box1	√	90 % of CA	90 % of CA	16:9	Safe Action
Box2	√	80 % of CA	80 % of CA	16:9	Safe Title
Cursor1	√	Centre	Centre		
Cursor2		Centre	Centre		
Ellipse		80 % of CA		1:1	

7.2.2.2. 4:3 SA/ST CA

4:3 aspect ratio safe area and safe title box heights are set to 90% and 80% of clean aperture. Centre cursor is turned on. 4:3 Mask set at clean aperture but turned Off. Grid set to show 4:3 width from clean aperture.

Object	On	V Pos	H Pos	Aspect Ratio	Comments
Grid	√	CA	4:3 from CA		
Mask		CA	4:3 from CA	4:3	
Box1	√	90 % of CA		4:3	Safe Action
Box2	√	80 % of CA		4:3	Safe Title
Cursor1	√	Centre	Centre		
Cursor2		Centre	Centre		
Ellipse		Same as Box 2		1:1	

7.2.2.3. 14:9 SA/ST CA

14:9 aspect ratio safe area and safe title box heights are set to 90% and 80% of clean aperture. Centre cursor is turned on. 14:9 Mask set at production aperture but turned Off. Grid set to show 14:9 width from production aperture.

Object	On	V Pos	H Pos	Aspect Ratio	Comments
Grid	√	CA	14:9 from CA		
Mask		CA	14:9 from CA	14:9	
Box1	√	90 % of CA		14:9	Safe Action
Box2	√	80 % of CA		14:9	Safe Title
Cursor1	√	Centre	Centre		
Cursor2		Centre	Centre		
Ellipse		Same as Box 2		1:1	

7.2.2.4. 1.66 MASK CA

1.66 mask calculated from clean aperture. 14:9 aspect ratio safe area and safe title box heights are set to 90% and 80% of clean aperture but turned off.

Object	On	V Pos	H Pos	Aspect Ratio	Comments
Grid		CA	1.66:1 from CA		
Mask	√	CA	1.66:1 from CA	1.66:1	
Box1		90 % of CA		1.66:1	Safe Action
Box2		80 % of CA		1.66:1	Safe Title
Cursor1		Centre	Centre		
Cursor2		Centre	Centre		
Ellipse		Same as Box 2		1:1	

7.2.2.5. 1.85 MASK CA

1.85 mask calculated from clean aperture. 1.85 aspect ratio safe area and safe title box widths are set to 90% and 80% of clean aperture but turned off.

Object	On	V Pos	H Pos	Aspect Ratio	Comments
Grid		1.85:1 from CA	CA		
Mask	√	1.85:1 from CA	CA	1.85:1	
Box1			90 % of CA	1.85:1	Safe Action
Box2			80 % of CA	1.85:1	Safe Title
Cursor1		Centre	Centre		
Cursor2		Centre	Centre		
Ellipse		Same as Box 2		1:1	

7.2.2.6. 2.35 MASK CA

2.35 mask calculated from clean aperture. 2.35 aspect ratio safe area and safe title box widths are set to 90% and 80% of clean aperture but turned off.

Object	On	V Pos	H Pos	Aspect Ratio	Comments
Grid		2.35:1 from CA	CA		
Mask	√	2.35:1 from CA	CA	2.35:1	
Box1			90 % of CA	2.35:1	Safe Action
Box2			80 % of CA	2.35:1	Safe Title
Cursor1		Centre	Centre		
Cursor2		Centre	Centre		
Ellipse		Same as Box 2		1:1	

7.2.3. PRODUCTION APERTURE PRESETS

7.2.3.1. 16:9 SA/ST PA

16:9 aspect ratio safe area and safe title boxes are set to 90% and 80% of clean aperture. Centre cursor is turned on. Mask and grid set at production aperture but mask turned off.

Object	On	V Pos	H Pos	Aspect Ratio	Comments
Grid	√	PA	4:3 from PA		
Mask		PA	PA	16:9	
Box1	√	90 % of PA	90 % of PA	16:9	Safe Action
Box2	√	80 % of PA	80 % of PA	16:9	Safe Title
Cursor1	√	Centre	Centre		
Cursor2		Centre	Centre		
Ellipse		Same as Box 2		1:1	

7.2.3.2. 4:3 SA/ST PA

4:3 aspect ratio safe area and safe title box heights are set to 90% and 80% of production aperture. Centre cursor is turned on. 4:3 Mask set at production aperture but turned Off. Grid set to show 4:3 width from production aperture.

Object	On	V Pos	H Pos	Aspect Ratio	Comments
Grid	√	PA	4:3 from PA		
Mask		PA	4:3 from PA	4:3	
Box1	√	90 % of PA		4:3	Safe Action
Box2	√	80 % of PA		4:3	Safe Title
Cursor1	√	Centre	Centre		
Cursor2		Centre	Centre		
Ellipse		Same as Box 2		1:1	

7.2.3.3. 14:9 SA/ST PA

14:9 aspect ratio safe area and safe title box heights are set to 90% and 80% of production aperture. Centre cursor is turned on. 14:9 Mask set at production aperture but turned Off. Grid set to show 14:9 width from production aperture.

Object	On	V Pos	H Pos	Aspect Ratio	Comments
Grid	√	PA	14:9 from PA		
Mask		PA	14:9 from PA	14:9	
Box1	√	90 % of PA		14:9	Safe Action
Box2	√	80 % of PA		14:9	Safe Title
Cursor1	√	Centre	Centre		
Cursor2		Centre	Centre		
Ellipse		Same as Box 2		1:1	

7.2.3.4. 1.66 MASK PA

1.66 mask calculated from production aperture. 14:9 aspect ratio safe area and safe title box heights are set to 90% and 80% of production aperture but turned off.

Object	On	V Pos	H Pos	Aspect Ratio	Comments
Grid		PA	1.66:1 from PA		
Mask	√	PA	1.66:1 from PA	1.66:1	
Box1		90 % of PA		1.66:1	Safe Action
Box2		80 % of PA		1.66:1	Safe Title
Cursor1		Centre	Centre		
Cursor2		Centre	Centre		
Ellipse		Same as Box 2		1:1	

7.2.3.5. 1.85 MASK PA

1.85 mask calculated from production aperture. 1.85 aspect ratio safe area and safe title box widths are set to 90% and 80% of production aperture but turned off.

Object	On	V Pos	H Pos	Aspect Ratio	Comments
Grid		1.85:1 from PA	PA		
Mask	√	1.85:1 from PA	PA	1.85:1	
Box1			90 % of PA	1.85:1	Safe Action
Box2			80 % of PA	1.85:1	Safe Title
Cursor1		Centre	Centre		
Cursor2		Centre	Centre		
Ellipse		Same as Box 2		1:1	

7.2.3.6. 2.35 MASK PA

2.35 mask calculated from production aperture. 2.35 aspect ratio safe area and safe title box widths are set to 90% and 80% of production aperture but turned off.

Object	On	V Pos	H Pos	Aspect Ratio	Comments
Grid		2.35:1 from PA	PA		
Mask	√	2.35:1 from PA	PA	2.35:1	
Box1			90 % of PA	2.35:1	Safe Action
Box2			80 % of PA	2.35:1	Safe Title
Cursor1		Centre	Centre		
Cursor2		Centre	Centre		
Ellipse		Same as Box 2		1:1	

This page left intentionally blank

CHAPTER 8: SAFE AREA OPERATIONAL PRACTICES**TABLE OF CONTENTS**

8. SAFE AREA OPERATIONAL PRACTICES	8-1
8.1. FREE TV AUSTRALIA OPERATION PRACTICE OP-36	8-1
8.1.1. HDTV – SAFE ACTION AND SAFE GRAPHIC AREAS	8-1
8.2. 720P OPERATIONAL PRACTICE.....	8-3

Figures

Figure 8-1: Australian 1080i 16:9 HD transmission Safe Areas	8-2
Figure 8-2: Australian 16:9 Shoot and Protect 4:3 Safe Areas for SD Analog Transmission.....	8-2
Figure 8-3: Australian 16:9 Shoot and Protect 14:9 Safe Areas for SD Analog Transmission.....	8-3
Figure 8-4: 720p 16:9 HD Transmission Safe Areas.....	8-4

This page left intentionally blank

8. SAFE AREA OPERATIONAL PRACTICES

The following sections summarize some of the recommended practices for defining safe action and safe title areas in use throughout the world. This information is provided to guide the user in setting up the correct graticule sizes for their application.



The information provided is current at the time of writing and may have been updated by the respective standards body. The user is advised to obtain the current version of the document from which this information was obtained.

8.1. FREE TV AUSTRALIA OPERATION PRACTICE OP-36

This Operational Practice recommends the format and quality of video and audio associated with the videotape delivery of SDTV and HDTV commercials to the Australian Terrestrial Broadcast Industry. Its reference is to product of both film and video camera origin. The information provided in this section is taken from Appendix B of the document

8.1.1. HDTV – SAFE ACTION AND SAFE GRAPHIC AREAS

The recommended HDTV ‘Safe Action’ and ‘Safe Graphic’ areas are defined by the following three diagrams.

Diagram 1 is the HD transmission situation, 16:9 Shoot Protect 16:9, with a line length of 1920 pixels. The safe areas are calculated to this base. This will not be the normal situation for some time to come.

Diagrams 2 and 3 represent the situation where the HD signal has been down-converted to SD for a 4:3 simulcast service. The SD 4:3 service will involve some form of analog interface where the wide line blanking used produces an active line of 702 pixels. This means that in the HD signal only the central 1872 pixels would be effectively used in the downconverted signal.

Diagram 2 is 16:9 Shoot Protect 4:3. The line length base for calculating Safe Areas is 1872 pixels

Diagram 3 is 16:9 Shoot Protect 14:9. The line base for calculating Safe Area is 1872 pixels. The Safe Action Area is 14:9 but the Safe Graphics Area has been retained as per the 4:3 central zone. This is to accommodate STBs which may produce a 4:3 centre cut when driving a 4:3 display.

The overscan of domestic displays is assumed to be 7% of overall picture width or height (i.e. 3.5% at each edge) but any one picture edge should not exceed 4% of total picture width or height.

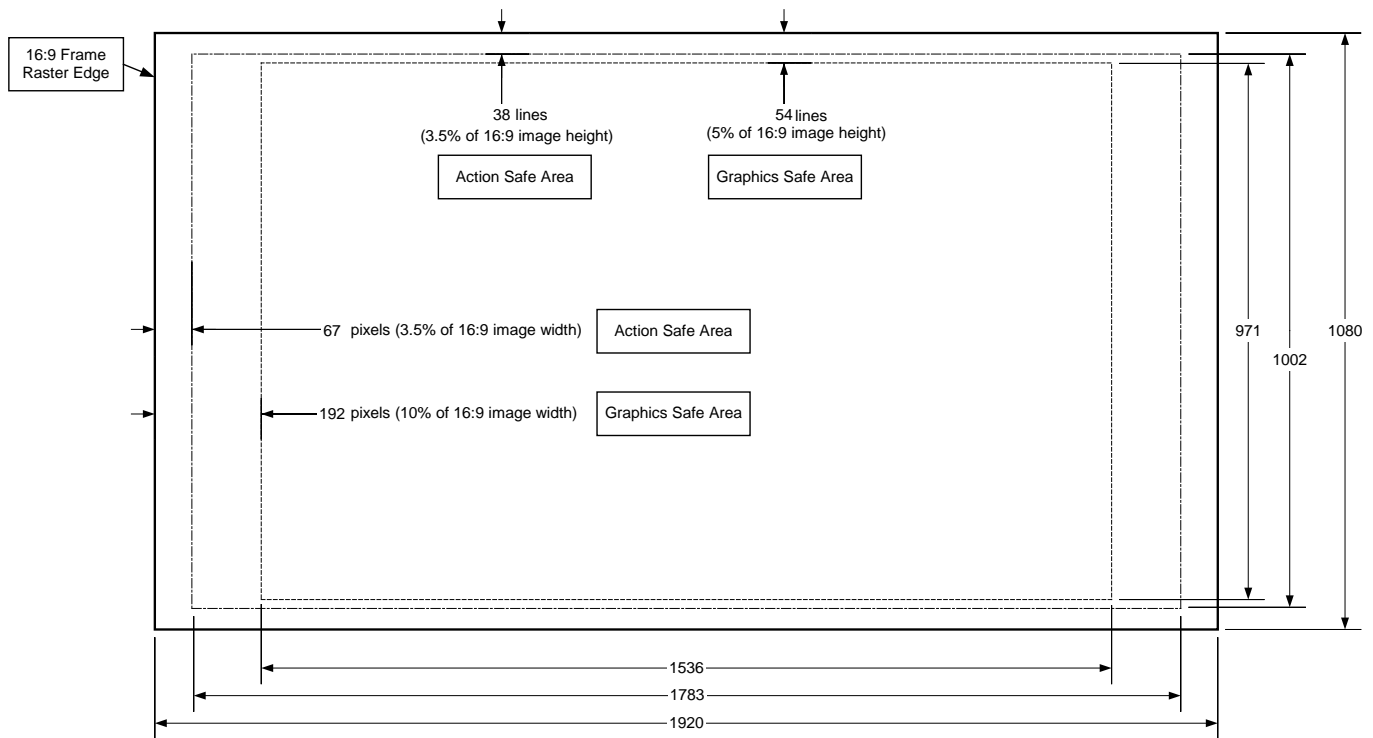

Figure 8-1: Australian 1080i 16:9 HD transmission Safe Areas

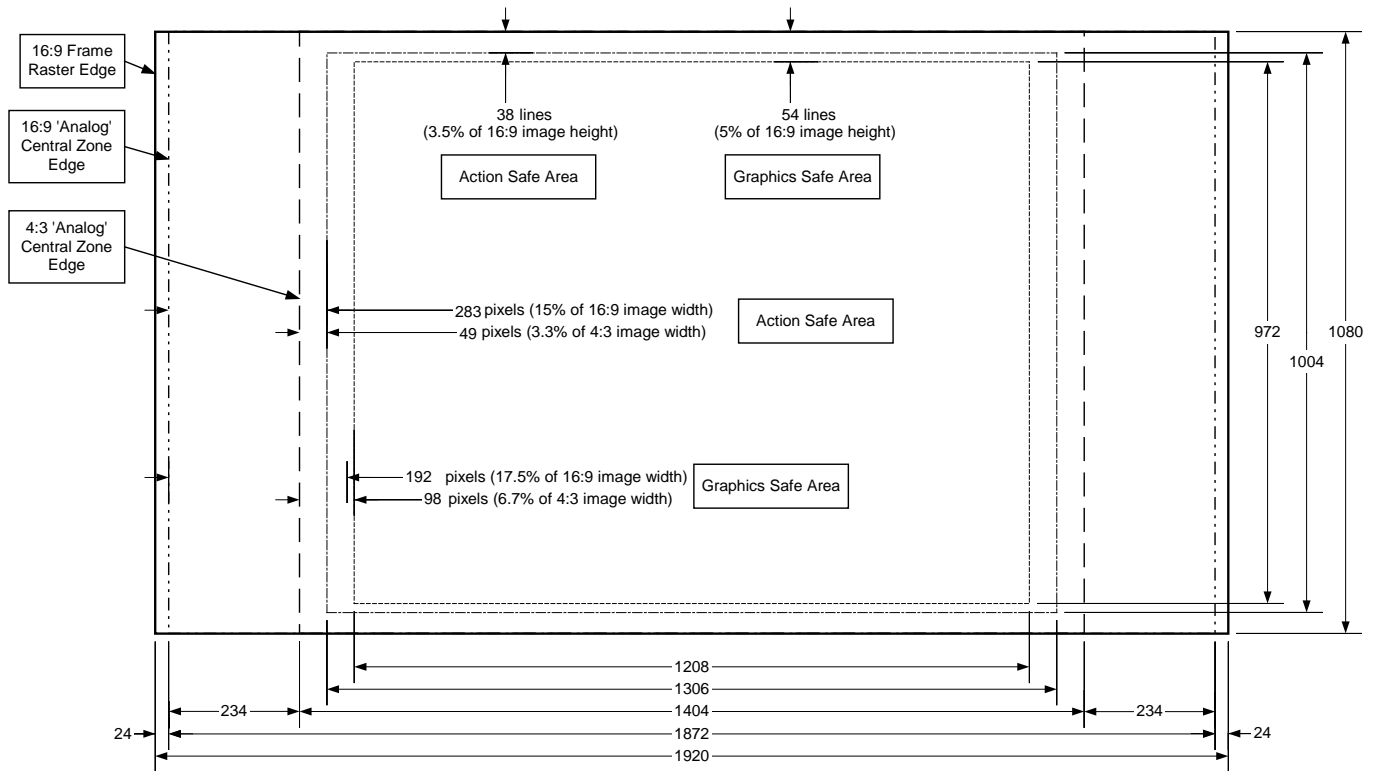

Figure 8-2: Australian 16:9 Shoot and Protect 4:3 Safe Areas for SD Analog Transmission

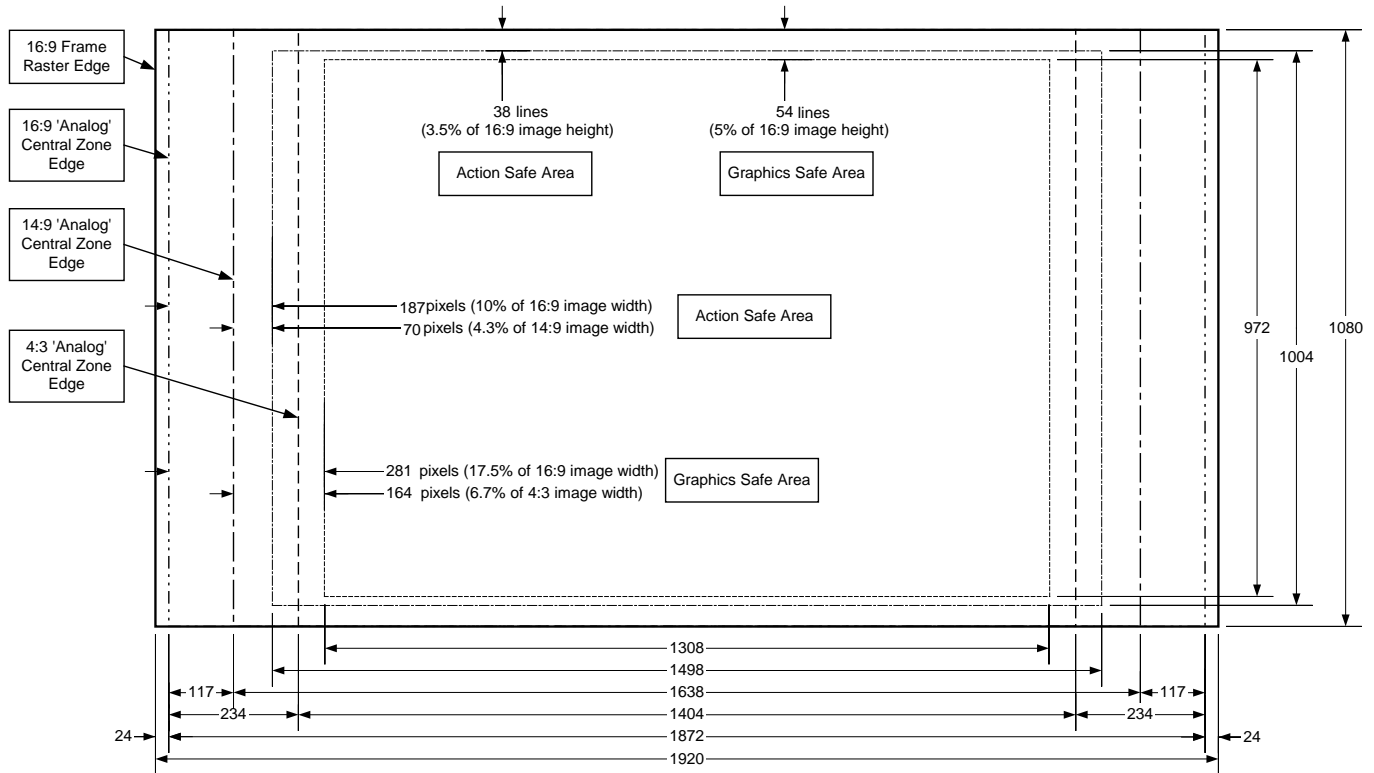

Figure 8-3: Australian 16:9 Shoot and Protect 14:9 Safe Areas for SD Analog Transmission

8.2. 720P OPERATIONAL PRACTICE

This Operational Practice recommends the format and quality of video and audio associated with the videotape delivery of 1280 x 720 Progressive scan HDTV and is used by at least one of the USA Television Broadcasters.

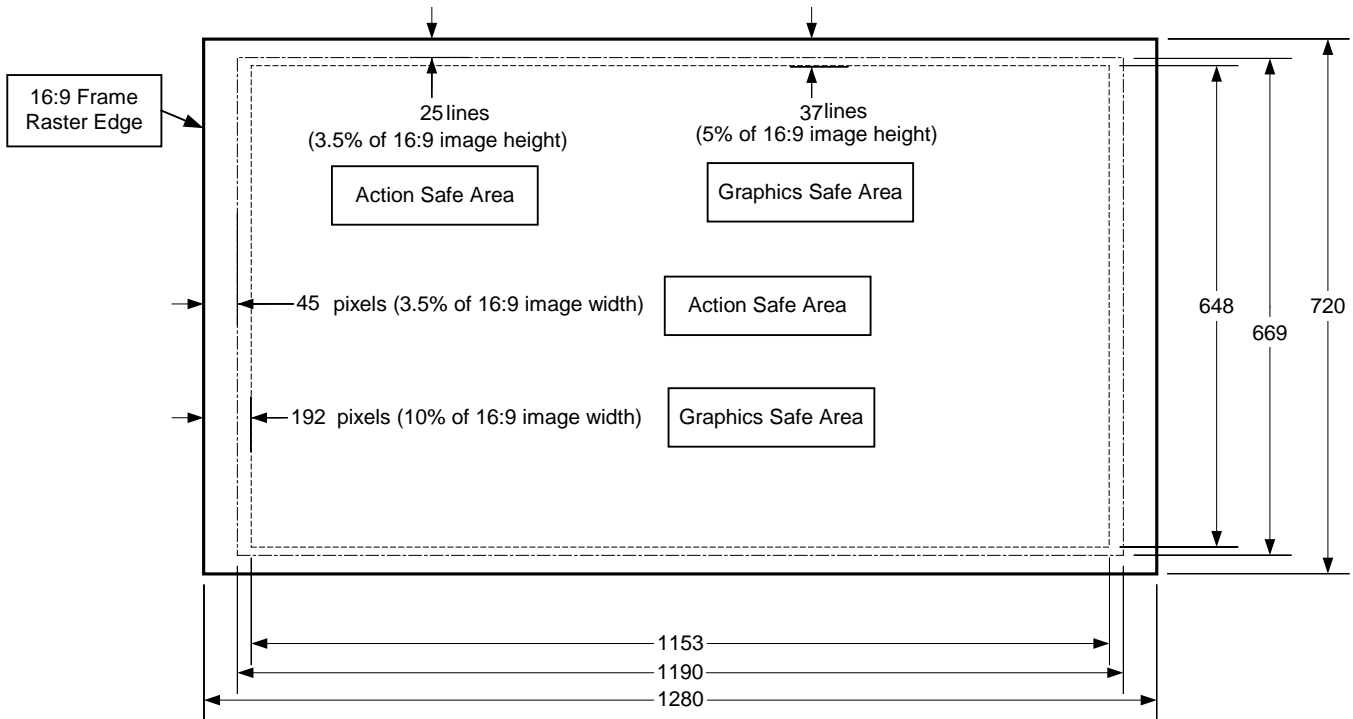

Figure 8-4: 720p 16:9 HD Transmission Safe Areas