



3Mb to 3Gb Digital Video Routing USER MANUAL

© Copyright 2007 - 2017

EVERTZ MICROSYSTEMS LTD.

5292 John Lucas Drive
Burlington, Ontario
Canada,
L7L 5Z9

Phone: +1 905-335-3700
Sales Fax: +1 905-335-3573
Tech Support Phone: +1 905-335-7570
Tech Support Fax: +1 905-335-7571

Internet:

Sales: sales@evertz.com
Tech Support: service@Moevertz.com
Web Page: <http://www.evertz.com>



Version 3.1, February 2017

The material contained in this manual consists of information that is the property of Evertz Microsystems and is intended solely for the use of purchasers of the EQX Routers. Evertz Microsystems expressly prohibits the use of this manual for any purpose other than the operation of the Routers.

All rights reserved. No part of this publication may be reproduced without the express written permission of Evertz Microsystems Ltd. Copies of this guide can be ordered from your Evertz products dealer or from Evertz Microsystems.

This page left intentionally blank

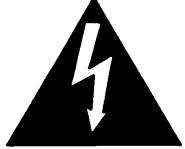
IMPORTANT SAFETY INSTRUCTIONS

	The lightning flash with arrowhead symbol within an equilateral triangle is intended to alert the user to the presence of un-insulated “Dangerous voltage” within the product’s enclosure that may be of sufficient magnitude to constitute a risk of electric shock to persons.
	The exclamation point within an equilateral triangle is intended to alert the user to the presence of important operating and maintenance (Servicing) instructions in the literature accompanying the product.

- Read these instructions
- Keep these instructions.
- Heed all warnings.
- Follow all instructions.
- Do not use this apparatus near water
- Clean only with a dry cloth.
- Do not block any ventilation openings. Install in accordance with the manufacturer’s instructions.
- Do not install near any heat sources such as radiators, heat registers, stoves, or other apparatus (including amplifiers) that produce heat.
- Do not defeat the safety purpose of the polarized or grounding-type plug. A polarized plug has two blades with one wider than other. A grounding-type plug has two blades and a third grounding prong. The wide blade or the third prong is provided for your safety. If the provided plug does not fit into your outlet, consult an electrician for replacement of the obsolete outlet.
- Protect the power cord from being walked on or pinched particularly at plugs, convenience receptacles and the point where they exit from the apparatus.
- Only use attachments/accessories specified by the manufacturer
- Unplug this apparatus during lightning storms or when unused for long periods of time.
- Refer all servicing to qualified service personnel. Servicing is required when the apparatus has been damaged in any way, such as power-supply cord or plug is damaged, liquid has been spilled or objects have fallen into the apparatus, the apparatus has been exposed to rain or moisture, does not operate normally, or has been dropped.

WARNING

TO REDUCE THE RISK OF FIRE OR ELECTRIC – SHOCK, DO NOT EXPOSE THIS APPARATUS TO RAIN OR MOISTURE

WARNING

DO NOT EXPOSE THIS EQUIPMENT TO DRIPPING OR SPLASHING AND ENSURE THAT NO OBJECTS FILLED WITH LIQUIDS ARE PLACED ON THE EQUIPMENT

WARNING

TO COMPLETELY DISCONNECT THIS EQUIPMENT FROM THE AC MAINS, DISCONNECT THE POWER SUPPLY CORD PLUG FROM THE AC RECEPTACLE

WARNING

THE MAINS PLUG OF THE POWER SUPPLY CORD SHALL REMAIN READILY OPERABLE

INFORMATION TO USERS IN EUROPE

NOTE

This equipment with the CE marking complies with both the EMC Directive (2004/108/EC) and the Low Voltage Directive (2006/95/EC) issued by the Commission of the European Community.

Compliance with these directives implies conformity to the following European standards:

- EN60950 Product Safety
- EN55103-1 Electromagnetic Interference Class A (Emission)
- EN55103-2 Electromagnetic Susceptibility (Immunity)

This equipment has been tested and found to comply with the limits for a Class A digital device, pursuant to the European Union EMC directive. These limits are designed to provide reasonable protection against harmful interference when the equipment is operated in a commercial environment. This equipment generates, uses, and can radiate radio frequency energy and, if not installed and used in accordance with the instruction manual, may cause harmful interference to radio communications. Operation of this equipment in a residential area is likely to cause harmful interference in which case the user will be required to correct the interference at his own expense.

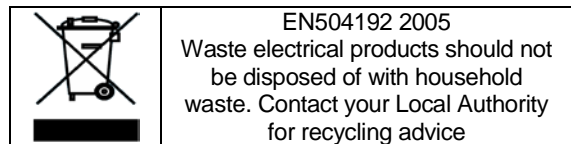
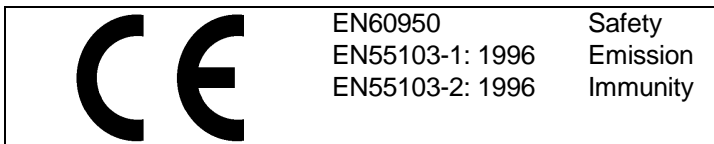

INFORMATION TO USERS IN THE U.S.A.

NOTE

FCC CLASS A DIGITAL DEVICE OR PERIPHERAL

This equipment has been tested and found to comply with the limits for a Class A digital device, pursuant to Part 15 of the FCC Rules. These limits are designed to provide reasonable protection against harmful interference when the equipment is operated in a commercial environment. This equipment generates, uses, and can radiate radio frequency energy and, if not installed and used in accordance with the instruction manual, may cause harmful interference to radio communications. Operation of this equipment in a residential area is likely to cause harmful interference in which case the user will be required to correct the interference at his own expense.

WARNING

Changes or Modifications not expressly approved by Evertz Microsystems Ltd. could void the user's authority to operate the equipment.

Use of unshielded plugs or cables may cause radiation interference. Properly shielded interface cables with the shield connected to the chassis ground of the device must be used.

Evertz Microsystems Ltd



For Home or Office Use

Tested to comply with
FCC Standards

This device complies with part 15 of the FCC Rules.
Operation is subject to the following two conditions:

This device may cause harmful interference, and
This device must accept any interference received, including
interference that may cause undesired operation.

REVISION HISTORY

<u>REVISION</u>	<u>DESCRIPTION</u>	<u>DATE</u>
0.1	Preliminary	Feb 2007
0.2	Reformatted sections, added specifications	May 2007
0.3	Updated information on setting the IP address Added information on EQX communication ports	May 2007
0.4	Added Safety instructions into installation section	Jul 2007
0.5	Updated module IP addresses and LED functions	Sep 2007
1.0	Released Version Added setup instructions (section 2.2) Added instructions on setting the frame controller IP address (section 8.1)	Nov 2007 Nov 2007
1.1	Updated Safety warnings in Installation instructions and drawings	Feb 2008
1.2	Added Optical Input, Output, SFP, performance information	Jan 2009
1.3	Updates to monitoring connections, LEDs, menus, etc Added information on connections to DC power sources	Feb 2009
1.4	Added rear plate information (sections 4.4.3 to 4.4.6)	Feb 2009
2.0	Major updates throughout manual	Feb 2011
2.1	Major updates throughout manual Added VISTALINK [®] Remote Monitoring/Control (section 12)	Jan 2014
2.2	Added information on X-Link Covers	Jan 2015
3.0	Major updates throughout manual Added EQX10 information	Mar 2015
3.1	Updates throughout	Feb 2017

Information contained in this manual is believed to be accurate and reliable. However, Evertz assumes no responsibility for the use thereof nor for the rights of third parties, which may be affected in any way by the use thereof. Any representations in this document concerning performance of Evertz products are for informational use only and are not warranties of future performance, either expressed or implied. The only warranty offered by Evertz in relation to this product is the Evertz standard limited warranty, stated in the sales contract or order confirmation form.

Although every attempt has been made to accurately describe the features, installation and operation of this product in this manual, no warranty is granted nor liability assumed in relation to any errors or omissions unless specifically undertaken in the Evertz sales contract or order confirmation. Information contained in this manual is periodically updated and changes will be incorporated into subsequent editions. If you encounter an error, please notify Evertz Customer Service department. Evertz reserves the right, without notice or liability, to make changes in equipment design or specifications.

This page left intentionally blank

TABLE OF CONTENTS

1	OVERVIEW	1
1.1	SIGNAL FLOW OVER-VIEW.....	2
1.2	SIGNAL AND SYSTEM MONITORING	4
2	INSTALLATION.....	5
2.1	PHYSICAL INSTALLATION	5
2.1.1	EQX Packaging Materials	5
2.1.2	Dismantling the Wooden Shipping Container.....	6
2.1.3	EQX Router Frames	7
2.2	ELECTRICAL CONNECTIONS	9
2.2.1	Video Inputs and Outputs	9
2.2.2	Video Sync (Reference Input).....	10
2.2.3	Manual Remote Control - Using Q-Link	10
2.3	CONNECTING AN AC POWER SUPPLY.....	10
2.4	POWER UP.....	12
2.4.1	Power Supply - Key Features	13
2.5	GETTING STARTED: SETUP INSTRUCTIONS	15
3	FRAME TYPES	17
3.1	STANDARD 26RU, 16RU AND 10RU	17
3.2	26RU WITH XLINK EXPANSION OUTPUTS.....	18
3.3	16RU WITH SINGLE XLINK EXPANSION	20
3.3.1	16RU with Two Xlink Expansions	21
3.3.2	16RU with three Xlink expansions	21
3.4	10RU WITH XLINK EXPANSION OUTPUTS.....	23
3.4.1	X-Link Cover (16RU and 26RU).....	24
4	CONTROL.....	25
5	SIGNAL PATH MODULES.....	27
5.1	EQX-IP18-3G/EQX-G-IP18-3G MODULE	27
5.1.1	EQX-IP18-3G/EQX-G-IP18-3G - Key Features.....	27
5.1.2	EQX-IP16-3G-2TDM (AUDIO VIDEO INPUT PROCESSOR)	30
5.1.2.1	AVIP Module - Key Features.....	31
5.1.3	EQX-IP18-3G-F1 MODULE	36
5.1.3.1	EQX-IP18-3G-F1 - Key Features	36
5.1.4	EQX-IP16AD-3G-2TDM-F1 (FIBER AUDIO VIDEO INPUT PROCESSOR).....	37
5.1.4.1	EQX-IP16AD-3G-2TDM-F1 - Key Features	37
5.1.5	Fiber Optic Inputs	38
5.1.6	EQX-IP18FSAD-3G	39
	EQX-FK-AE	39
	EQX-FK-DSP.....	39
5.1.6.1	EQX-IP18FSAD-3G Modules Key Features.....	39
5.1.7	EQX-IP18AD-3G.....	40

5.1.7.1	EQX-IP18AD-3G Modules Key Features.....	40
5.2	26RU AND 16RU EQX CROSSPOINT MODULE.....	44
5.2.1	EQX-XPT 576X576	44
5.2.2	EQX-XPT 576X288	44
5.2.3	EQX-XPT 288X288	45
5.2.4	Crosspoint - Key Features.....	45
6	10RU EQX CROSSPOINT MODULE.....	49
6.1	EQX10-XPTG 180X288.....	50
6.1.1	Crosspoint - Key Features.....	50
6.2	EQX10-XPTG-ADMX10.....	51
6.2.1	Crosspoint - Key Features.....	51
6.3	EQX-OP18-3G/EQX-G-OP18-3G MODULES.....	52
6.3.1	Supported Reclocking Signal Frequencies	53
6.3.2	EQX-OP18-3G/ EQX-G-OP18-3G - Key Features.....	53
6.3.3	EQX-OP16AE-3G-2TDM (AUDIO VIDEO Output Processor)	57
6.3.3.1	EQX-OP16AE-3G-2TDM - Key Features.....	57
6.3.4	EQX-OP18-3G-F1 Modules.....	60
6.3.4.1	EQX-OP18-3G-F1 - Key Features.....	61
6.3.5	EQX-OP16AE-3G-2TDM-F1 (FIBER AUDIO VIDEO output processor)	61
6.3.5.1	EQX-OP16AE-3G-2TDM-F1 - Key Features	62
6.3.6	Fiber Optic Outputs	62
6.3.7	EQX-OP18-3G (HD)-EX/EQX-OP36-3G (HD)-XIO.....	63
6.3.7.1	EQX-OP18-3G (HD)-EX/EQX-OP36-3G (HD)-XIO - Key Features.....	64
6.4	EQX INPUT & OUTPUT (I/O) REAR PLATES	67
6.4.1	Coaxial I/O RP - Key Features	67
6.4.2	AVIP/AVOP RP - Key Features	69
6.4.3	Fiber Optic I/O RP - Key Features.....	71
6.4.4	Fiber Optic AVIP/AVOP RP - Key Features.....	72
6.4.5	Fiber optic EQX-IP18FSAD-3G-F RP Key Features	73
6.4.6	XLINK Output RP - Key Features	76
6.4.7	EQX-OP18-3G-XLINK RP – Key Features	79
6.4.8	Double Density Output RP - Key Features	81
6.4.9	Double Density Output RP - Key Features	82
6.4.10	EQX-IP18FSAD-3G RP - Key Features.....	83
6.4.11	EQX-IP18AD-3G-XLink-RP8 RP - Key Features	84
6.4.12	EQX-IP18-XLink-RP8 - Key Features.....	85
6.4.13	EQX-IP18-XLink-EX-RP8 - Key Features.....	86
6.4.14	XIO (DD) Output DIN RP8 - Key Features.....	87
6.4.15	XIO (DD) Output X-Link RP - Key Features.....	88
6.5	XLINK CABLES	89
6.5.1	X-LINK cable part numbers:	89
6.6	XLINK BREAK-OUT PANELS	92
6.6.1	XLINK-BHP2U-96C	92
6.6.2	XLINK-BHP1U-96DIN	92
6.6.3	XLINK-BHP4U-288DIN.....	93
6.6.4	XLINK-BHP4U-288DIN-1X2	94
7	CONTROL AND MONITORING MODULES	95

7.1	EQX FRAME CONTROLLER	95
7.1.1	Frame Controller - Key Features.....	95
7.2	EQX COMMUNICATION PORTS	98
7.2.1	Upper Communication RP (Left Side).....	100
7.2.2	Lower Communication RP (Left Side).....	101
7.2.3	Upper Communication RP (Right Side).....	102
7.2.4	Lower Communication RP (Right Side).....	103
7.3	EQX REFERENCE INPUT	104
7.3.1	Reference Input - Key Features	105
7.4	EQX 26RU AND 16RU MONITORING OUTPUTS	105
8	COOLING MODULES FOR 26 AND 16RU FRAMES	109
8.1	EQX INPUT & OUTPUT MODULE COOLING	109
8.1.1	I/O Fan Modules - Key Features	112
8.2	EQX CROSSPOINT FAN MODULES	113
8.2.1	Crosspoint Fan Modules - Key Features	114
9	COOLING MODULES FOR EQX10 FRAME	115
9.1	EQX10 INPUT AND OUTPUT COOLING MODULES	115
9.1.1	EQX10 Cooling module	115
9.1.2	I/O Fan Modules - Key Features	116
9.2	EQX CROSSPOINT FAN MODULES	116
10	CONFIGURING EQX USING WINSETUP	117
10.1	LEVELS	118
10.2	FRAMES	120
10.3	EQX ROUTER CONFIGURATION	124
10.3.1	Router Hardware Configuration	125
10.3.2	Timing Plane Configuration.....	126
10.3.3	Default Signal Parameters	127
10.3.4	Advanced Signal Parameters.....	128
10.3.5	Creating an Exception Rule	129
10.3.6	Ethernet Configuration	130
10.4	ROUTE SETTINGS (MAP FILE SELECTION)	133
10.4.1	Router Mode.....	134
10.4.2	Outputs	135
10.5	PORT SETUP	136
10.5.1	Control Panel Q-Link Interface.....	136
10.5.2	Serial Interface	137
10.5.3	Ethernet Interface	137
10.6	DEVICE BINDING AND EQX XLINK VIPX MAPPING	138
10.7	SOURCES	138
10.8	DESTINATIONS	139
10.9	CONTROL PANELS	141
10.10	SPECIAL INTERFACES	142

10.11	COMMUNICATION WINDOW.....	142
10.12	DOWNLOAD.....	143
11	FIRMWARE UPGRADE.....	145
11.1	FTP METHOD.....	145
11.1.1	UPGRADING FRAME CONTROLLER.....	145
11.1.2	UPGRADING I/O AND MONITOR MODULES.....	146
11.2	SERIAL METHOD.....	147
12	IP ADDRESSES CONFIGURATION FOR FLINK SYSTEM.....	149
12.1	EQX FRAME CONTROLLER(S) IP ADDRESS CONFIGURATION.....	149
12.2	IP ADDRESS CONFIGURATION FOR ALL OTHER EQX MODULES.....	151
13	TECHNICAL DESCRIPTION.....	153
13.1	SPECIFICATIONS.....	153
13.1.1	Configuration.....	153
13.1.2	Video Inputs.....	153
13.1.3	Video Outputs.....	153
13.1.4	Fiber Output/Input.....	154
13.1.5	Reference Timing.....	154
13.1.6	Control.....	154
13.1.7	Physical.....	154
13.1.8	Electrical – Router.....	154
13.1.9	Electrical – External Power Supply.....	155
13.2	CONNECTOR PIN-OUTS.....	155
13.2.1	Serial Ports.....	155
13.2.2	Ethernet Connections.....	156
13.2.3	Connecting to an Ethernet Network.....	156
13.2.4	Alarm Connector.....	157
14	VISTALINK® REMOTE MONITORING/CONTROL.....	159
14.1	WHAT IS VISTALINK®?.....	159
14.2	VISTALINK® REMOTE MONITORING/CONTROL FOR EQX-FC.....	160
14.2.1	General Monitoring for EQX-FC.....	160
14.2.2	Timing Plane Status.....	161
14.2.3	Module Status.....	162
14.2.4	Fan Status.....	163
14.2.5	Output status.....	164
14.2.6	Fault Traps, Fan Fault and Input fault.....	165
14.3	VISTALINK® REMOTE MONITORING/CONTROL FOR EQX-IP18-3G/G/XIO.....	166
14.3.1	Main Tabs for EQX Input module.....	166
14.3.2	Tabs for Individual Input.....	168
14.4	VISTALINK® REMOTE MONITORING/CONTROL FOR EQX-IP16AD/3G/F1.....	169
14.4.1	Main Tabs for AVIP/F1 Module.....	169
14.4.2	Tabs for Individual AVIP/F1 Input.....	170
14.5	VISTALINK® REMOTE MONITORING/CONTROL FOR EQX-IP18-3G-F1.....	171
14.5.1	Main Tabs for EQX-IP18-3G-F1 Module.....	171
14.5.2	Tabs for individual Fiber Input.....	173

14.6	VISTALINK® REMOTE MONITORING/CONTROL FOR EQX-IP18AD-3G-2TDM	174
14.6.1	Main Tabs for EQX-IP18AD-3G-2TDM Module.....	174
14.6.2	Tabs for Individual Input.....	176
14.7	VISTALINK® REMOTE MONITORING/CONTROL FOR EQX-IP18FSAD-3G-2TDM.....	177
14.7.1	Main Tabs for EQX-IP18FSAD-3G Module	177
14.7.2	Tabs for Individual Input.....	179
14.8	VISTALINK® REMOTE MONITORING/CONTROL FOR EQX-OP18-3G/EQX-G-OP18-3G	181
14.8.1	Main Tabs for EQX-OP18-3G/EQX-3-OP18-3G Module	181
14.8.2	Tabs for Individual Output.....	182
14.9	VISTALINK® REMOTE MONITORING/CONTROL FOR EQX-OP16AE-3G/F1	183
14.9.1	Main Tabs for EQX-AVOP/F1	183
14.9.2	Tabs for Individual EQX-AVOP/F1 Output	184
14.10	VISTALINK® REMOTE MONITORING/CONTROL FOR EQX-OP18-3G-F1	185
14.10.1	Main Tabs for EQX-OP18-3G-F1 Module	185
14.10.2	Tabs for Individual Fiber Output.....	187
15	APPENDIX A - VIDEO REDUNDANT PATH MONITORING	188
16	APPENDIX B - REDUNDANCY MODES.....	193
17	APPENDIX C - Q-LINK – EQX CONTROL PANEL NETWORK.....	195

Figures

Figure 1-1	: EQX Router (26RU, 16RU and 10RU).....	1
Figure 1-2	: EQX Signal Flow Diagram	2
Figure 1-3	: EQX10 Signal Flow Diagram	3
Figure 1-4	: EQX Signal Monitoring Path	4
Figure 2-1	: EQX Shipping Container	5
Figure 2-2	: EQX with Shipping Panels Removed.....	5
Figure 2-3	: EQX Frame Connection	8
Figure 2-4	: EQX Rear View (26RU EQX).....	9
Figure 2-5	: EQX External Power Supply	10
Figure 2-6	: EQX External Power Supply – Tray holding 4 modules	11
Figure 2-7	: EQX External Power Supply – Ground Terminal Location	12
Figure 2-8	: External Power Switch	13
Figure 2-9	: EQX External Power Supply – Connection to Older EQX Frames.....	14
Figure 2-10	: EQX External Power Supply – Connection to New EQX Frames	14
Figure 3-1	: Standard 26RU Frames and 16RU Frames	18
Figure 3-2	: 26RU with XLINK Expansion Outputs.....	19
Figure 3-3	: 26 RU Top X-Link connectors.....	19
Figure 3-4	: 26 RU Bottom X-Link connectors.....	20
Figure 3-5	: 16RU Frames with Single Xlink Expansion	20
Figure 3-6	: 16RU Frame with Two Xlink Expansions.....	21
Figure 3-7	: 16RU Frame with Three Xlink Expansions	22
Figure 3-8	: 16RU X-Link expansion 3	22
Figure 3-9	: 16RU X-Link expansions 1 and 2	22
Figure 3-10	: 10RU with Default and optional Xlink Expansion Outputs.....	23
Figure 3-11	: Xlink Expansion 1 Outputs.....	23
Figure 3-12	: XLINK Expansion 2 Outputs	24

Figure 3-13 : XLINK Expansion 3 Outputs	24
Figure 3-14 : EQX16-FR X-Link Cover.....	25
Figure 3-15 : EQX26FR X-Link Cover.....	25
Figure 5-1 : EQX-IP18-3G (with Air Dam Fitted)	28
Figure 5-2 : EQX-G-IP18-3G (with Air Dam Fitted)	28
Figure 5-3 : EQX-IP18-3G – Air Dam Detail	28
Figure 5-4 : EQX-G-IP18-3G – Air Dam Detail	28
Figure 5-5 : EQX-IP18-3G/EQX-G-IP18-3G – Mounted in Upper Frame (with Air Dam Removed).....	28
Figure 5-6 : EQX-IP18-3G/EQX-G-IP18-3G – Mounted in Lower Frame (with Air Dam Removed).....	29
Figure 5-7 : AVIP on the Left mounted in upper frame/ AVIP on the right mounted in the lower frame	32
Figure 5-8 : Physical input and output of AVIP/AVOP at the back of EQX frame.....	33
Figure 5-9 : SFP1R-2 Module	38
Figure 5-10 : EQX-IP18FS/AD-3G – Mounted in Upper Frame (with Air Dam Removed)	41
Figure 5-11 : EQX-IP18FS/AD-3G – Mounted in Lower Frame (with Air Dam Removed)	41
Figure 5-12 : EQX-XPT-288X288/576X288	45
Figure 5-13 : EQX-XPT-576X576.....	46
Figure 5-14 : EQX-XPTG-288X288.....	46
Figure 5-15 : EQX-XPTG-576X576/576X288	47
Figure 6-1 : EQX10-XPTG-180X288.....	50
Figure 6-2 : EQX10-XPTG-ADMX10.....	51
Figure 6-3 : EQX-OP18-3G (with Air Dam Fitted)	54
Figure 6-4 : EQX-G-OP18-3G (with Air Dam Fitted)	54
Figure 6-5 : EQX-OP18-3G – Air Dam Detail.....	54
Figure 6-6 : EQX-G-OP18-3G – Air Dam Detail.....	54
Figure 6-7 : EQX-OP18-3G/EQX-G-OP18-3G – Mounted in Upper Frame (with Air Dam Removed)	54
Figure 6-8 : EQX-OP18-3G/EQX-G-OP18-3G – Mounted in Lower Frame (with Air Dam Removed)	55
Figure 6-9 : AVOP on the Left mounted in upper frame/ AVOP on the right mounted in the lower frame	58
Figure 6-10 : Physical input and output of AVIP/AVOP at the back of EQX frame.....	59
Figure 6-11 : SFP1T-13-2 Module.....	62
Figure 6-12 : Orientation of the SFPs for two different slots	63
Figure 6-13 : EQX-OP18-3G-EX/EQX-OP36-3G-XIO– Mounted in Upper Frame (with Air Dam Removed) 65	
Figure 6-14 : EQX-OP18-3G-EX/EQX-OP36-3G-XIO– Mounted in Lower Frame (with Air Dam Removed) 65	
Figure 6-15 : EQX-IO18-RP	68
Figure 6-16 : EQX-IO18-RP	70
Figure 6-17 : EQX-IO18-RP	70
Figure 6-18 : EQX-IO18F-RP	71
Figure 6-19 : EQX-IP16AD-3G-2TDM-F1-RP/EQX-OP16AE-3G-2TDM-F1-RP (Top Slot)	72
Figure 6-20 : EQX-IP16AD-3G-2TDM-F1-RP/EQX-OP16AE-3G-2TDM-F1-RP (Bottom slot).....	73
Figure 6-21 : EQX-IP18FSAD-3G-F RP (Top Slot).....	74
Figure 6-22 : EQX-IP18FSAD-3G-F (Bottom Slot).....	75
Figure 6-23 : XLINK Output RP Top Slot	77
Figure 6-24 : XLINK Output RP Bottom Slot	78
Figure 6-25 : EQX-OP18-3G-XLINK RP (Top Slot)	79
Figure 6-26 : EQX-OP18-3G-XLINK RP (Bottom Slot)	80
Figure 6-27 : EQX-IO18-DIN-RP	81
Figure 6-28 : Double Density I/O RP	82
Figure 6-29 : EQX-IP18FSAD-3G	83
Figure 6-30 : EQX-IP18AD-3G-XLink-RP8	84
Figure 6-31 : EQX-IP18-XLINK-RP8.....	85
Figure 6-32 : EQX-IP18-XLINK-EX-RP8.....	86
Figure 6-33 : EQX-OP18-DIN-RP8	87
Figure 6-34 : EQX-OP36-XLINK-RP8	88
Figure 6-35 : X-LINK-BHP-5.....	90

Figure 6-36 : XLINK-BHPS-5/BHP-5-EQX1FR	90
Figure 6-37 : 7 XLINK-BHP-5 to BNC	91
Figure 6-38 : XLINK-BHP2U-96C.....	92
Figure 6-39 : XLINK-BHP1U-96DIN	92
Figure 6-40 : XLINK-BHP4U-288DIN	93
Figure 6-41 : XLINK-BHP4U-288DIN-1X2	94
Figure 7-1 : Frame Controller Module Card Edge Controls and Connectors.....	96
Figure 7-2 : Frame Controller Module Status LEDs	96
Figure 7-3 : F-LINK and Q-LINK Connectors	98
Figure 7-4 : EQX 26RU and 16RU Communication Ports	98
Figure 7-5 : EQX10 Communication Ports.....	99
Figure 7-6 : Communication RP for 26RU and 16RU frames	99
Figure 7-7 : Communication RP for EQX10 frames	100
Figure 7-8 : Communication RP for 26RU and 16RU frames	101
Figure 7-9 : Communication RP EQX10	102
Figure 7-10 : EQX Reference Input.....	104
Figure 7-11 : Monitor 1 (Right Side of Frame).....	105
Figure 7-12 : EQX Signal Monitoring Path – Monitor 1 (RHS)	106
Figure 7-13 : Monitor 2 (Left Side of Frame).....	106
Figure 7-14 : EQX Signal Monitoring Path – Monitor 2 (LHS).....	107
Figure 7-15 : Video Output Monitoring	108
Figure 8-1 : EQX-FAN-HF	110
Figure 8-2 : EQX-FAN-QT	110
Figure 8-3 : EQX Frame Air Flow with HF Cooling Modules.....	111
Figure 8-4 : EQX Frame Air Flow with QT Cooling Modules.....	112
Figure 8-5 : Cooling Fans for Module.....	113
Figure 8-6 : EQX-XPT-576X576 Cooling Fan	114
Figure 8-7 : EQX-XPTG-576X576 Cooling Fan	114
Figure 8-8 : EQX Crosspoint Module Air Flow – Top View	114
Figure 9-1 : EQX10-FAN-QT	115
Figure 9-2 : EQX10 Frame Air Flow	116
Figure 10-1 : Quartz System Configuration Editor Window	117
Figure 10-2 : Creating the “Main Video Route” Level	118
Figure 10-3 : Creating the “Backup Video Route” Level.....	119
Figure 10-4 : Selecting the Frame Type.....	120
Figure 10-5 : New Frame Window – Default setting when first opened.....	121
Figure 10-6 : New Frame Window – Set for “Two parts”	122
Figure 10-7 : New Frame Window – Enter the Required Input and Output Values	123
Figure 10-8 : EQX Configuration Window (WinSetup version4.XX)	124
Figure 10-9 : EQX Configuration Window – Showing the Advanced Signal Parameters.....	128
Figure 10-10 : Current Exceptions Window.....	129
Figure 10-11 : Exception Rules	130
Figure 10-12 : Ethernet Configuration Step 1.....	131
Figure 10-13 : Set IP Address Window	132
Figure 10-14 : Route Settings Window.....	134
Figure 10-15 : Output Window Selection.....	136
Figure 10-16 : Ethernet Port Settings for External Control.....	137
Figure 10-17 : Source Definition Window.....	138
Figure 10-18 : Destination Definition Window	140
Figure 10-19 : Key Definition Window	141
Figure 10-20 : COM1 Window	142
Figure 12-1 : HyperTerminal Main Menu.....	149
Figure 12-2 : Network Configuration Menu	150

Figure 13-1 : Example Alarm Circuit	158
Figure 14-1 : General Monitoring Tab for EQX-FC	160
Figure 14-2 : Timing Plane Status for EQX-FC	161
Figure 14-3 : Module Status for EQX-FC	162
Figure 14-4 : Fan Status for EQX-FC	163
Figure 14-5 : Output Status for EQX-FC	164
Figure 14-6 : Fault Trap Tab for EQX-FC	165
Figure 14-7 : Main Tabs for EQX Input	166
Figure 14-8 : Tabs for Individual Input	168
Figure 14-9 : Main Tabs for AVIP/F1 Module	169
Figure 14-10 : Tabs for Individual AVIP/F1 Input	170
Figure 14-11 : Main Tabs for EQX-IP18-3G-F1 Module (1)	171
Figure 14-12 : Main Tabs for EQX-IP18-3G-F1 Module (2)	172
Figure 14-13 : Tabs for Individual Fiber Input	173
Figure 14-14 : Main Tabs for EQX-IP18AD-3G-2TDM Module	174
Figure 14-15 : Tabs for Individual Input for EQX-IP18AD-3G-2TDM Module	176
Figure 14-16 : Main Tabs for EQX-IP18FSAD-3G Module	178
Figure 14-17 : Tabs for Individual Input for EQX-IP18FSAD-3G Module	179
Figure 14-18 : Main Tabs for EQX-OP18-3G/EQX-3-OP18-3G Module	181
Figure 14-19 : Tabs for Individual Output	182
Figure 14-20 : Main Tabs for EQX-AVOP/F1	183
Figure 14-21 : Tabs for Individual EQX-AVOP/F1 Output	184
Figure 14-22 : Main Tabs for EQX-OP18-3G-F1 Module	185
Figure 14-23 : Tabs for Individual Fiber Output	187
Figure 15-1 : Level Status Window	188
Figure 15-2 : PC Comms Window in WinSetup	189
Figure 15-3 : Source Definition	190
Figure 15-4 : FC Config Menu	191
Figure 15-5 : EQX-FC Config in VLPRO	191
Figure 17-1 : Daisy Chain Configuration of Q-Link Panels	195
Figure 17-2 : Q-Link Connector on the remote control panel	196
Figure 17-3 : T-piece Connector	196

Tables

Table 5-1 : Component Description of EQX Input Modules	30
Table 5-2 : Component Description Of EQX AVIP Modules	34
Table 5-3 : LED Description Of EQX-IP18AD-3G Modules	43
Table 5-4 : LED Description Of Crosspoint Modules	47
Table 6-1 : LED Description Of EQX10-XPTG-180X288	50
Table 6-2 : LED Description Of EQX10-XPTG-ADMX10	52
Table 6-3 : Component Description Of EQX-OP18-3G/ EQX-G-OP18-3G Modules	56
Table 6-4 : Component Description Of AVIP/AVOP Modules	60
Table 6-5 : Crosspoint Profile Modes	64
Table 6-6 : LED Description	66
Table 7-1 : EQX Frame Controller Switch Functions	96
Table 7-2 : LED Description Of Frame Controller Module	97
Table 10-1 : EQX Modules IP Addresses	133
Table 10-2 : Maps for Router Mode	135
Table 13-1 : RS422 Serial Port Pin-out	155
Table 13-2 : RS232 Serial Port Pin-out	156
Table 13-3 : Standard RJ-45 Wiring Colour Codes	157
Table 14-1 : EQX-FC Parameter	160
Table 14-2 : Timing Plane Parameter for EQX-FC	161

Table 14-3 : Module Status Parameter for EQX-FC	162
Table 14-4 : Fan Status Parameter	163
Table 14-5 : Output Status for EQX-FC	164
Table 14-6 : Fault Trap Parameter for EQX-FC	165
Table 14-7 : Main Tabs Description for EQX Input.....	167
Table 14-8 : Individual Input Tabs Description	168
Table 14-9 : Main Tabs Description for AVIP/F1 Module	169
Table 14-10 : Tabs for Individual AVIP/F1 Input Description	170
Table 14-11 : Main Tabs Description for Main Tabs for EQX-IP18-3G-F1 Module	173
Table 14-12 : Tabs for Individual Fiber Input Description	174
Table 14-13 : Main Tabs Description for EQX-IP18AD-3G-2TDM Module.....	175
Table 14-14 : Tabs for Individual Input Description for EQX-IP18AD-3G-2TDM Module	176
Table 14-15 : Main Tabs Description for EQX-IP18FSAD-3G Module	179
Table 14-16 : Tabs for Individual Input Description for EQX-IP18FSAD-3G Module.....	180
Table 14-17 : Main Tabs Description for EQX-OP18-3G/EQX-3-OP18-3G Module.....	181
Table 14-18 : Tabs for Individual Output Description	182
Table 14-19 : Main Tabs Description for EQX-AVOP/F1	183
Table 14-20 : Tabs for Individual Description for EQX-AVOP/F1 Output	184
Table 14-21 : Main Tabs Description for EQX-OP18-3G-F1 Module.....	186
Table 14-22 : Tabs for Individual Fiber Output Description.....	187

This page left intentionally blank

1 OVERVIEW

Thank you for selecting the Quartz brand of Evertz products for use in your video/audio system. The EQX router offers outstanding quality and value, and will provide a long and cost effective working life with the minimum of maintenance.

In order to offer the best in customer support, Evertz supplies the EQX router with a full one-year manufacturing warranty.



Figure 1-1 : EQX Router (26RU, 16RU and 10RU)

1.1 SIGNAL FLOW OVER-VIEW

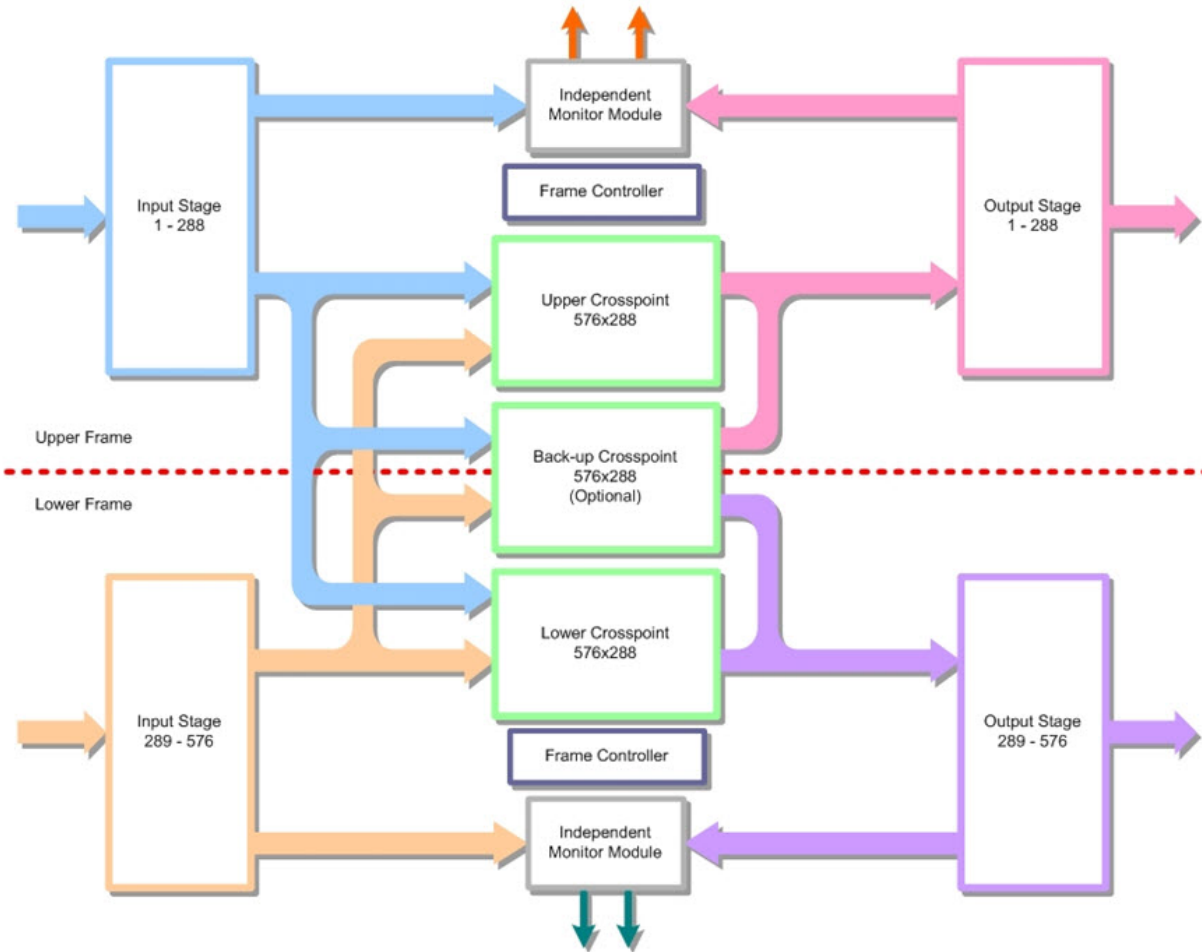

Figure 1-2 : EQX Signal Flow Diagram

The simple design and signal flow of the EQX-26FR is shown in Figure 1-2. There are four main active module types:

- **Input Module** (x32)
- **Crosspoint Module** (x2 main and x1 back-up)
- **Output Module** (x32)
- **Frame Controller Module** (x1 main and x1 redundant)

All of the active modules are accessible from the front of the EQX frame providing easy access during maintenance.

The Back-up crosspoint module provides full protection in the case of a failed route. The switch over to the back-up crosspoint can be performed manually or automatically. In the event of a failure, only the faulty route needs to be switched over to the back-up crosspoint. The new route is checked before it is switched through the back-up crosspoint by the EQX monitoring facility.

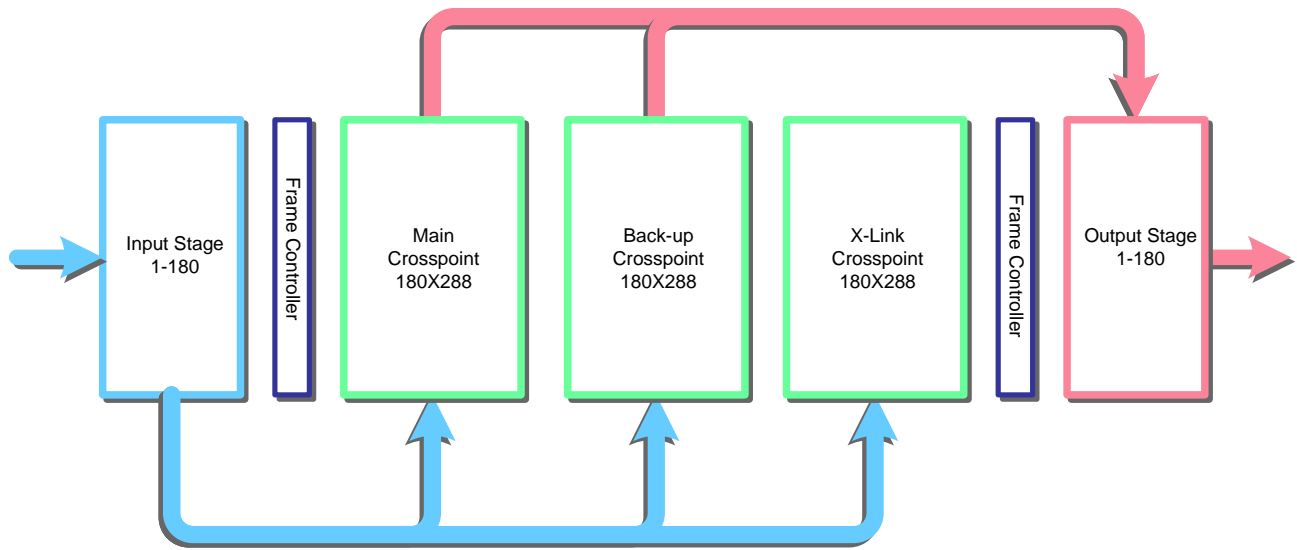

Figure 1-3 : EQX10 Signal Flow Diagram

The simple design and signal flow of the EQX10-FR is shown in Figure 1-3. There are four main active module types:

- **Input Module** (x10)
- **Crosspoint Module** (x1 main, x1 back-up and Xlink)
- **Output Module** (x10)
- **Frame Controller Module** (x1 main and x1 redundant)

All of the active modules are accessible from the front of the EQX10 frame providing easy access during maintenance.

The Back-up crosspoint module provides full protection in the case of a failed route. The switch over to the back-up crosspoint can be performed manually or automatically. In the event of a failure, only the faulty route needs to be switched over to the back-up crosspoint. The new route is checked before it is switched.

1.2 SIGNAL AND SYSTEM MONITORING

The EQX supports full signal monitoring of both inputs and outputs. It also incorporates comprehensive system monitoring, including power supply voltages, interior temperatures and fan speeds. Monitored data is available through SNMP for facility-wide monitoring systems such as VLPRO. System status may also be monitored remotely by a network based remote connection over TCP/IP. User configurable closing contacts are also provided for connection to an external alarm system.

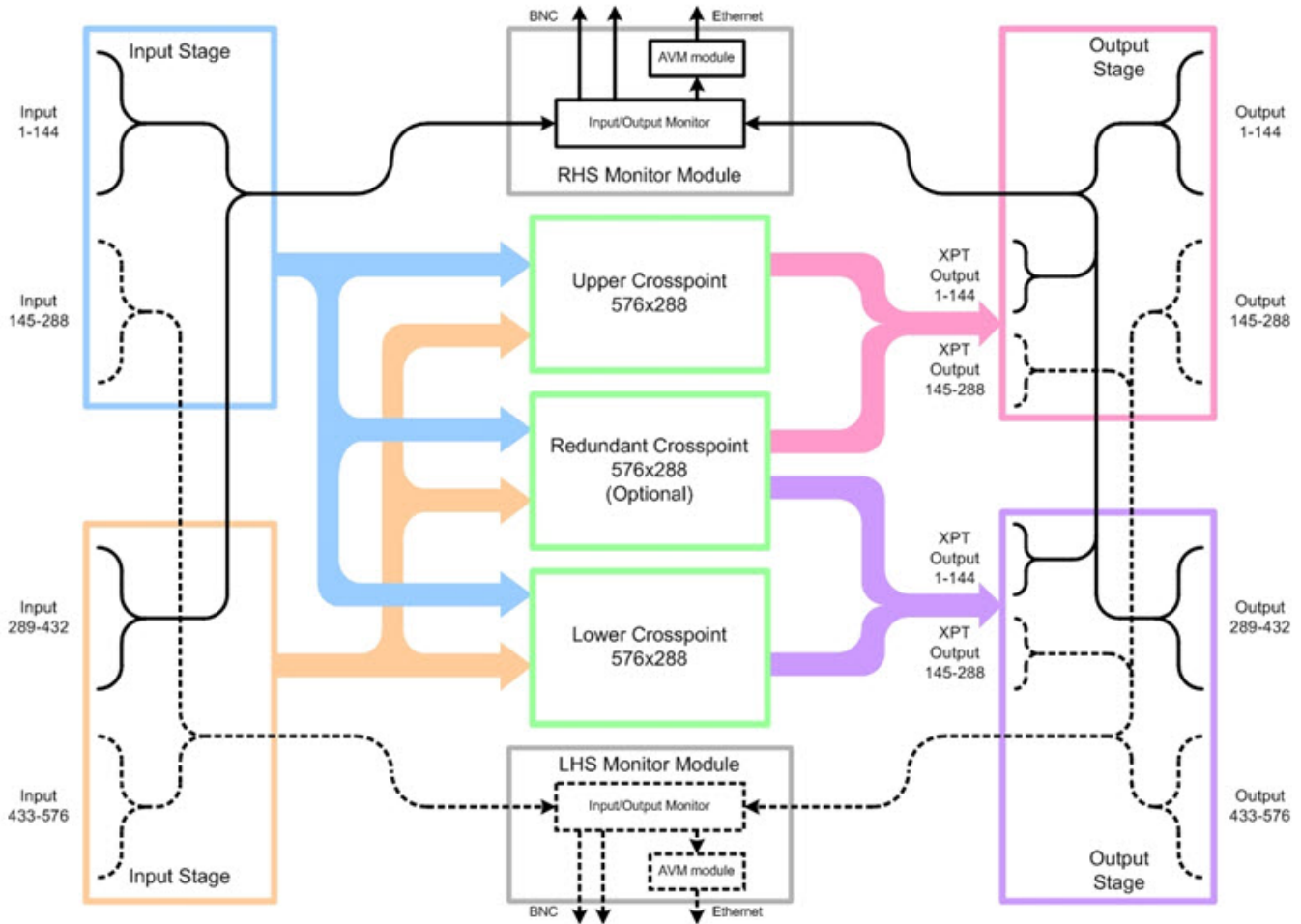

Figure 1-4 : EQX Signal Monitoring Path

2 INSTALLATION

2.1 PHYSICAL INSTALLATION

2.1.1 EQX Packaging Materials

The instructions provided in this section outline the EQX unpacking procedure. Please review the following instructions before opening and moving the shipping container. Once the EQX is unpacked, please refer to section 2.1.3 for instructions on installing the router.

The Evertz EQX packaging consists of the following components:

- Wooden shipping container (consists of two wooden side panels, one front panel, one back panel and a wooden top cap)
- Pallet
- Foam packaging materials
- Protective Bags
- Unpacking Instructions and EQX User manual

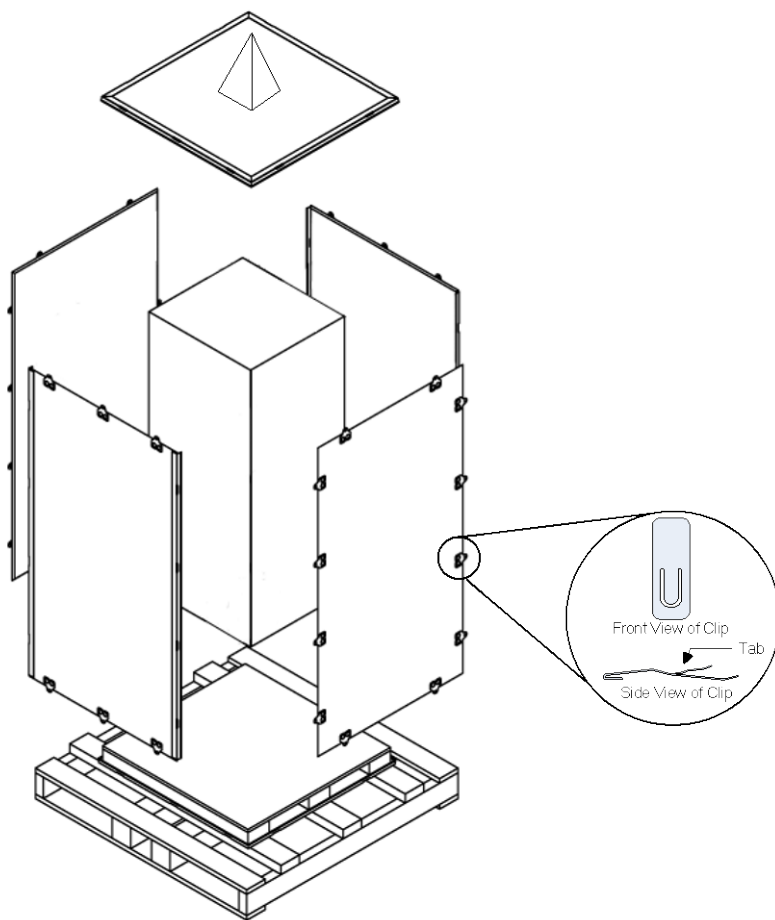

Figure 2-1 : EQX Shipping Container

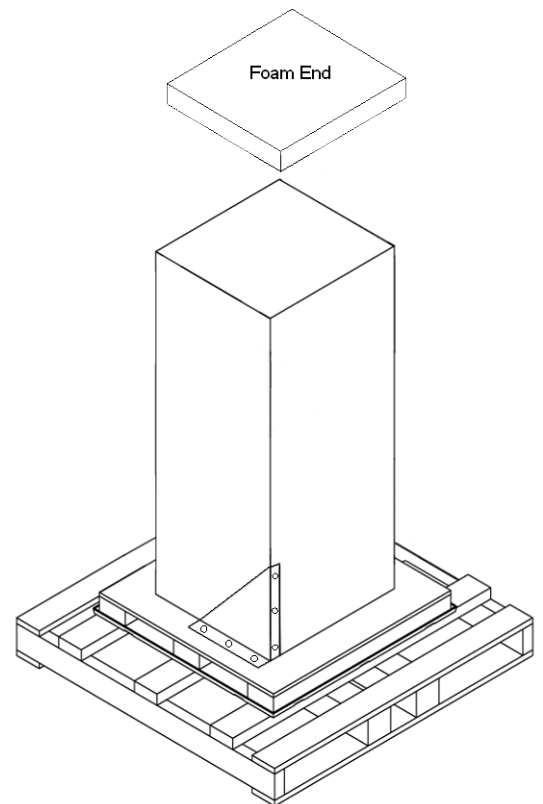

Figure 2-2 : EQX with Shipping Panels Removed

2.1.2 Dismantling the Wooden Shipping Container

Please read and follow the instructions outlined below in order to safely dismantle the wooden shipping container:



Use caution when handling the packaging components. The wooden side panels, wooden cap and the pallet may have sharp metal edges.



There is a cone attached to the top of the EQX shipping container to prevent people from stacking objects on the container. If the cone has been removed or crushed, this may indicate that objects were stacked on the unit.

To dismantle the wooden shipping container, please follow the steps outlined below:

1. Three people are required in order to safely dismantle the shipping container. When moving the system to a different location, it is essential that a handcart, pallet jack, or forklift be used. Care should be taken to avoid jarring the EQX frame.



CAUTION – Do not attempt to lift or move the fully assembled EQX from the pallet. Please note that the weight of the EQX can range from 400 lbs (181.44 kg) to 500 lbs (226.8 kg) depending on the type of unit shipped (16RU or 26RU).

2. The dimensions of the EQX shipping container are: 40-inches (101.6 cm) wide, 40-inches (101.6 cm) long, and 56 inches (142.2 cm) high (66 inches including the cardboard shipping cone). Before moving the shipping container, take note of the dimensions to ensure that there is sufficient clearance space when transporting it through doors and passageways. Move the EQX shipping container as close to the installation location by transporting it via a handcart, pallet jacket or forklift. Ensure that there is an adequate amount of space to comfortably unpack and assemble the system.
3. It is imperative that at least two people are securing the box while another person removes the clips and panels to ensure that the panels do not fall and cause personal injury or damage to the EQX unit.
4. There are 8 clips securing each wooden side panel to the front and back panels. Remove each clip by pressing the tab on the clip and pushing the clip out from under the metal clasp. Repeat this step for all 8 clips. At this time, **DO NOT** remove the clips securing the panels to the top cap or bottom pallet.
5. Repeat step 4 to unhinge the other side panel.
6. All 16 side clips should now be removed from the side, front and back panels. Depending on the shipping container size there may be 8, 10 or 14 clips securing the cap to the top of the wooden packaging unit. Remove each clip by pressing the tab on the clip and pushing the clip out from under the metal clasp.

7. Once all the clips are removed from the top cap, ensure at least two people are securing the side panels while another person carefully lifts and removes the top cap.
8. Ensure at least two people are safely securing the side, front and back panels before removing the bottom clips. Remove the 2, 3 or 4 clips that are securing the front panel to the pallet. Carefully lift and remove the panel. Set the panel aside. Repeat this procedure for the remaining panels.



It is important to retain the shipping container, shipping container materials and accessories for future shipping use.

9. Once all the panels are removed, set them aside. Remove the foam cap ends from the top and bottom of the EQX.
10. Remove the protective packaging bag that is covering the EQX.
11. Open the EQX door and remove the protective packaging bag(s) from inside the unit.
12. Remove the bolts from the side and bottom ears of the triangle rack mount. The accessory box that was shipped with your EQX contains the two wrenches needed to loosen the bolts. Use the 7/16" size wrench to remove the side bolts, and the 9/16" size wrench to remove the bottom bolts.
13. Once the bolts are removed, the EQX can be moved from the pallet and installed in the desired location. Please refer to the EQX user manual for installation and operation instructions.

2.1.3 EQX Router Frames

All units are designed for mounting in standard 19" equipment racks. The depth of the frame is 460mm (18") plus connectors. In addition, allowance must be made to accommodate the large number of cables to be installed at the rear of the frame.



In order to prevent unauthorized access to the power connections, the EQX must be installed in an equipment rack that provides restricted access to the rear of the frame.



The EQX frame must be securely fastened to the equipment rack to prevent tipping.

Power dissipation in all units is low, and cooling is achieved by fan-assisted convection. The I/O modules in the upper and lower section of the EQX frame are independently cooled. Air is drawn into the front of the frame and expelled as hot air from the rear of the frame. The crosspoint modules are also independently cooled with cool air being drawn from the front of the frame and hot air being expelled from the side of the frame. (For further information refer to section 8).



When installed in the equipment rack, ensure that the air flow from the rear and side vents is not blocked or restricted.



Once installed ensure that the EQX frame is connected correctly to Earth/Ground using the Ground terminal on the rear of the EQX frame.

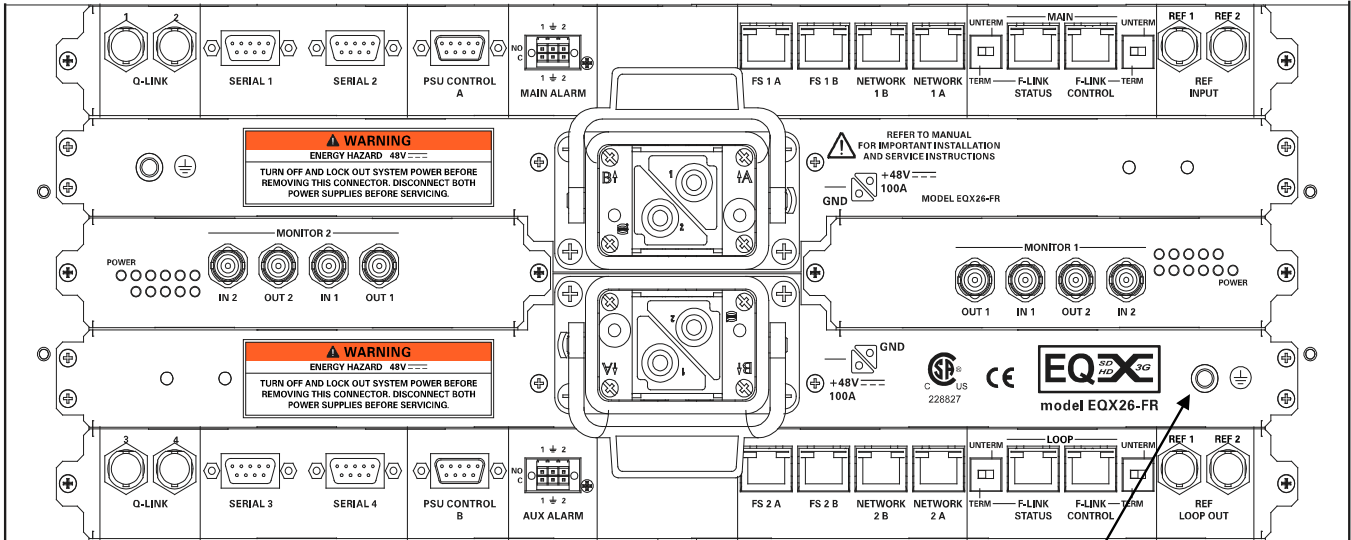

Earth/Ground Stud

Figure 2-3 : EQX Frame Connection

2.2 ELECTRICAL CONNECTIONS

The following is a rear panel view of the EQX's connections:



Figure 2-4 : EQX Rear View (26RU EQX)

2.2.1 Video Inputs and Outputs

The video input and output connections for the EQX are made using one of the standard connectors such as 75Ω BNC, DIN 1.0/2.3, Fiber and X-Link. A high quality coax cable, such as PSF1/3 (TF3304) for SDI video, Belden 8281 or 1694 for HD SDI video or suitable equivalents, should be used for optimum signal performance.



Note: It is both important and good practice that cables are properly supported and not hanging on the connectors as this can put unnecessary stress on the connectors and possibly reduces their working life.

2.2.2 Video Sync (Reference Input)

Standard Definition and High Definition Video routers have a separate reference input that takes any standard analog bi-level or tri-level video signal with standard sync.

2.2.3 Manual Remote Control - Using Q-Link

All EQX routers can be connected to remote control panels by a single coaxial link called Q-link. This link uses standard 75Ω video cables daisy-chained from frame to frame and from panel to panel over a maximum cable length of **500m**. Each end of the link must be terminated in 75Ω.

This daisy-chain method ensures the best transmission quality of the control signals down the cable. Shortcuts that may save cable, such as running stubs to some panels is not recommended as this may under certain circumstances, cause data errors.

The system can support up to 8 devices. Each unit being connected to the Q-Link has its own address switch, which is set up as part of the system configuration.



Note: The installer must fit a 75Ω terminator at each end of the cable.

For further technical information on the manual remote control refer to section 7.

2.3 CONNECTING AN AC POWER SUPPLY

The EQX frame is powered from an external 48V DC source. In applications where you need to power the frame from 100 to 240 VAC sources, you will need to use the EQX external AC to DC power supply.



Figure 2-5 : EQX External Power Supply

The external power supply for the EQX is a single rail, load-sharing design. It is housed within a single 1RU rack-mounting tray (EQX-PS-FR), which carries four power supply modules (EQX-PS), each with their own AC inlet. Power supply modules operate on either 100-115 or 220-240 volts AC at 50 or 60 Hz and automatically sense the input voltage.

The power supply modules can be hot-swapped while the EQX is operational, should one fail.

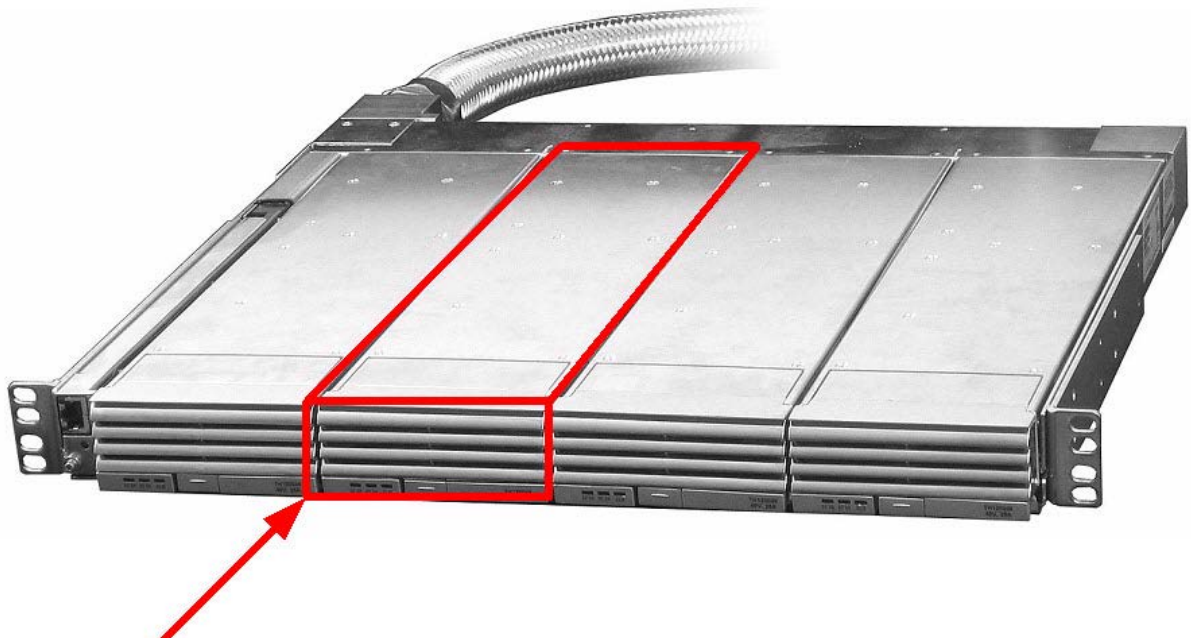

Power Supply Module (single)

Figure 2-6 : EQX External Power Supply – Tray holding 4 modules

A second power supply tray containing 4 power supply modules can be attached (via its own dedicated connector) to the EQX frame to provide full redundant protection. The power supply modules in the second power supply tray must be powered from a different AC mains source to the primary power supply modules, to achieve complete AC supply redundancy.



Note: Some applications require more power supplies. See project designs.



RISK OF ELECTRIC SHOCK: If only one power supply is connected to the EQX frame, the second power supply connector on the rear of the EQX must be fitted with the safety cover to prevent electric shock as shown in Figure 2-6.

Each power supply module delivers up to 1200 watts of power to the EQX. Care must be taken when designing the AC distribution to the power supply so that sufficient AC circuits are available to power each module. When the EQX is operating from a single power supply tray, each module in that tray will draw approximately 13.2 amperes maximum when connected to an 115VAC source, and approximately 7.2 amperes maximum when connected to a 220 VAC source.

Power should be applied by connecting a 3-wire grounding type power supply cord to the IEC320 AC inlets on the rear of the power supply tray. The power cord should be minimum 16 AWG wire size; type SVT marked VW-1, maximum 2.5 m in length.

**WARNING:**

This equipment uses power/mains connectors fitted with safety ground pins. To reduce the risk of electric shock, grounding of the ground pin of the mains plug must be maintained. Once installed ensure that the Power Supply Tray frame is connected correctly to Earth/Ground using the Ground terminal on the rear of the tray.



To completely disconnect this equipment from the AC mains, disconnect the power supply cord plug from the AC receptacle. This equipment may have more than one power supply cord. To reduce the risk of electric shock, disconnect all power supply cords before servicing.

**WARNING:**

Once installed ensure that the Power Supply Tray frame is connected correctly to Earth/Ground using the Ground terminal on the rear of the tray.

Power Supply Earth/Ground Terminal



Figure 2-7 : EQX External Power Supply – Ground Terminal Location

2.4 POWER UP

Power supply comes with an external power switch mounted on a 1RU panel with a mating cable, which has to be plugged into alarm connector at the back of the power tray. When switch is in OFF position all the power modules will be shutdown and when it is in on position it will cause the power modules to power back up. The power modules will start in high fan speed mode and reduce their speed according to the ambient and plant conditions within 10 seconds.

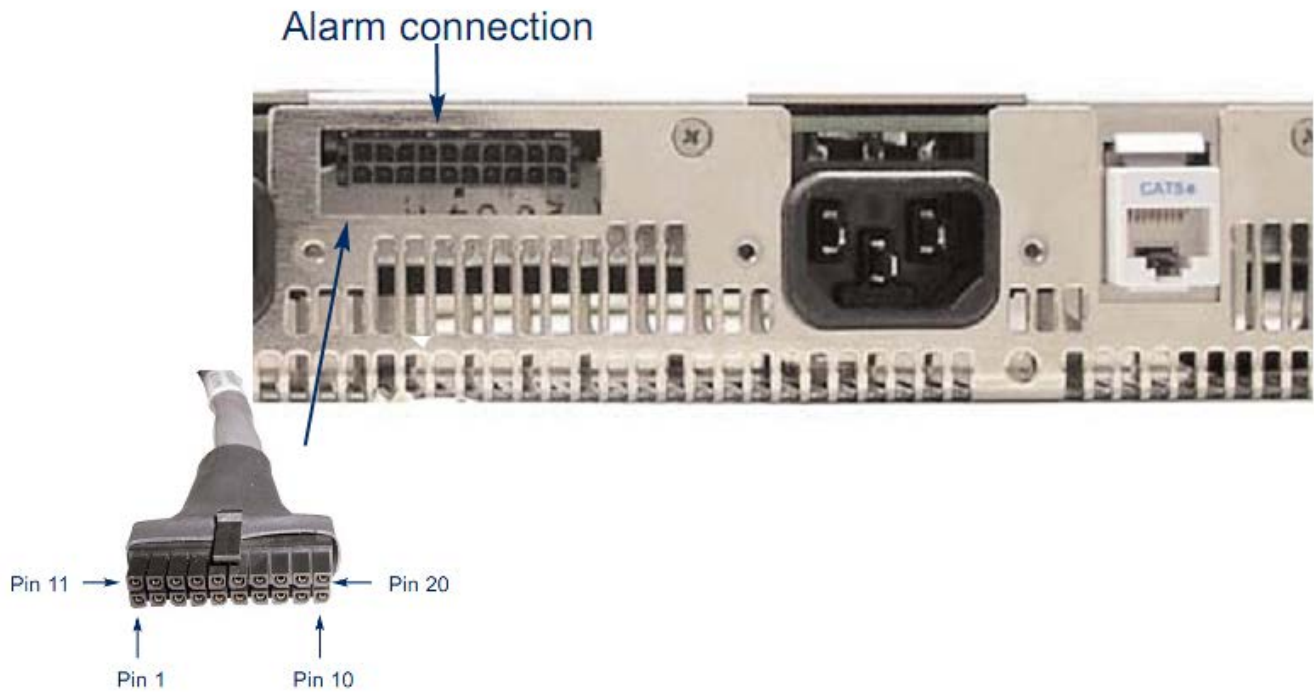

Figure 2-8 : External Power Switch

2.4.1 Power Supply - Key Features

- 1RU 48V DC load sharing power supply frame carrying 4 power supply modules
- Power supply modules can be hot-swapped
- DC input power connections with Anderson connector
- External power switch



Note: If the power switch is unplugged, it will cause the power modules to remain ON or if they are off they will turn ON.

EQX frames come with two types of power connectors, EQX-PS-FR and EQX-PS-FR-B. EQX-PS-FR type power connectors were used in older frames and the DC cable fitted with a lever locking connector to provide a secure connection from the Power Supply to the EQX frames. Shown in Figure 2-9.



Figure 2-9 : EQX External Power Supply – Connection to Older EQX Frames

The EQX-PS-FR-B type power connectors are used in the new frames and the DC cable is secured with retaining screw to any of the four mating connections on the rear of the EQX to provide strain relief. This is shown in Figure 2-10.

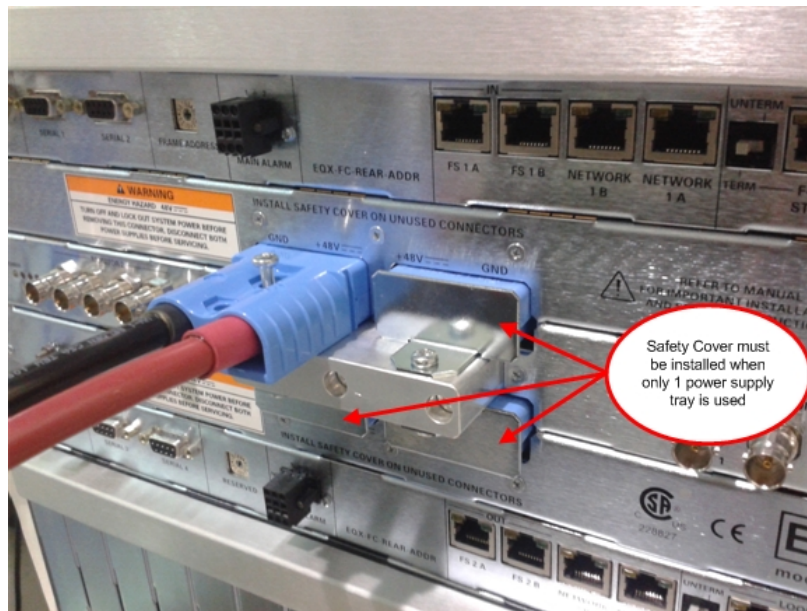

Figure 2-10 : EQX External Power Supply – Connection to New EQX Frames

2.5 GETTING STARTED: SETUP INSTRUCTIONS

The following list outlines the steps that must be taken **before** operating the EQX. Please ensure that you have setup the system according to the guidelines listed below.

1. The correct standard of reference should be wired into the 50Hz and 60Hz reference inputs.
2. Ensure that your PC is running the current version of the Evertz/Quartz WinSetup application.
3. Wire the Ethernet inputs (at least 1B and 2B) into a network switch and make sure they are accessible to your PC.
4. Ensure that a standard "straight-through" serial cable and Evertz Rainbow ribbon cable (WA-S76) are accessible.
5. Reserve seventy-four (74) IP addresses in your IP address structure.
6. Properly wire the router to a patch bay with valid "known-good" test signals and a "known-good" test station or WFM, which is used for monitoring the signals.

This page left intentionally blank

3 FRAME TYPES

A typical EQX platform has the ability to route up to 576x576 signals in a standard 26RU frame, up to 288x288 in a standard 16RU frame and up to 180X180 in a 10 RU frame. EQX platform can be expanded beyond its standard routing capability by adding X-Link expansions to the frame. The most common frame types are as follow:

- EQX10-FR
- EQX10-FR-XLINK
- EQX16-FR
- EQX16-FR-XLINK
- EQX16-FR-XLINK2
- EQX16-FR-XLINK3
- EQX16-FRQT
- EQX16-FRQT-XLINK
- EQX16-FRQT-XLINK2
- EQX16-FRQT-XLINK3
- EQX26-FR
- EQX26-FR-XLINK2
- EQX26-FRQT
- EQX26-FRQT-XLINK2



Note: QT Frames are equipped with quieter FANs and can be ordered based on IO types.

3.1 STANDARD 26RU, 16RU AND 10RU

Standard 26RU frames have the capacity for 576X576 IO's without XLINK expansion, 16RU frames have the capacity of 288X288 IO's without Xlink expansion and standard 10RU frames have the capacity of 180X180 main IO's and 192 Xlink expansion outputs. The standard frames are as follow:

- EQX26-FR
- EQX26-FRQT
- EQX16-FR
- EQX16-FRQT
- EQX10-FR

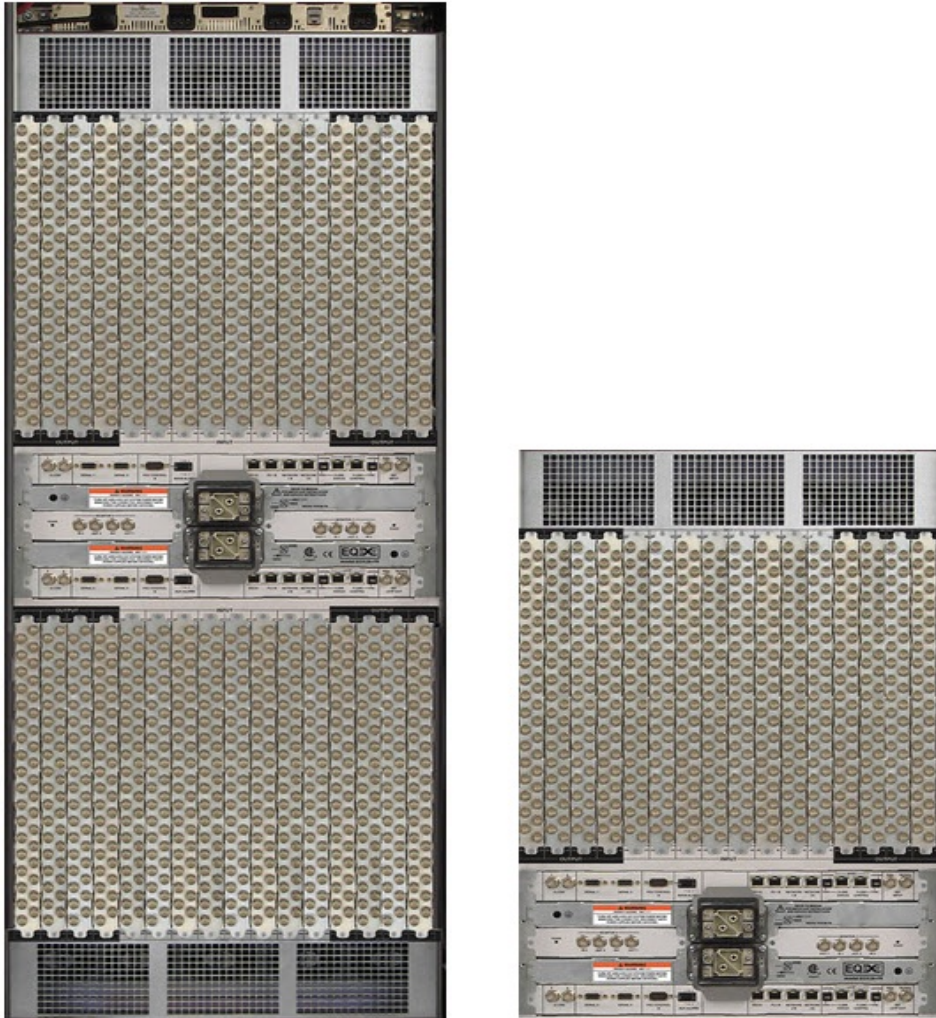

Figure 3-1 : Standard 26RU Frames and 16RU Frames

3.2 26RU WITH XLINK EXPANSION OUTPUTS

26RU frames with Xlink expansions have the capacity for 576X1152 IO. The first 1-576 are main BNC outputs and the remaining 577-1152 are Xlink outputs. The following are 26RU frames with XLINK expansions.

- EQX26-FR-XLINK2
- EQX26-FRQT-XLINK2

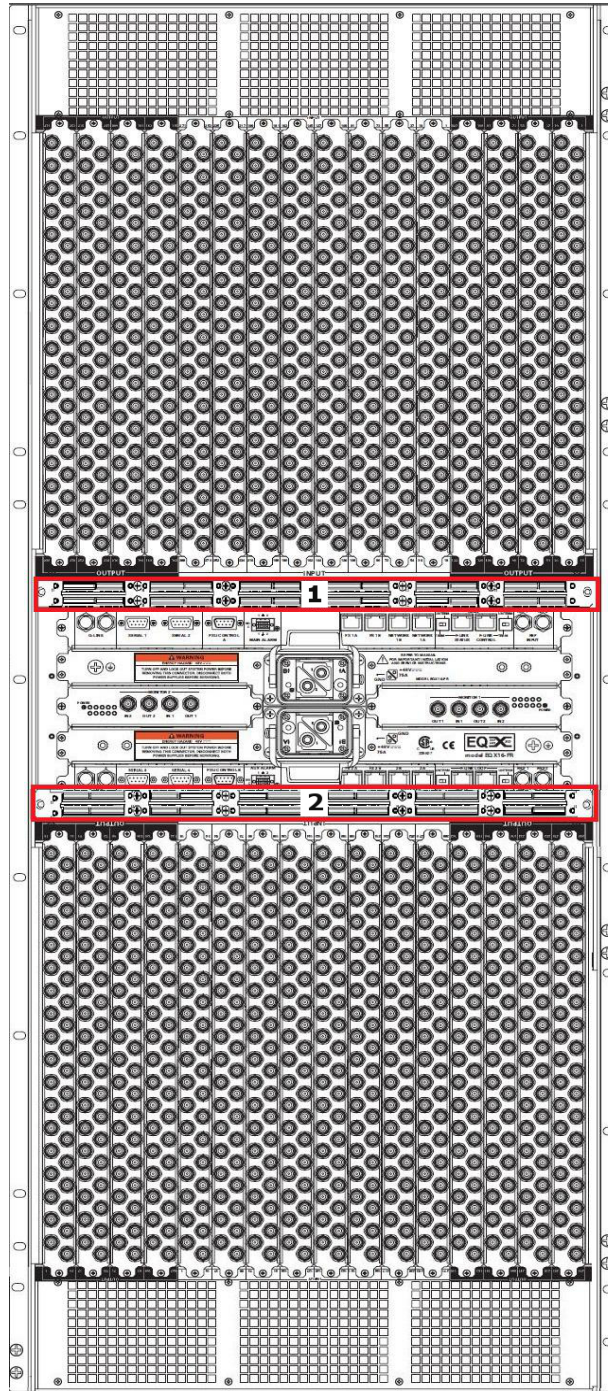

Figure 3-2 : 26RU with XLINK Expansion Outputs

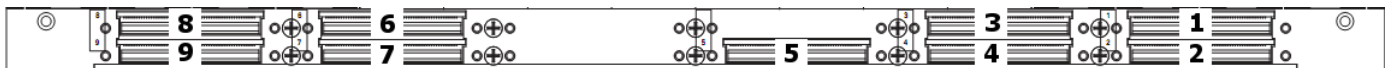

Figure 3-3 : 26 RU Top X-Link connectors

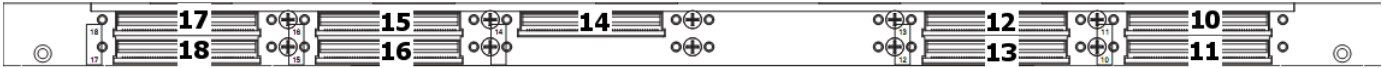

Figure 3-4 : 26 RU Bottom X-Link connectors



Note: Xlink outputs start from 1152-1728 and they are recommended for monitoring purposes only.

3.3 16RU WITH SINGLE XLINK EXPANSION

16RU frames with single Xlink expansion have the capacity for 288X576 IO. Outputs 1-288 are main BNC outputs and the remaining 289-576 are the Xlink outputs. The following are 16RU frames with single XLINK expansions.

- EQX16-FR-XLINK
- EQX16-FRQT-XLINK

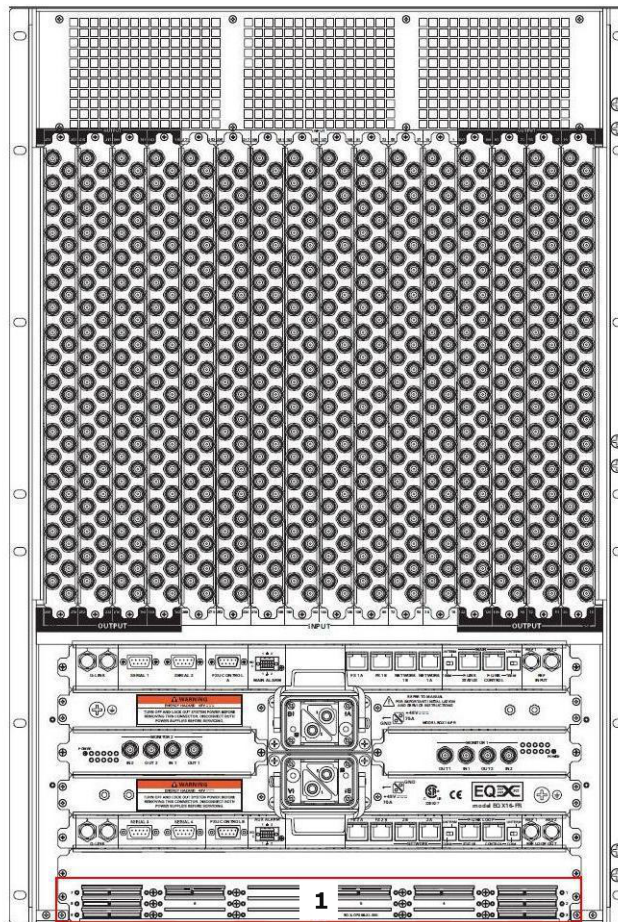

Figure 3-5 : 16RU Frames with Single Xlink Expansion

3.3.1 16RU with Two Xlink Expansions

16RU frames with two Xlink expansions have the capacity for 288X864 IO. Outputs 1-288 are the main BNC outputs and the remaining 289-864 are the Xlink outputs. The following are 16RU frames with Two XLINK expansions.

- EQX16-FR-XLINK2
- EQX16-FRQT-XLINK2

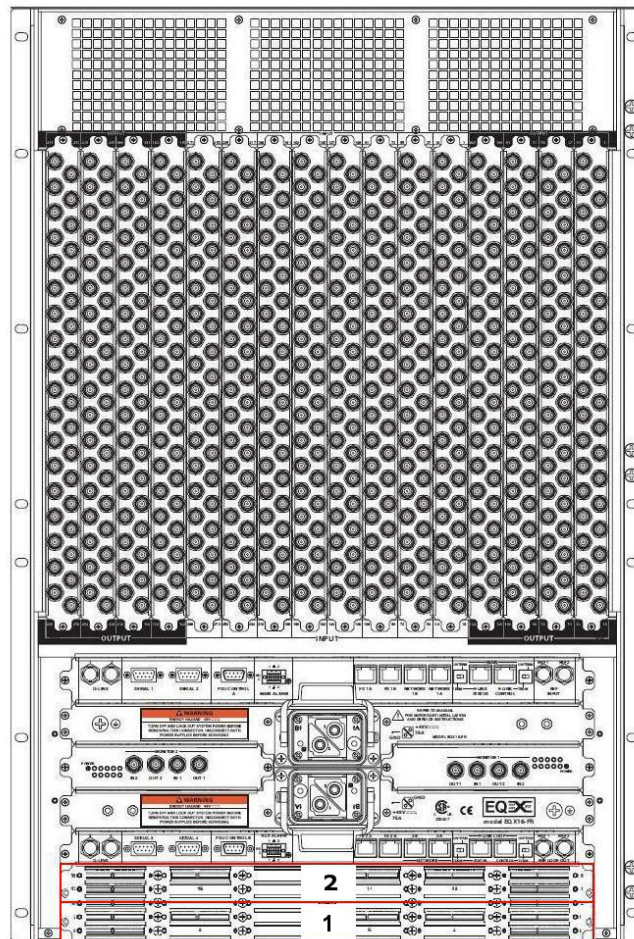

Figure 3-6 : 16RU Frame with Two Xlink Expansions

3.3.2 16RU with three Xlink expansions

16RU frames with three Xlink expansions have the capacity for 288X1152 IO. Outputs 1-288 are the main BNC outputs and the remaining 289-1152 are the Xlink outputs. The following are 16RU frames with Three XLINK expansions.

- EQX16-FR-XLINK3
- EQX16-FRQT-XLINK3

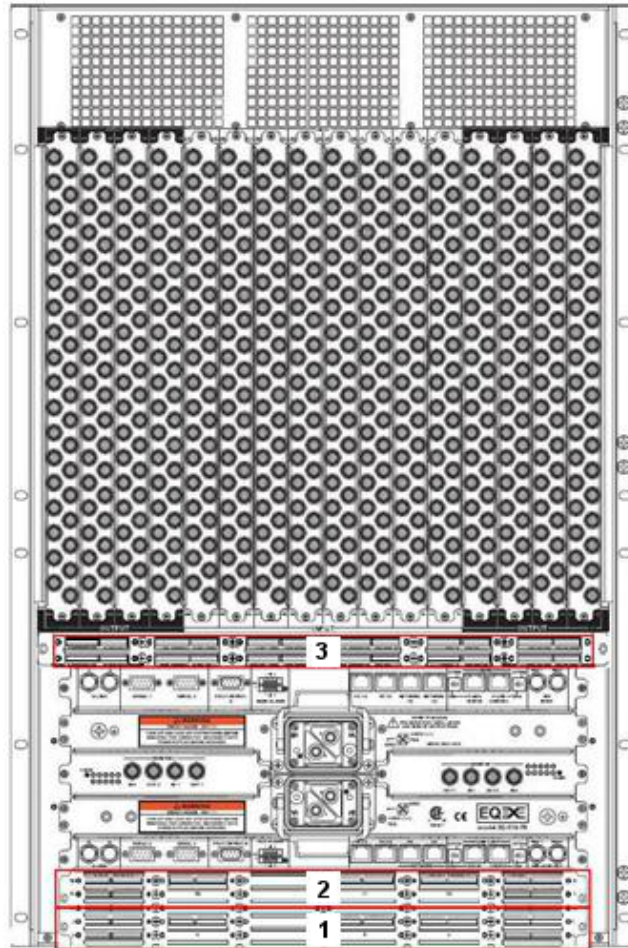

Figure 3-7 : 16RU Frame with Three Xlink Expansions

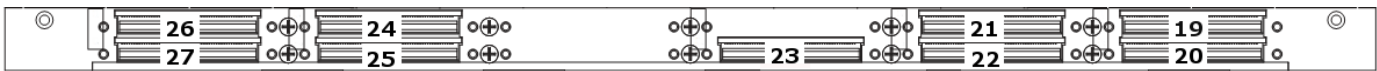

Figure 3-8 : 16RU X-Link expansion 3

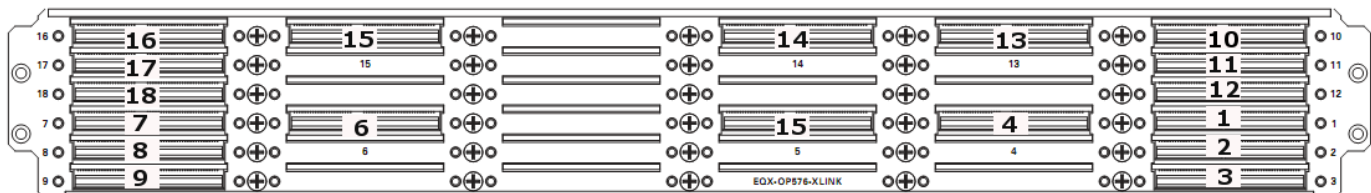

Figure 3-9 : 16RU X-Link expansions 1 and 2

3.4 10RU WITH XLINK EXPANSION OUTPUTS

- EQX10-FR-XLINK

Standard 10RU frames have the capacity for 180X372 I/Os. The first 1-180 are main BNC outputs and the remaining 192 are Xlink outputs. A 10RU frame with Xlink expansions has the capacity for 180X660 IOs. The first 1-180 are main BNC outputs and the remaining 480 are Xlink outputs.

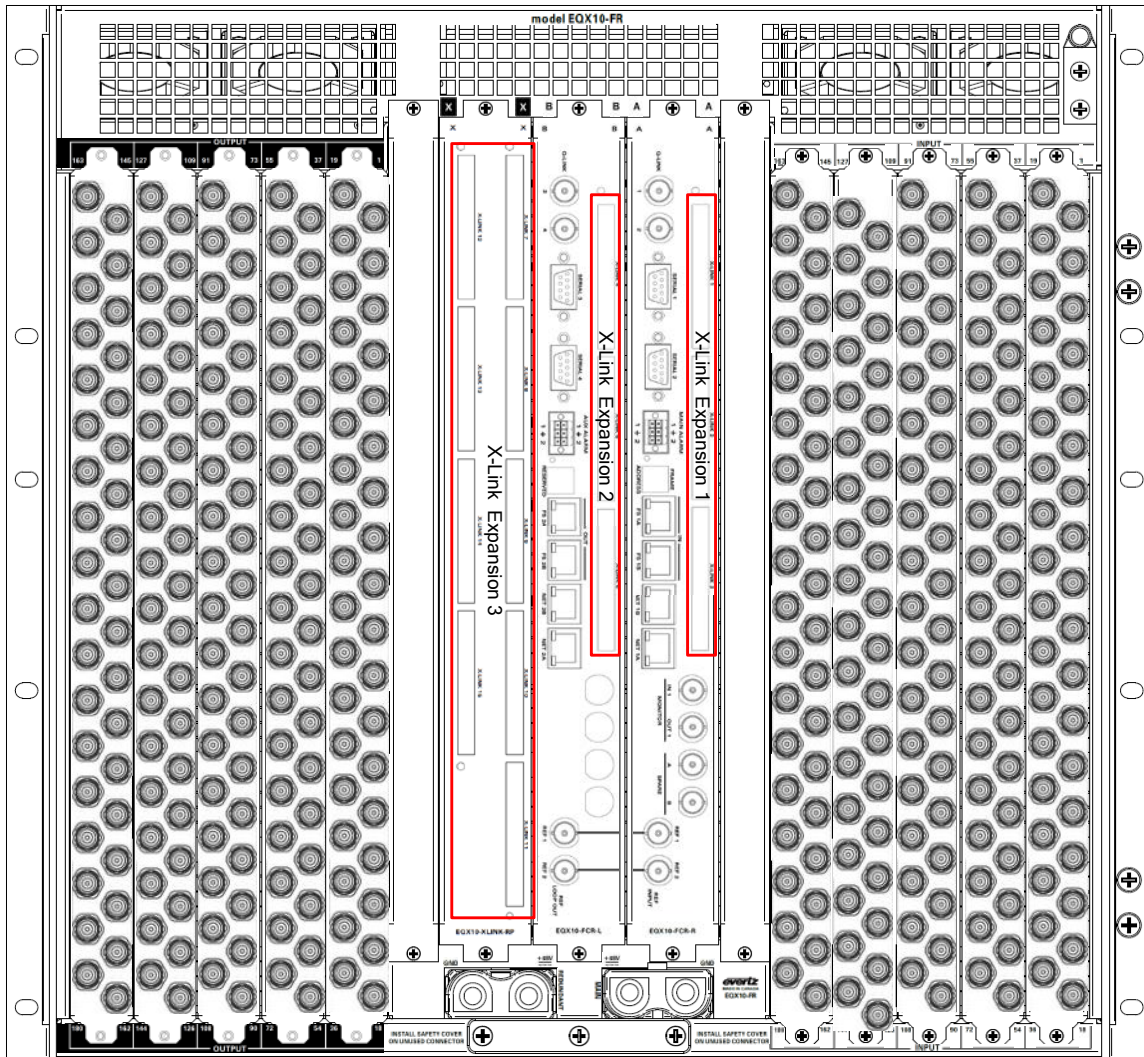

Figure 3-10 : 10RU with Default and optional Xlink Expansion Outputs

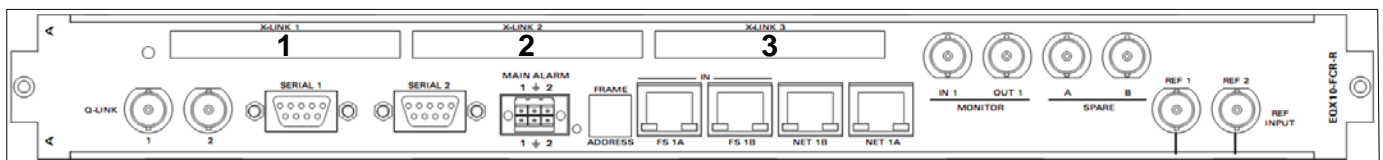

Figure 3-11 : Xlink Expansion 1 Outputs

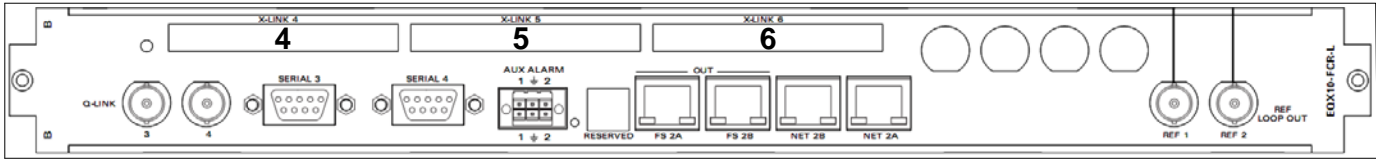

Figure 3-12 : XLINK Expansion 2 Outputs

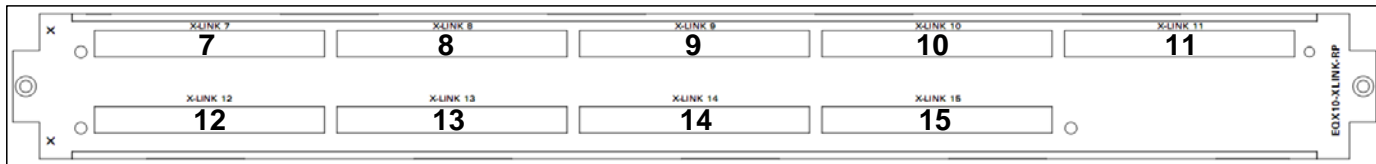

Figure 3-13 : XLINK Expansion 3 Outputs



Note: Xlink outputs are recommended for monitoring purposes only.



Note: Range of Xlink outputs are different based on Map files. See section 10.4 for more information.

3.4.1 X-Link Cover (16RU and 26RU)

Frames with Xlink expansion outputs are always shipped with X-Link protective covers installed; once the Frame/s is racked these covers have to be removed. This is shown in Figure 3-14 and Figure 3-15.

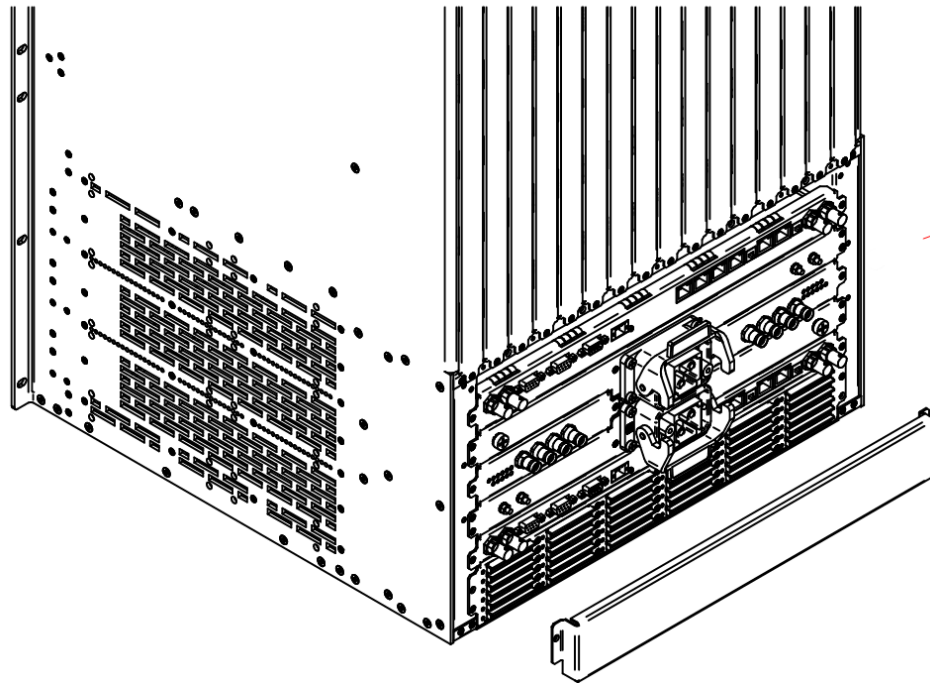

Figure 3-14 : EQX16-FR X-Link Cover

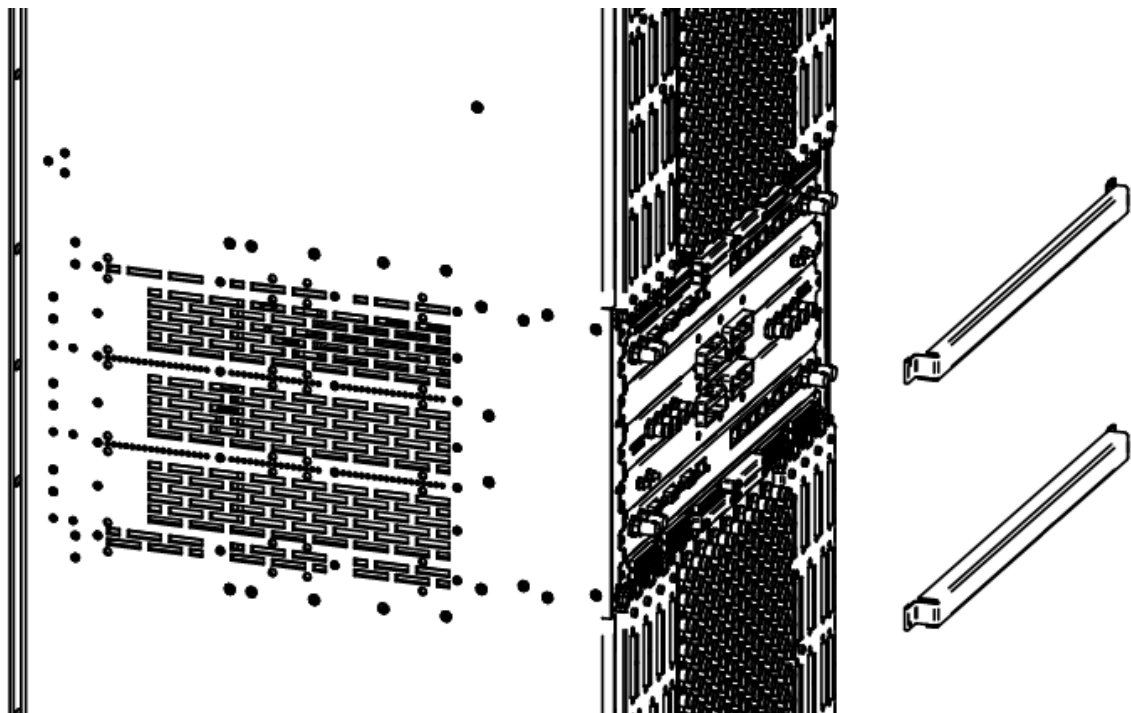

Figure 3-15 : EQX26FR X-Link Cover

4 CONTROL

The standard EQX router includes an internal Frame Controller module, which supports the Q-Link ports, F-Link ports, Ethernet ports and Serial ports that are mounted on the rear of the router.

Remote Control Panel: Any of the Quartz remote control panels can be used with the EQX router connected via Q-Link. This is typically used in conjunction with the EQX server or a 3rd party control system, where these panels are strictly used in emergency situations.

EQX Server: The EQX Server connects via Ethernet and is responsible for managing all connections, Ethernet panels, panels' source and destination names etc.

External Third Party Control: The EQX router can be remotely controlled via an external third party control device, such as an automation system connected to the router's serial port or Ethernet port.

5 SIGNAL PATH MODULES

5.1 EQX-IP18-3G/EQX-G-IP18-3G MODULE

The EQX input module consists of 18 channels of adaptive cable equalization that feeds the incoming signal directly through to the crosspoint modules. On each input the cable equalization facility can be switched On/Off as required.

Each of the input modules supports eighteen (18) digital video inputs via the industry standard BNC connectors mounted on the passive I/O RP.

The EQX router can be loaded with a maximum of 32 input modules providing square and non-square matrix configurations from as small as 18 inputs through to 576 inputs, in increments of 18.

The input module manages digital video with or without embedded audio signals from 3Mb/s through to 3Gb/s.

- SDI (625 and/or 525)
- 3G and HDSDI (720p, 1080i, 1080p, etc)
- DVB-ASI
- SMPTE310

All of the input modules are accessed from the front of the frame and can be replaced while the EQX router is still operational should one of the modules fail. The input modules are air cooled by the fans mounted in the upper and lower half of the frame.

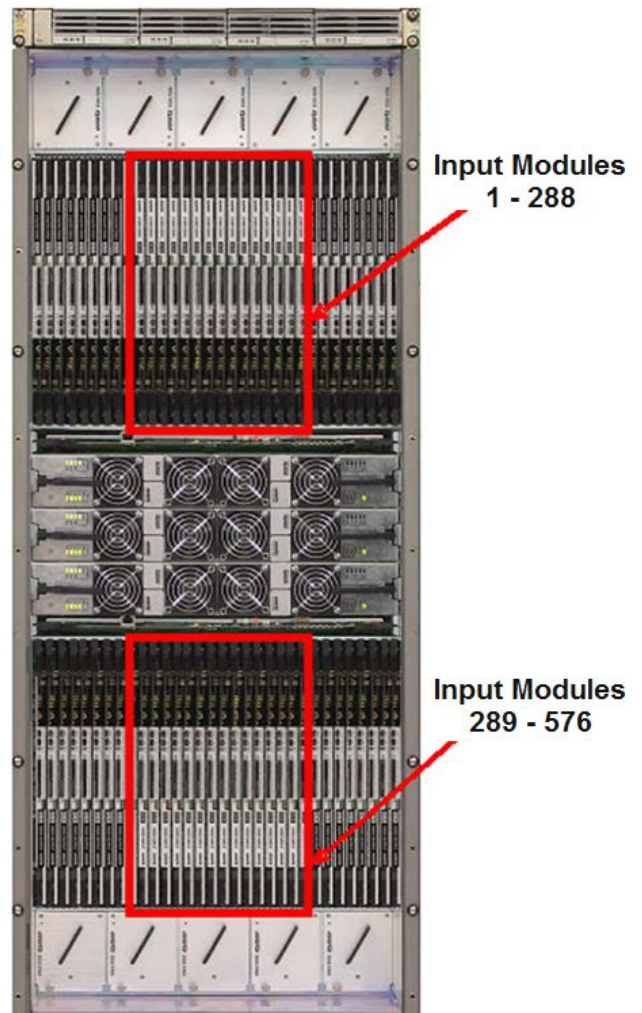

5.1.1 EQX-IP18-3G/EQX-G-IP18-3G - Key Features

- Passes 3G and HD SDI digital video plus Embedded Audio
- Passes SDI digital video plus Embedded Audio
- Supports 3Mb/s to 3Gb/s digital video signals
- Input expansion in increments of 18, from 18 through to 576
- Configurable signal equalization (On/Off)
- Front access to all input modules
- All input modules are hot-swappable
- Fan cooled
- AVM (Audio/Video monitoring)

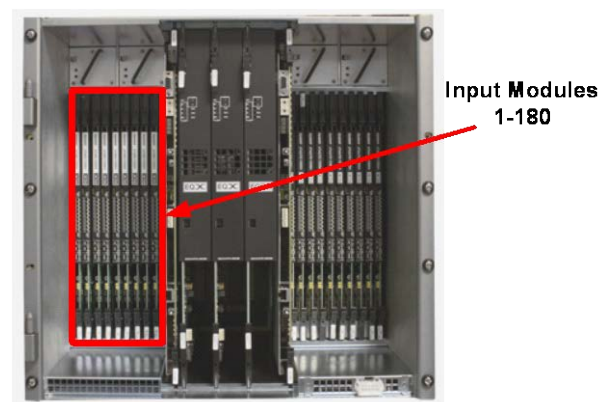



Note: All three frames 26RU, 16RU and 10RU share the same input modules



Figure 5-1 : EQX-IP18-3G (with Air Dam Fitted)



Figure 5-2 : EQX-G-IP18-3G (with Air Dam Fitted)



Figure 5-3 : EQX-IP18-3G – Air Dam Detail



Figure 5-4 : EQX-G-IP18-3G – Air Dam Detail

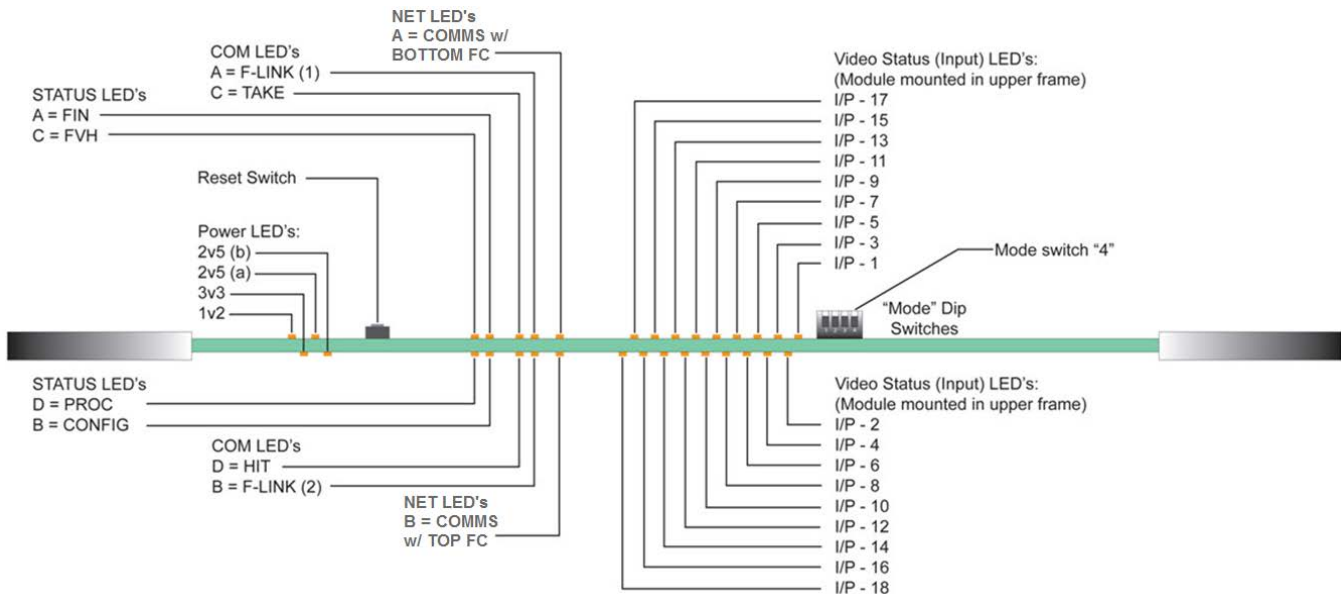

Figure 5-5 : EQX-IP18-3G/EQX-G-IP18-3G – Mounted in Upper Frame (with Air Dam Removed)

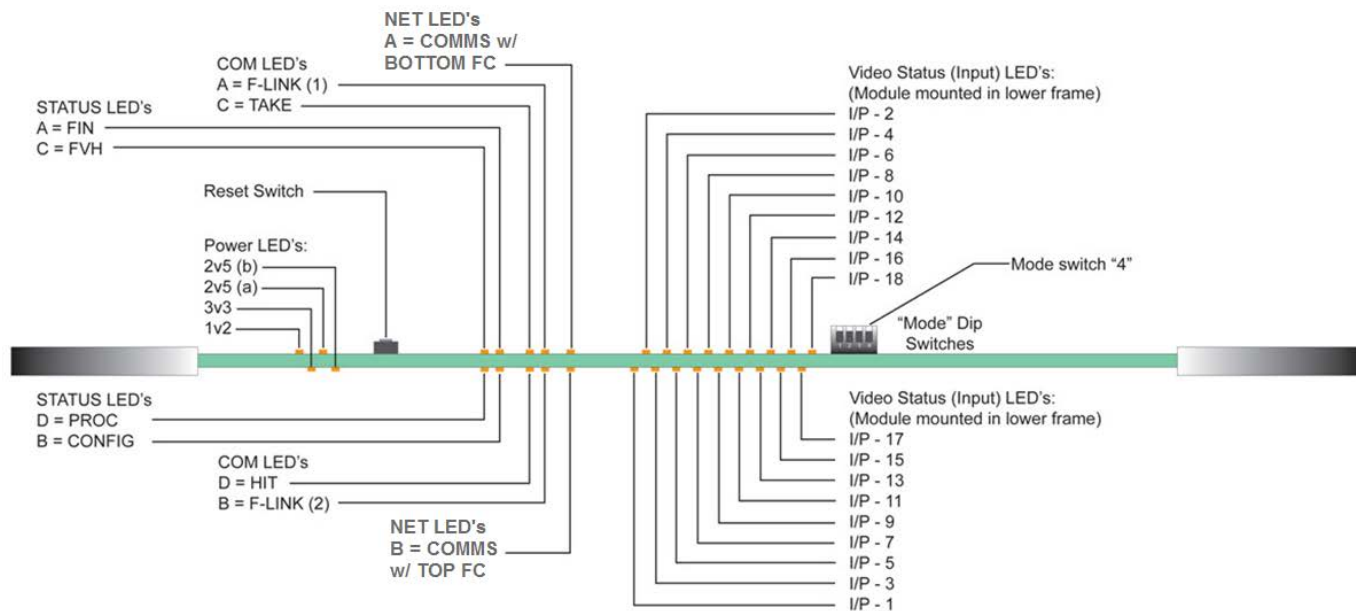

Figure 5-6 : EQX-IP18-3G/EQX-G-IP18-3G – Mounted in Lower Frame (with Air Dam Removed)

POWER LEDs	Colour	Function
1v2	Yellow	1v2 Power rail present
3v3	Yellow	3v3 Power rail present
2v5 (a)	Yellow	2v5 (a) Power rail present
2v5 (b)	Yellow	2v5 (b) Power rail present

STATUS LEDs	Colour	Function
FVH	Green	Single flash toggling with the Proc LED indicates 50Hz while double flash indicates 59.94Hz.
	Red	Steady Red indicates loss of input reference or error.
RP	Red	Indicates that the I/O RP is not present.
CONFIG		Illuminates when all the FPGAs have been configured correctly.
PROC	Green	Flashes at approximately 1 second intervals when the processor is OK and the ref is present. Flashes quickly during FPGA configuration.

STATUS LEDs	Colour	Function
Take	Green	Flashes when the module has performed a "Take".
F-Link (1) "TX"	Green	F-Link TX - Flashes when the F-Link module has transmitted data.
F-Link (2) "RX"	Yellow	F-Link RX - Flashes when any F-Link comms are detected.
	Red	Steady Red indicates error.
F-Link Address Hit	Green	Flashes when there was a valid hit on the module.

NET LEDs	Colour	Function
A	Orange	Bottom FC Ethernet COMMS
B	Green	Top FC Ethernet COMMS

VIDEO LED's	Colour	Function
I/P - 1	Green	Indicates that a signal is present on I/P 1
I/P - 2	Green	Indicates that a signal is present on I/P 2
I/P - 3	Green	Indicates that a signal is present on I/P 3
I/P - 4	Green	Indicates that a signal is present on I/P 4
I/P - 5	Green	Indicates that a signal is present on I/P 5
I/P - 6	Green	Indicates that a signal is present on I/P 6
I/P - 7	Green	Indicates that a signal is present on I/P 7
I/P - 8	Green	Indicates that a signal is present on I/P 8
I/P - 9	Green	Indicates that a signal is present on I/P 9
I/P - 10	Green	Indicates that a signal is present on I/P 10
I/P - 11	Green	Indicates that a signal is present on I/P 11
I/P - 12	Green	Indicates that a signal is present on I/P 12
I/P - 13	Green	Indicates that a signal is present on I/P 13
I/P - 14	Green	Indicates that a signal is present on I/P 14
I/P - 15	Green	Indicates that a signal is present on I/P 15
I/P - 16	Green	Indicates that a signal is present on I/P 16
I/P - 17	Green	Indicates that a signal is present on I/P 17
I/P - 18	Green	Indicates that a signal is present on I/P 18

MODE DIP Switch		
Switch 1	F-Link Baud Rate	(Factory setting UP)
Switch 2	Not Used	(Factory setting UP)
Switch 3	Not Used	(Factory setting = UP)
Switch 4	UP = FVH 50 DOWN = FVH 59.94	(Factory setting = N/A)

Table 5-1 : Component Description of EQX Input Modules



Note: The order of the VIDEO STATUS LEDs is reversed when the Input module is fitted into the lower section of the frame. The LEDs confirm that a signal is present.



Note: Air Dams may vary in shape for different IO modules, but the details on them are the same.

5.1.2 EQX-IP16-3G-2TDM (AUDIO VIDEO INPUT PROCESSOR)

The EQX AVIP module consists of 16 channels of adaptive cable equalization that feeds the incoming signal directly through to the crosspoint modules. On each input the cable equalization facility can be switched On/Off as required.

Each of the AVIP supports sixteen (16) digital video inputs plus two (2) TDM outputs stream via the industry standard BNC connectors mounted on the passive I/O RP.

The EQX router can be loaded with a maximum of 32 AVIP modules providing square and non-square matrix configurations from as small as 16 inputs plus 2 TDM outputs through to 512 physical inputs, in increments of 18.

AVIP module manages digital video with or without embedded audio signals from 3Mb/s through to 3Gb/s.

It de-embeds the audio from all 16 inputs and multiplexes them onto 2 TDM streams. One stream is the main and the other is the redundant. Either TDM stream can be used as the primary since they are identical.

Standards that are supported are listed below:

- SDI (625 and/or 525)
- 3G and HDSDI (720p, 1080i, 1080p, etc)
- DVB-ASI
- SMPTE310

All of the AVIP modules are accessed from the front of the frame and can be replaced while the EQX router is still operational should one of the modules fail. The AVIP modules are air cooled by the fans mounted in the upper and lower half of the frame.

5.1.2.1 AVIP Module - Key Features

- Passes 3G and HD SDI digital video plus Embedded Audio
- Passes SDI digital video plus Embedded Audio
- Ability to de-embed audio from the video and stream over TDM so that it can be routed/processed separately
- Supports 3Mb/s to 3Gb/s digital video signals
- Input expansion in increments of 16 + 2, from 18 through to 512
- Works same as ordinary input module
- Provides SRC (Sample Rate Conversion) option via VLPRO
- Configurable signal equalization (On/Off)
- Front access to all AVIP modules
- All modules are hot-swappable
- Fan cooled

Figure 5-7 below shows the card edge view of AVIP and Table 5-2 gives the description of each component.

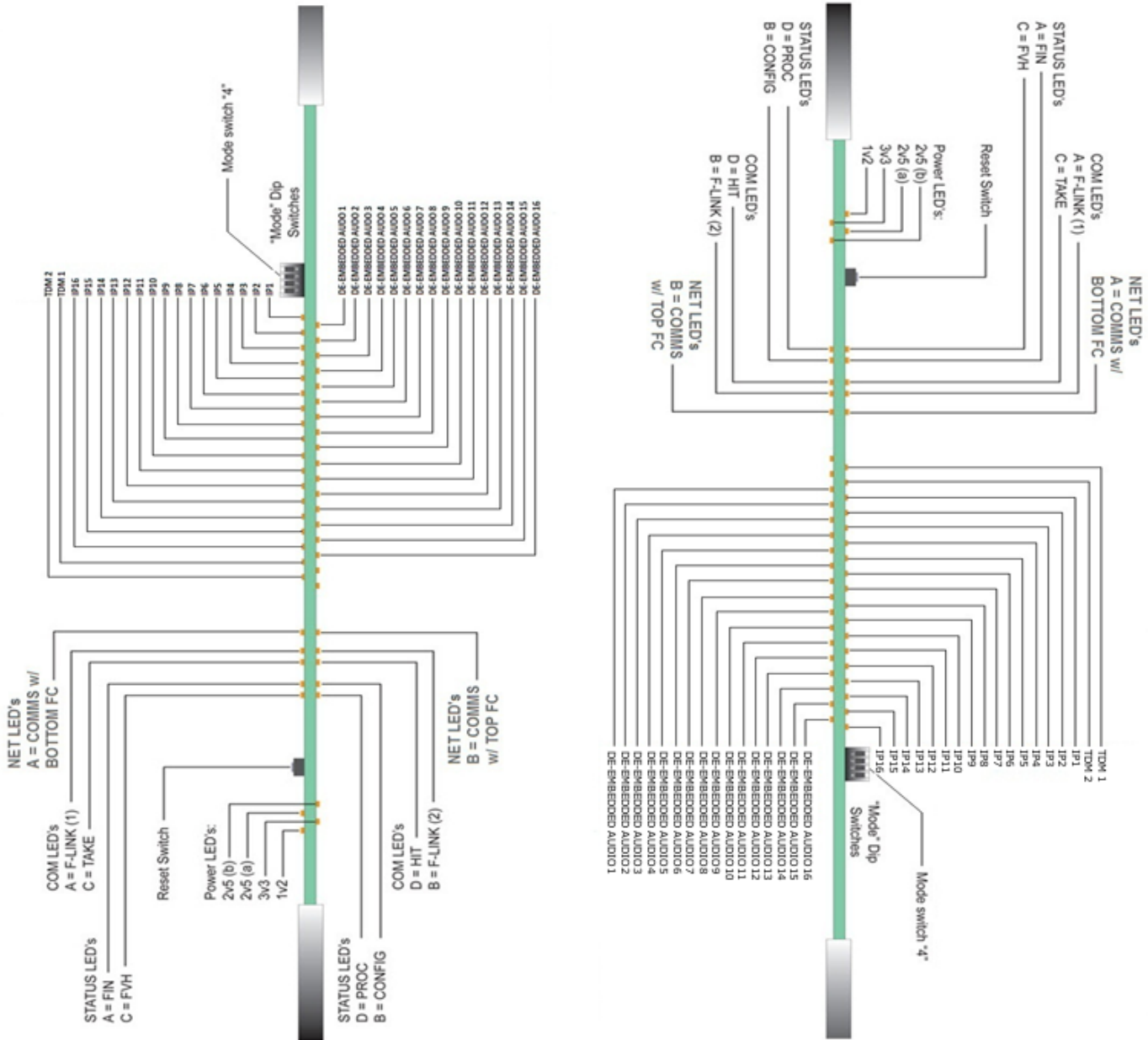

Figure 5-7 : AVIP on the Left mounted in upper frame/ AVIP on the right mounted in the lower frame

The figure below shows the rear view of an EQX frame with two AVIPs and two AVOPs on the top half of the frame and two AVIPs and two AVOPs on the bottom half of the frame. When AVIPs and AVOPs are in the top half of the frame, the last two BNCs are reserved for TDM input and outputs. However, when these cards are in the bottom half, the first two BNCs are reserved for TDM inputs and outputs and the SDI inputs and outputs start from third BNC.

19	1		19	1
Input 19	Input 1		Output 19	Output 1
Input 20	Input 2		Output 20	Output 2
Input 21	Input 3		Output 21	Output 3
Input 22	Input 4		Output 22	Output 4
Input 23	Input 5		Output 23	Output 5
Input 24	Input 6		Output 24	Output 6
Input 25	Input 7		Output 25	Output 7
Input 26	Input 8		Output 26	Output 8
Input 27	Input 9		Output 27	Output 9
Input 28	Input 10		Output 28	Output 10
Input 29	Input 11		Output 29	Output 11
Input 30	Input 12		Output 30	Output 12
Input 31	Input 13		Output 31	Output 13
Input 32	Input 14		Output 32	Output 14
Input 33	Input 15		Output 33	Output 15
Input 34	Input 16		Output 34	Output 16
TDM1 Out	TDM1 Out		TDM1 In	TDM1 In
TDM2 Out	TDM2 Out		TDM2 In	TDM2 In
36	18		36	18
TOP XPT				
MID XPT				
BOT XPT				
307	289		307	289
TDM1 Out	TDM1 Out		TDM1 In	TDM1 In
TDM2 Out	TDM2 Out		TDM2 In	TDM2 In
Input 309	Input 291		Output 309	Output 291
Input 310	Input 292		Output 310	Output 292
Input 311	Input 293		Output 311	Output 293
Input 312	Input 294		Output 312	Output 294
Input 313	Input 295		Output 313	Output 295
Input 314	Input 296		Output 314	Output 296
Input 315	Input 297		Output 315	Output 297
Input 316	Input 298		Output 316	Output 298
Input 317	Input 299		Output 317	Output 299
Input 318	Input 300		Output 318	Output 300
Input 319	Input 301		Output 319	Output 301
Input 320	Input 302		Output 320	Output 302
Input 321	Input 303		Output 321	Output 303
Input 322	Input 304		Output 322	Output 304
Input 323	Input 305		Output 323	Output 305
Input 324	Input 306		Output 324	Output 306
324	306		324	306

Figure 5-8 : Physical input and output of AVIP/AVOP at the back of EQX frame

POWER LEDs	Colour	Function
1v2	Yellow	1v2 Power rail present
3v3	Yellow	3v3 Power rail present
2v5 (a)	Yellow	2v5 (a) Power rail present
2v5 (b)	Yellow	2v5 (b) Power rail present

STATUS LEDs	Colour	Function
FVH	Green	Single flash toggling with the Proc LED indicates 50Hz while double flash indicates 59.94Hz.
	Red	Steady Red indicates loss of input reference or error.
RP	Red	Indicates that the I/O RP is not present.
CONFIG		Illuminates when all the FPGAs have been configured correctly.
PROC	Green	Flashes at approximately 1 second intervals when the processor is OK and the <i>ref</i> is present. Flashes quickly during FPGA configuration.

STATUS LEDs	Colour	Function
Take	Green	Flashes when the module has performed a "Take".
F-Link (1) "TX"	Green	F-Link TX - Flashes when the F-Link module has transmitted data.
F-Link (2) "RX"	Yellow	F-Link RX - Flashes when any F-Link comms are detected.
	Red	Steady Red indicates error.
F-Link Address Hit	Green	Flashes when there was a valid hit on the module.

NET LEDs	Colour	Function
A	Orange	Bottom FC Ethernet COMMS
B	Green	Top FC Ethernet COMMS

VIDEO LED's	Colour	Function
I/P - 1	Green	Indicates that a signal is present on I/P 1
I/P - 2	Green	Indicates that a signal is present on I/P 2
I/P - 3	Green	Indicates that a signal is present on I/P 3
I/P - 4	Green	Indicates that a signal is present on I/P 4
I/P - 5	Green	Indicates that a signal is present on I/P 5
I/P - 6	Green	Indicates that a signal is present on I/P 6
I/P - 7	Green	Indicates that a signal is present on I/P 7
I/P - 8	Green	Indicates that a signal is present on I/P 8
I/P - 9	Green	Indicates that a signal is present on I/P 9
I/P - 10	Green	Indicates that a signal is present on I/P 10
I/P - 11	Green	Indicates that a signal is present on I/P 11
I/P - 12	Green	Indicates that a signal is present on I/P 12
I/P - 13	Green	Indicates that a signal is present on I/P 13
I/P - 14	Green	Indicates that a signal is present on I/P 14
I/P - 15	Green	Indicates that a signal is present on I/P 15
I/P - 16	Green	Indicates that a signal is present on I/P 16
TDM1	Green	Indicates that a TDM signal present
TDM2	Green	Indicate that a TDM signal present

Embedded Audio LED's	Colour	Function
I/P - 1	Green	Indicates breakaway audio on I/P 1
I/P - 2	Green	Indicates breakaway audio on I/P 2
I/P - 3	Green	Indicates breakaway audio on I/P 3
I/P - 4	Green	Indicates breakaway audio on I/P 4
I/P - 5	Green	Indicates breakaway audio on I/P 5
I/P - 6	Green	Indicates breakaway audio on I/P 6
I/P - 7	Green	Indicates breakaway audio on I/P 7
I/P - 8	Green	Indicates breakaway audio on I/P 8
I/P - 9	Green	Indicates breakaway audio on I/P 9
I/P - 10	Green	Indicates breakaway audio on I/P 10
I/P - 11	Green	Indicates breakaway audio on I/P 11
I/P - 12	Green	Indicates breakaway audio on I/P 12
I/P - 13	Green	Indicates breakaway audio on I/P 13
I/P - 14	Green	Indicates breakaway audio on I/P 14
I/P - 15	Green	Indicates breakaway audio on I/P 15
I/P - 16	Green	Indicates breakaway audio on I/P 16

Table 5-2 : Component Description Of EQX AVIP Modules



Note: TDM1 and TMD2 are the copy of each other (redundant channel).



Note: The order of the VIDEO STATUS LEDs is reversed when the module is fitted into the lower section of the frame. The LEDs confirm that a signal is present.

5.1.3 EQX-IP18-3G-F1 MODULE

The EQX fiber input module consists of 18 channels of adaptive cable equalization that feeds the incoming fiber optic signal through SFPs to the crosspoint modules. On each input the cable equalization facility can be switched On/Off as required.

Each of the input modules supports eighteen (18) optical inputs via 9 dual channel SFPs mounted on the active input RP.

The EQX router can be loaded with a maximum of 32 fiber input modules providing square and non-square matrix configurations from as small as 18 inputs through to 576 physical inputs, in increments of 18.

Fiber input module manages optic signals with or without embedded audio from 3Mb/s through to 3Gb/s.

All of the fiber input modules are accessed from the front of the frame and can be replaced while the EQX router is still operational should one of the modules fail. The fiber input modules are air cooled by the fans mounted in the upper and lower half of the frame.

Fiber input module converts optical signals to electrical signals with or without embedded audio from 3Mb/s through to 3Gb/s.

Standards that are supported are listed below:

- SDI (625 and/or 525)
- 3G and HDSDI (720p, 1080i, 1080p, etc)
- DVB-ASI
- SMPTE310

5.1.3.1 EQX-IP18-3G-F1 - Key Features

- Accepts optical signals
- Converts optical signal to electrical signal
- Passes 3G and HD SDI digital video plus Embedded Audio
- Passes SDI digital video plus Embedded Audio
- Supports 3Mb/s to 3Gb/s digital video signals
- Input expansion in increments of 18, from 18 through to 576
- Configurable signal equalization (On/Off)
- Front access to all input modules
- All modules are hot-swappable
- Fan cooled

5.1.4 EQX-IP16AD-3G-2TDM-F1 (FIBER AUDIO VIDEO INPUT PROCESSOR)

The EQX Fiber AVIP module consists of 16 channels of adaptive cable equalization that feeds the incoming fiber optic signal through SFPs to the crosspoint modules. On each input the cable equalization facility can be switched On/Off as required.

Each of the fiber AVIP modules supports sixteen (16) optical inputs via dual channel SFPs plus two (2) TDM stream outputs via the industry standard BNC connectors mounted on the active input RP.

The EQX router can be loaded with a maximum of 32 Fiber AVIP modules providing square and non-square matrix configurations from as small as 16 inputs plus 2 TDM outputs through to 512 physical inputs, in increments of 18.

Fiber AVIP module converts optical signals to electrical signals with or without embedded audio from 3Mb/s through to 3Gb/s.

It de-embeds the audio from all 16 optical inputs and multiplexes them onto 2 TDM streams. One stream is the main and the other is the redundant. Either TDM stream can be used as the primary since they are identical.

Standards that are supported are listed below:

- SDI (625 and/or 525)
- 3G and HDSI (720p, 1080i, 1080p, etc)
- DVB-ASI
- SMPTE310

All of the Fiber AVIP modules are accessed from the front of the frame and can be replaced while the EQX router is still operational should one of the modules fail. The Fiber AVIP modules are air cooled by the fans mounted in the upper and lower half of the frame.

5.1.4.1 EQX-IP16AD-3G-2TDM-F1 - Key Features

- Accepts optical signal
- Converts optical signal to electrical signal
- Passes 3G and HD SDI digital video plus Embedded Audio
- Passes SDI digital video plus Embedded Audio
- Ability to de-embed audio from the video and stream over TDM so that it can be routed/processed separately
- Supports 3Mb/s to 3Gb/s digital video signals
- Input expansion in increments of 16 + 2, from 18 through to 512
- Works same as ordinary fiber input module
- Provides SRC (Sample Rate Conversion) option via VLPRO
- Configurable signal equalization (On/Off)
- Front access to all AVIP modules
- All modules are hot-swappable
- Fan cooled



Note: The card edge view for Fiber input is the same as the normal input module and the card edge view for Fiber AVIP is the same as the normal AVIP module.

5.1.5 Fiber Optic Inputs

The EQX router is able to accept Fiber Optic inputs when ordered with the optional Fiber Optic input modules. These modules utilize an “SFP” module (Small Form-Factor Pluggable). Each SFP for the Fiber Optic input module is a dual channel RECEIVER. This means Optical signals can be wired as coaxial signals, where all inputs are wired to one type of module and all outputs are wired to another. The Input SFP (or receiver SFP) is called SFP1R-2 and can accept signals from 3Mb/s to 3Gb/s depending on the type of input module that they are mated with.

- The SFP1R-2 supports SMPTE 259M, SMPTE 344M, SMPTE 292M and SMPTE 424M and other data rates
- The SFP1R-2 is hot swappable, and is inserted and removed without the need for specialized tools
- RoHS compliant
- Operating temperature range: 0°C to 70°C
- 56.5mm x 13.4mm x 8.6mm standard SFP Package
- Each signal is on an individual connector of type LC
- Monitoring capability over serial or VLPRO



Figure 5-9 : SFP1R-2 Module

5.1.6 EQX-IP18FSAD-3G

The EQX-IP18FSAD-3G is an 18 channel EQX input module that can frame sync video and de-embed the audio as the standard option. This module is designed to re-time a SMPTE292M or SMPTE 259M input to a local reference signal. When necessary, frames are repeated or dropped to maintain the synchronization.

This module has the ability to loop back the 18 synched inputs to 18 outputs within it.

EQX-FK-AE

EQX-FK-AE a licensed feature, which will provide the ability of re-embedding audio to video using the TDM input connectors.

EQX-FK-DSP

EQX-FK-DSP is another licensed feature which will provide the ability to adjust gain, invert phase and mute mono audio channels. Each mono channel also contains a quad-input mixer in the processing path. The audio can be mixed from TDM input, Pre-sync and Post-sync sources into a single mono channel.

The EQX router can be loaded with a maximum of 32 FS modules providing square and non-square matrix configurations from as small as 18 inputs plus 2 TDM outputs through to 576 physical inputs, in increments of 18. Each module will also have 18 loop output plus 2 TDM inputs.

Standards that are supported are listed below:

- SDI (625 and/or 525)
- 3G and HDSDI (720p, 1080i, 1080p, etc)
- DVB-ASI
- SMPTE310

All of the FS modules are accessed from the front of the frame and can be replaced while the EQX router is still operational should one of the modules fail. The FS modules are air cooled by the fans mounted in the upper and lower half of the frame.

5.1.6.1 EQX-IP18FSAD-3G Modules Key Features

- Synchronizes most of the video standards
- Ability to de-embed audio from the video and stream over TDM so that it can be routed/processed separately
- Ability to re-embed audio to the video from TDM stream.
- Ability to process and mix the signal
- Up to 12 additional frames of delay can be added
- Frame sync can be bypassed
- 18 synched loop outputs plus two TDM inputs
- Output phase adjustment with respect to reference
- Can be set to freeze on the last good frame or go to black on video loss
- Syncs four groups of audio and re-embeds them
- Input expansion in increments of 18 + 2, from 18 through to 576
- Front access to all FS-AVIP modules
- All modules are hot-swappable
- Fan cooled

5.1.7 EQX-IP18AD-3G

EQX-IP18AD-3G module consists of 18 channels of adaptive cable equalization that feeds the incoming signal directly through to the crosspoint modules. On each input the cable equalization facility can be switched On/Off as required.

Each of the AVIP supports eighteen (18) digital video inputs plus two (2) TDM outputs stream via Mini DIN connectors mounted on the passive Input RP. Also, this module has eighteen (18) DA outputs plus two (2) TDM inputs.



Note: TDM inputs are for future use. The 1-18 outputs are the DA of 1-18 input respectively.

The EQX router can be loaded with a maximum of 32 AVIP modules providing square and non-square matrix configurations from as small as 18 inputs plus 2 TDM outputs through to 576 physical inputs, in increments of 18.

AVIP module manages digital video with or without embedded audio signals from 3Mb/s through to 3Gb/s. It de-embeds the audio from all 18 inputs and multiplexes them onto 2 TDM streams. One stream is the main and the other is the redundant. Either TDM stream can be used as the primary since they are identical.

Standards that are supported are listed below:

- SDI (625 and/or 525)
- 3G and HDSDI (720p, 1080i, 1080p, etc)
- DVB-ASI
- SMPTE310

All of the modules are accessed from the front of the frame and can be replaced while the EQX router is still operational should one of the modules fail. The AVIP modules are air cooled by the fans mounted in the upper and lower half of the frame.

5.1.7.1 EQX-IP18AD-3G Modules Key Features

- Passes 3G and HD SDI digital video plus Embedded Audio
- Passes SDI digital video plus Embedded Audio
- Ability to de-embed audio from the video and stream over TDM so that it can be routed/processed separately
- 18 loop outputs plus two TDM inputs
- Input expansion in increments of 18 + 2, from 18 through to 576
- Front access to all FS-AVIP modules
- All modules are hot-swappable
- Fan cooled



Note: EQX-IP18FS/AD-3G modules are configured by VLPRO; refer to section 14 For more information.

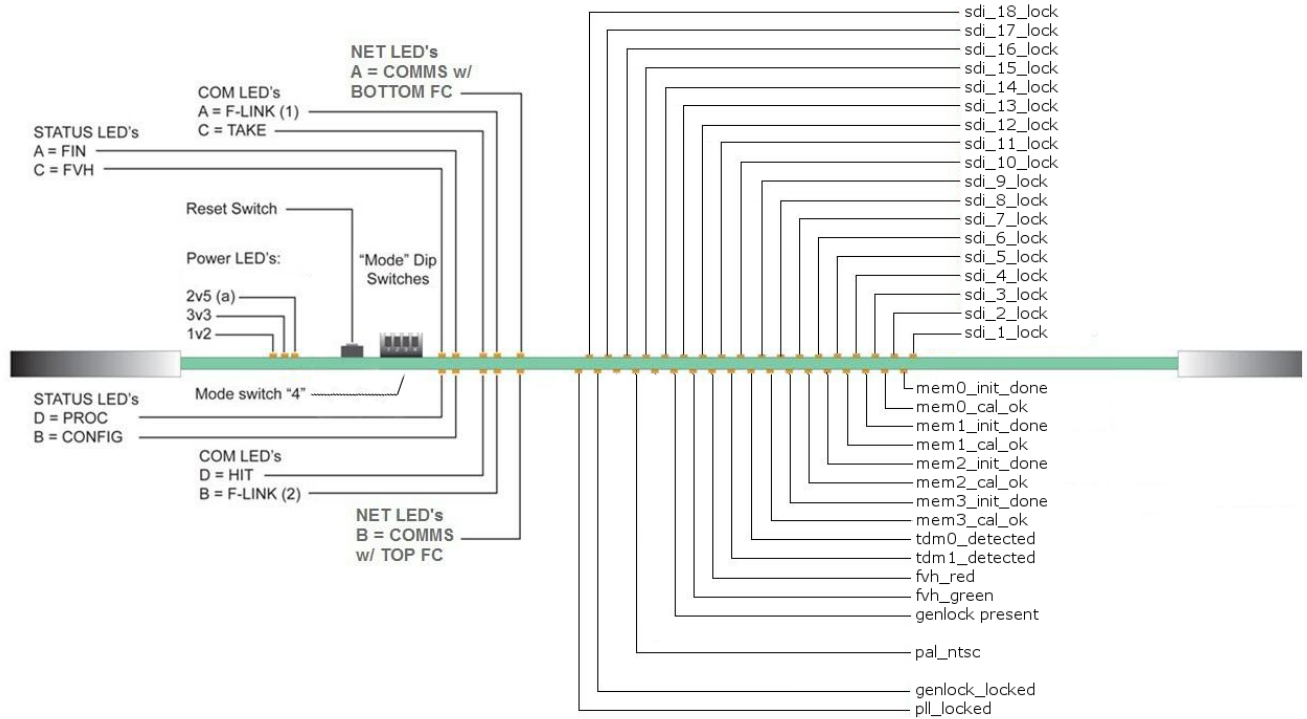

Figure 5-10 : EQX-IP18FS/AD-3G – Mounted in Upper Frame (with Air Dam Removed)

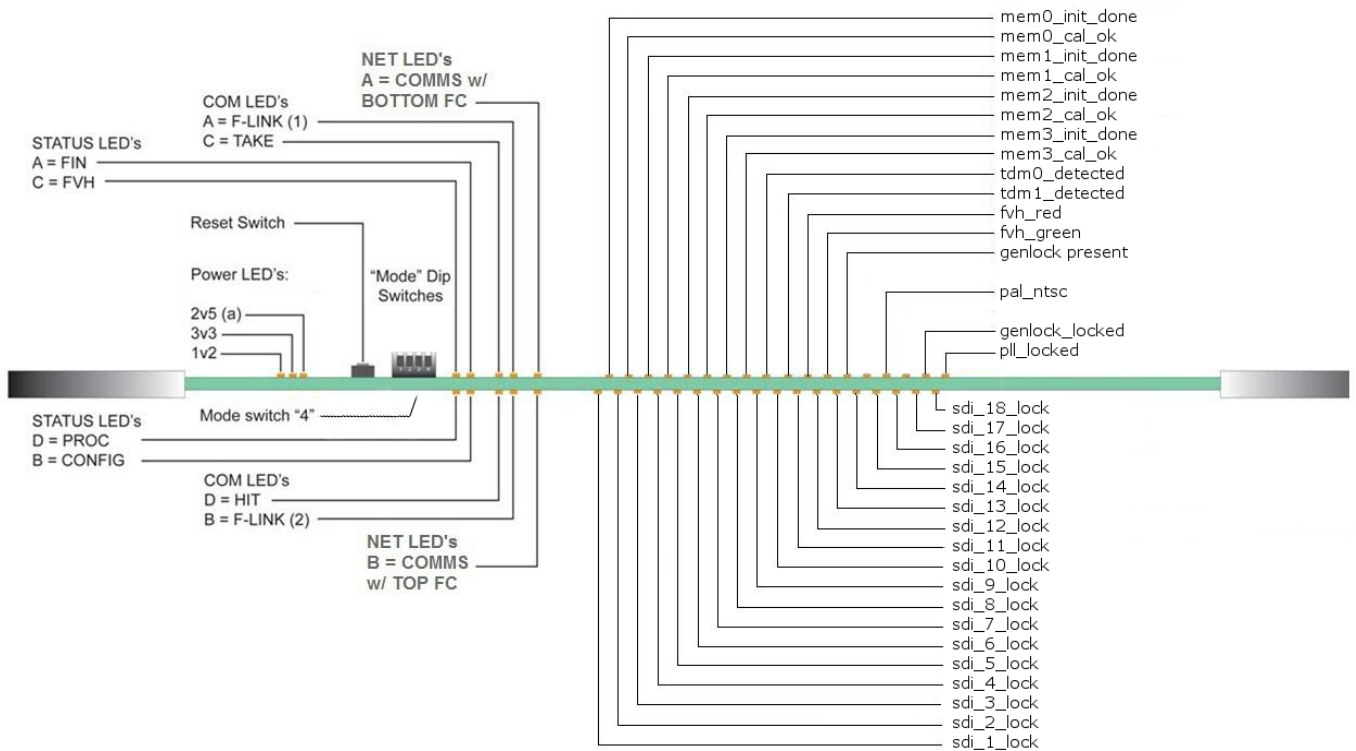

Figure 5-11 : EQX-IP18FS/AD-3G – Mounted in Lower Frame (with Air Dam Removed)

POWER LEDs	Colour	Function
1v2	Yellow	1v2 Power rail present
3v3	Yellow	3v3 Power rail present
2v5 (a)	Yellow	2v5 (a) Power rail present

STATUS LEDs	Colour	Function
FVH	Green	Single flash toggling with the Proc LED indicates 50Hz while double flash indicates 59.94Hz.
	Red	Steady Red indicates loss of input reference or error.
RP	Red	Indicates that the I/O RP is not present.
CONFIG		Illuminates when all the FPGAs have been configured correctly.
PROC	Green	Flashes at approximately 1 second intervals when the processor is OK and the <i>ref</i> is present. Flashes quickly during FPGA configuration.

STATUS LEDs	Colour	Function
Take	Green	Flashes when the module has performed a "Take".
F-Link (1) "TX"	Green	F-Link TX - Flashes when the F-Link module has transmitted data.
F-Link (2) "RX"	Yellow	F-Link RX - Flashes when any F-Link comms are detected.
	Red	Steady Red indicates error.
F-Link Address Hit	Green	Flashes when there was a valid hit on the module.

NET LEDs	Colour	Function
A	Orange	Bottom FC Ethernet COMMS
B	Green	Top FC Ethernet COMMS

VIDEO LED's	Colour	Function
I/P - 1	Green	Indicates that a signal is present on I/P 1
I/P - 2	Green	Indicates that a signal is present on I/P 2
I/P - 3	Green	Indicates that a signal is present on I/P 3
I/P - 4	Green	Indicates that a signal is present on I/P 4
I/P - 5	Green	Indicates that a signal is present on I/P 5
I/P - 6	Green	Indicates that a signal is present on I/P 6
I/P - 7	Green	Indicates that a signal is present on I/P 7
I/P - 8	Green	Indicates that a signal is present on I/P 8
I/P - 9	Green	Indicates that a signal is present on I/P 9
I/P - 10	Green	Indicates that a signal is present on I/P 10
I/P - 11	Green	Indicates that a signal is present on I/P 11
I/P - 12	Green	Indicates that a signal is present on I/P 12
I/P - 13	Green	Indicates that a signal is present on I/P 13
I/P - 14	Green	Indicates that a signal is present on I/P 14
I/P - 15	Green	Indicates that a signal is present on I/P 15
I/P - 16	Green	Indicates that a signal is present on I/P 16
I/P - 17	Green	Indicates that a signal is present on I/P 17
I/P - 18	Green	Indicates that a signal is present on I/P 18

Embedded Audio LED's	Colour	Function
Mem0_init_done	Green	Indicates memory 0 is initialized
Mem0_cal_ok	Green	Indicates memory 0 is calibrated
Mem1_init_done	Green	Indicates memory 1 is initialized
Mem1_cal_ok	Green	Indicates memory 1 is calibrated
Mem2_init_done	Green	Indicates memory 2 is initialized
Mem2_cal_ok	Green	Indicates memory 2 is calibrated
Mem3_init_done	Green	Indicates memory 3 is initialized
Mem3_cal_ok	Green	Indicates memory 3 is calibrated
Tdm0_detected	Green	Indicates breakaway audio on I/P 9
Tdm1_detected	Green	Indicates breakaway audio on I/P 10
Fvh_red	Green	Indicates if proper reference is not connected
Fvh_green	Green	Indicates if proper reference is connected
Genlock present	Green	Indicates the presence of genlock
PAL_NTSC	Green	Indicates whether the reference is PAL or NTSC
Genlock Lock	Green	Indicates if the module is locked to reference
PLL Lock		Indicates the PLL lock

Table 5-3 : LED Description Of EQX-IP18AD-3G Modules

5.2 26RU AND 16RU EQX CROSSPOINT MODULE

The EQX router has provisions for three different crosspoint modules 576X576, 576x288 and 288X288. Each crosspoint switches 576, 576 and 288 inputs through to 576, 288 and 288 outputs respectively.

The upper location houses the crosspoint module that provides the switching for outputs 1-288 (the upper section of the frame). The lower location provides the switching for outputs 289-576 (the lower section of the frame).

The Back-up crosspoint module, which is fitted into the middle location, provides full protection in the case of a failed route(s). The switch over to the back-up crosspoint can be performed manually or automatically. In the event of a failure only the faulty route(s) needs to be switched over to the back-up crosspoint. The new route(s) can be checked before the switch is made through the output monitoring facility.

All of the crosspoint modules are accessed from the front of the frame and can be replaced while the EQX router is still operational should one of the modules fail. The back-up crosspoint provides continued full operation while a main crosspoint module is being replaced.

The crosspoint modules are air cooled by the fan modules that are mounted onto the front of the crosspoint assemblies.

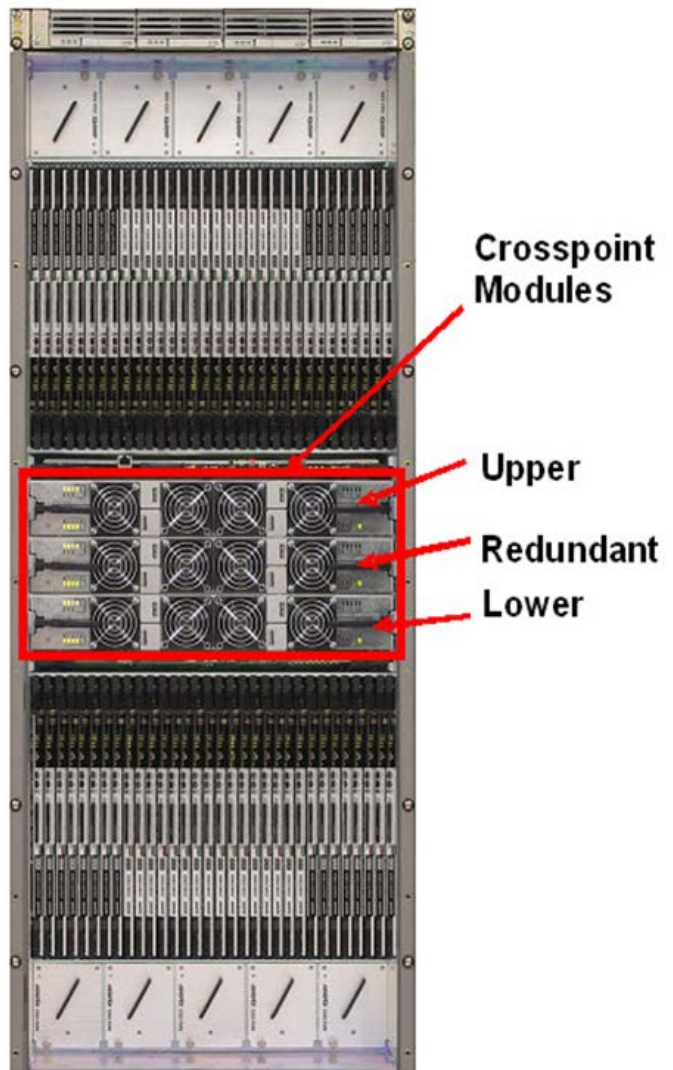

5.2.1 EQX-XPT 576X576

This crosspoint module switches 576 inputs through to 576 outputs. If the crosspoint is fitted in the upper location, it will provide switching for 1-288 main outputs and 288 X-Link outputs.

If it is fitted in the middle location, it will provide full redundancy for outputs 1-576. If it is fitted in the lower location it will provide switching for 289-576 main output and 288 X-Link outputs.

5.2.2 EQX-XPT 576X288

This crosspoint module switches 576 inputs through to 288 outputs. If the crosspoint is fitted in the upper location, it will provide switching for 1-288 main outputs and with X-Link outputs. If it is fitted in the middle location, it will provide shared redundancy for outputs 1-576. If it is fitted in the lower location it will provide switching for 289-576 main output with no X-Link outputs.

5.2.3 EQX-XPT 288X288

This crosspoint can only be fitted in a 16RU frame and it switches 288 inputs through to 288 outputs. If it is fitted in the upper location, it will provide switching for 1-288 main outputs. If it is fitted in the middle location, it will provide either full redundancy for 1-288 or 288 outputs for X-Link. If it is fitted in the lower location, it will provide 288 X-Link outputs only.



Note: X-Link outputs depending on the hardware type and Map file loaded.



Note: Crosspoints modules for 26RU and 16RU frames are not compatible with 10RU frame

5.2.4 Crosspoint - Key Features

- Front access to all crosspoint modules
- All crosspoint modules are hot-swappable
- All crosspoint modules are independently fan cooled

Figure 5-12 below shows the view of a crosspoint and Table 5-4 gives the description of each LED.

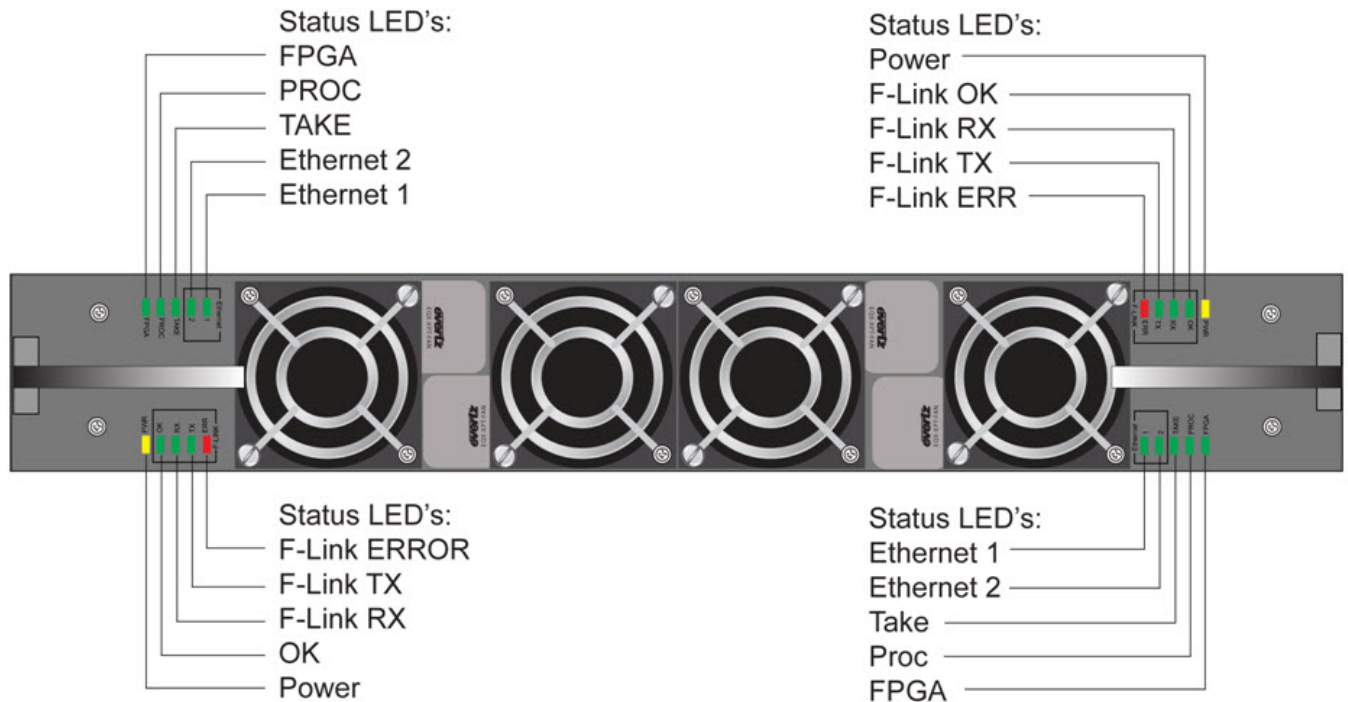

Figure 5-12 : EQX-XPT-288X288/576X288

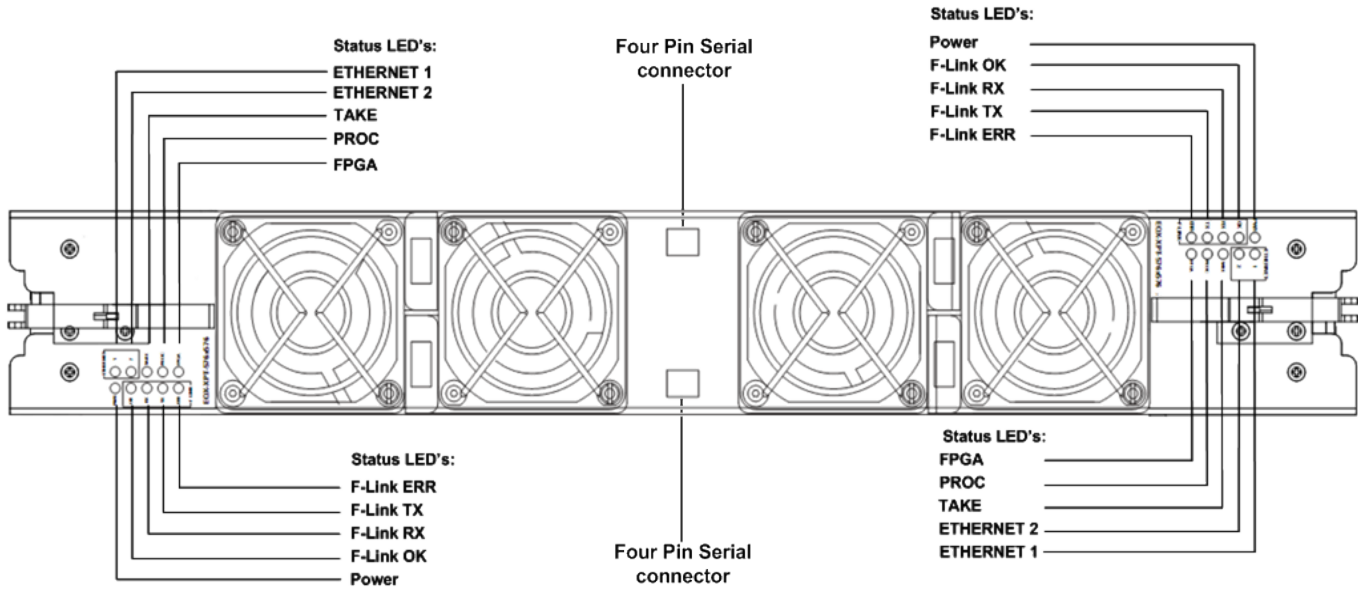

Figure 5-13 : EQX-XPT-576X576

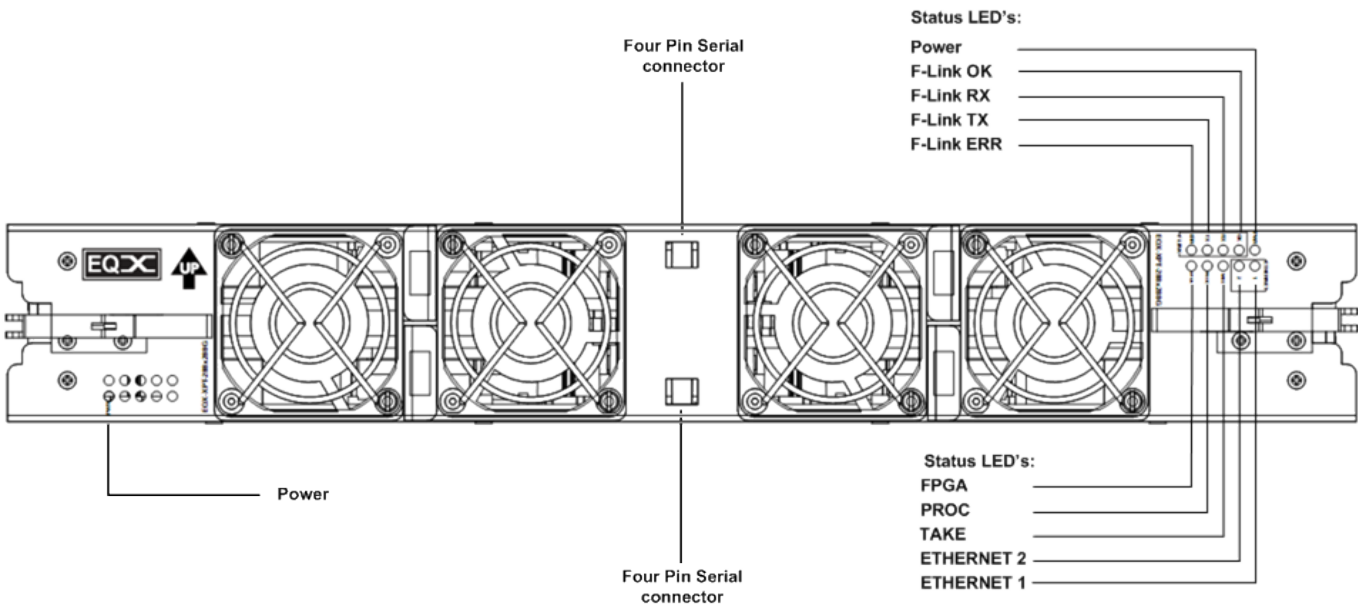

Figure 5-14 : EQX-XPTG-288X288

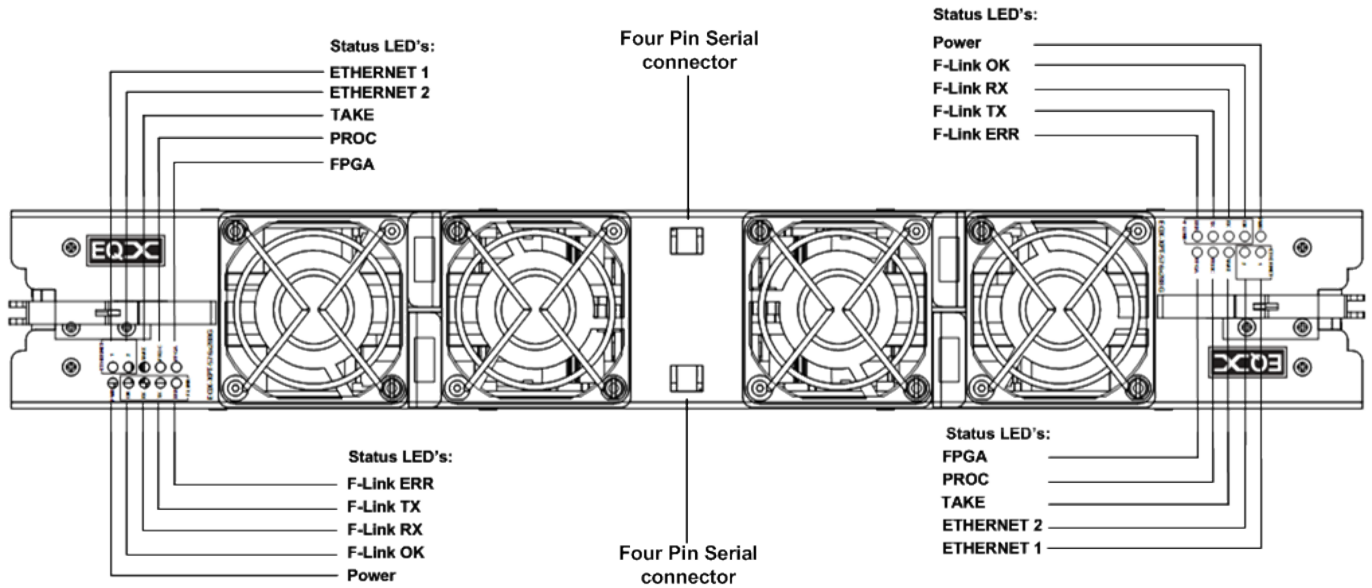

Figure 5-15 : EQX-XPTG-576X576/576X288

LED	Function
Power	Power rail present.
F-Link OK	Flashes when there is a valid hit on the module.
F-Link Rx	Flashes when there is any F-Link comms detected.
F-Link Tx	Flashes when the module has transmitted F-Link data.
F-Link Error	Flashes when the module receives F-Link data that was deemed to be erroneous (bad checksum)
Ethernet (1)	Rx - Flashes when Ethernet data is transmitted. Tx – Flashes when Ethernet data is received
Ethernet (2)	Rx - Flashes when Ethernet data is transmitted. Tx – Flashes when Ethernet data is received
Take	Flashes when the module has performed a “Take”
Proc	Flashes at approximately 1second intervals when the processor is OK. Flashes quickly during FPGA configuration.
FPGA	Illuminates when all the FPGAs have been configured correctly.

Table 5-4 : LED Description Of Crosspoint Modules

This page left intentionally blank

6 10RU EQX CROSSPOINT MODULE

The EQX router has provision for one type crosspoint modules 180X288. This crosspoint switches 180 inputs through to 288 outputs.

The Left location houses the crosspoint module that provides the switching for main and Xlink outputs 1-288. The Right location provides the switching for 288 expansion Xlink outputs.

The Redundant crosspoint module, which is fitted into the middle location, provides full protection in the case of a failed route(s). The switch over to the back-up crosspoint can be performed manually or automatically. In the event of a failure only the faulty route(s) needs to be switched over to the back-up crosspoint. The new route(s) can be checked before the switch is made through the output monitoring facility. This crosspoint also provides outputs for Xlink expansion outputs

All of the crosspoint modules are accessed from the front of the frame and can be replaced while the EQX router is still operational should one of the modules fail. The back-up crosspoint provides continued full operation while a main crosspoint module is being replaced.

The crosspoint modules are air cooled by the fan modules that are mounted onto the front of the crosspoint assemblies.

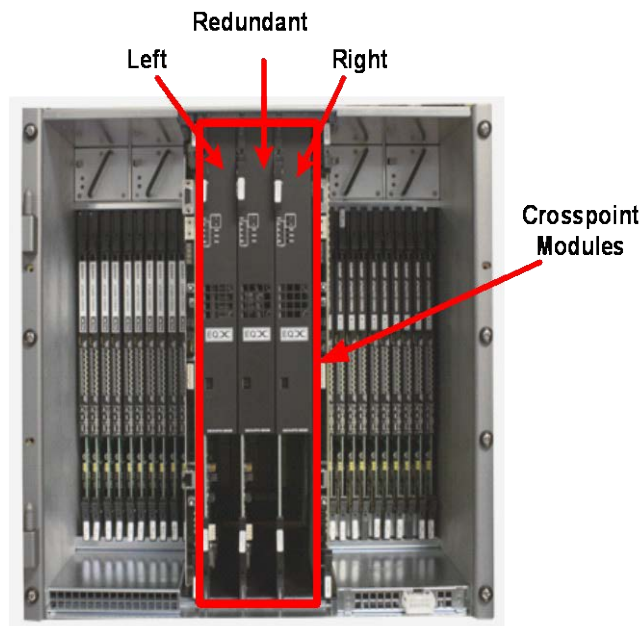

6.1 EQX10-XPTG 180X288

This crosspoint module switches 180 inputs through to 288 outputs. If the crosspoint is fitted in the Left location, it will provide switching for 1-180 main outputs and 96 X-Link outputs.

If it is fitted in the middle location, it will provide full redundancy for outputs 1-180 and 96 X-Link outputs and if it is fitted in the Right location it will provide 288 X-Link outputs.

6.1.1 Crosspoint - Key Features

- Front access to all crosspoint modules
- All crosspoint modules are hot-swappable
- All crosspoint modules are independently fan cooled

Figure 6-1 below shows the view of a crosspoint and Table 6-1 gives the description of each LED.

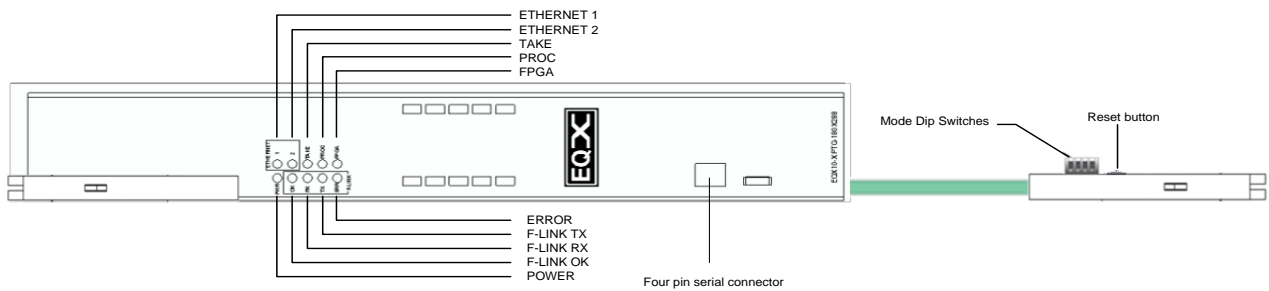

Figure 6-1 : EQX10-XPTG-180X288

LED	Function
Power	Power rail present.
F-Link OK	Flashes when there is a valid hit on the module.
F-Link Rx	Flashes when there is any F-Link comms detected.
F-Link Tx	Flashes when the module has transmitted F-Link data.
F-Link Error	Flashes when the module receives F-Link data that was deemed to be erroneous (bad checksum)
Ethernet (1)	Rx - Flashes when Ethernet data is transmitted. Tx – Flashes when Ethernet data is received
Ethernet (2)	Rx - Flashes when Ethernet data is transmitted. Tx – Flashes when Ethernet data is received
Take	Flashes when the module has performed a “Take”
Proc	Flashes at approximately 1second intervals when the processor is OK. Flashes quickly during FPGA configuration.
FPGA	Illuminates when all the FPGAs have been configured correctly.

Table 6-1 : LED Description Of EQX10-XPTG-180X288



Note: Crosspoint modules for 10RU frame are not compatible with 26RU and 16RU frames.

6.2 EQX10-XPTG-ADMX10

EQX10-XPTG-ADMX10 integrates a 10 port ADMX audio TDM crosspoint with a traditional video crosspoint. This module will provide 10 internal TDM inputs and 10 internal TDM outputs for AVIP and AVOP or will provide 10 external TDM inputs and 10 external TDM outputs via X-Link connector. On top of that this module switches 180 video inputs through to 288 video outputs. If the crosspoint is fitted in the Left location, it will provide switching for 1-180 main outputs and 64 X-Link outputs. If the optional redundant crosspoint is fitted in the middle, it will provide full redundancy for audio and video plus additional 64 X-Link outputs.

+AX5

+ AX5 is a licensed feature which will provide additional 5 inputs and 5 outputs to be used as external TDM or MADI

6.2.1 Crosspoint - Key Features

- Front access to all crosspoint modules
- All crosspoint modules are hot-swappable
- All crosspoint modules are independently fan cooled
- Independent Audio and Video routing

Figure 6-2 below shows the view of a crosspoint and Table 6-2 gives the description of each LED.

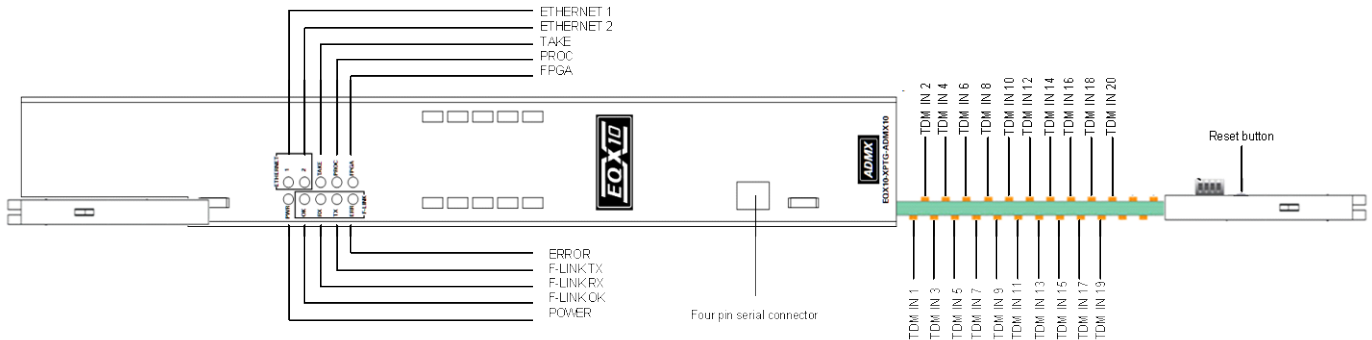

Figure 6-2 : EQX10-XPTG-ADMX10

LED	Function
Power	Power rail present.
F-Link OK	Flashes when there is a valid hit on the module.
F-Link Rx	Flashes when there is any F-Link comms detected.
F-Link Tx	Flashes when the module has transmitted F-Link data.
F-Link Error	Flashes when the module receives F-Link data that was deemed to be erroneous (bad checksum)
Ethernet (1)	Rx - Flashes when Ethernet data is transmitted. Tx – Flashes when Ethernet data is received
Ethernet (2)	Rx - Flashes when Ethernet data is transmitted. Tx – Flashes when Ethernet data is received
Take	Flashes when the module has performed a “Take”

Proc	Flashes at approximately 1second intervals when the processor is OK. Flashes quickly during FPGA configuration.
FPGA	Illuminates when all the FPGAs have been configured correctly.
TDM In 1 -10	Indicat if valid TDN sources are connected to these ports
TDM In 11-20	Reserved

Table 6-2 : LED Description Of EQX10-XPTG-ADMX10

6.3 EQX-OP18-3G/EQX-G-OP18-3G MODULES

The EQX output module comprises of 18 reclocked output channels fed from the crosspoint modules. On each output the reclocking facility can be switched On/Off or switched into ASI bypass mode as required.

Like the input module, each of the output modules support eighteen (18) digital video outputs using industry standard BNC connectors mounted on the passive I/O RP.

The EQX router can be loaded with a maximum of 32 output modules, providing square and non-square configurations from 18 outputs through to 576 outputs in increments of 18.

The output module manages digital video and embedded audio signals from 3Mb/s through to 3Gb/s. The following are supported:

- SDI (625 and/or 525)
- HDSDI (720p, 1080i, 1080p etc)
- DVB-ASI
- SMPTE310

All of the output modules are accessed from the front of the frame and can be replaced while the EQX router is still operational should one of the modules fail. The output modules are air cooled by the fans mounted in the upper and lower half of the frame.

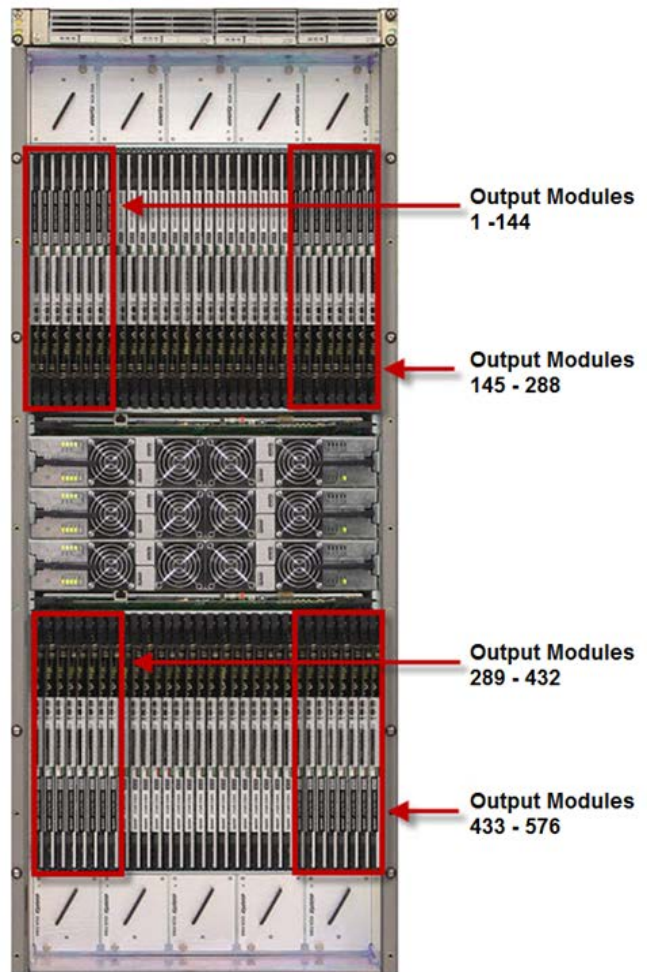

6.3.1 Supported Reclocking Signal Frequencies

SD/HD Output Module:

Conforms to SMPTE 259M and SMPTE 292M

Signals supported: 143Mb/s (D2 @ 59.94Hz)
 177Mb/s (D2 @ 50Hz)
 270Mb/s
 360Mb/s
 540Mb/s
 1483.5Mb/s @ 59.94Hz
 1485Mb/s @ 50Hz

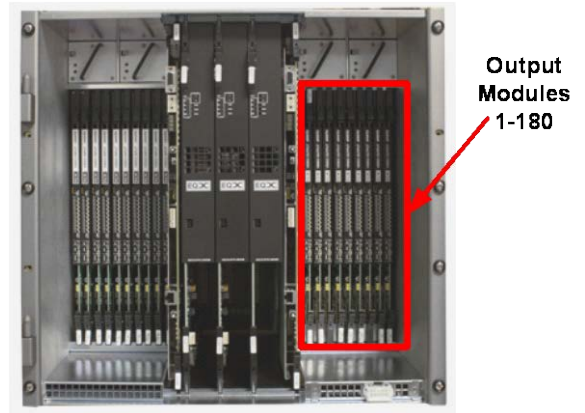

SD/HD/3G Output Module:

Conforms to SMPTE 259M-C, SMPTE 292M and SMPTE 424M

Signals supported: 270Mb/s
 1483.5Mb/s @ 59.94Hz
 1485Mb/s @ 50Hz
 2967Mb/s @ 59.94Hz
 2970Mb/s @ 50 Hz



Note: Some 270Mb/s ASI signals occasionally can cause a Reclocker to incorrectly set to a 177Mb/s signal frequency. To prevent this from happening set the “177” option to “Disable” in the WinSetup application and download this new configuration to the EQX router.



Note: All three frames 26RU, 16RU and 10RU share the same output modules

6.3.2 EQX-OP18-3G/ EQX-G-OP18-3G - Key Features

- Passes 3G and HD SDI digital video plus Embedded Audio
- Passes SDI digital video plus Embedded Audio
- Supports 3Mb/s to 3Gb/s digital video signals
- Output expansion in increments of 18, from 18 through to 576
- Auto configurable:
 - Reclocking
 - Non-reclocking
 - ASI mode
- Front access to all output modules
- All modules are hot-swappable
- Fan cooled

Figure 6-3 below shows the view of Output card edge and Table 6-3 gives the description of each component.



Figure 6-3 : EQX-OP18-3G (with Air Dam Fitted)



Figure 6-4 : EQX-G-OP18-3G (with Air Dam Fitted)

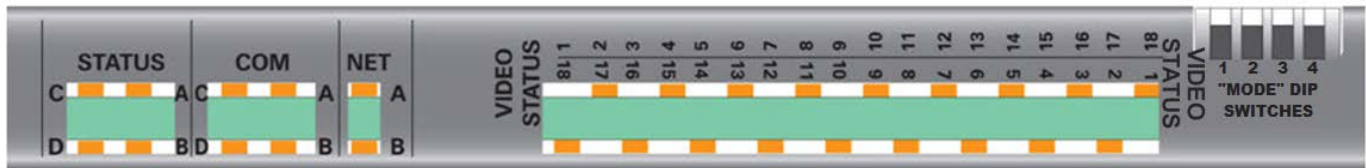

Figure 6-5 : EQX-OP18-3G – Air Dam Detail



Figure 6-6 : EQX-G-OP18-3G – Air Dam Detail

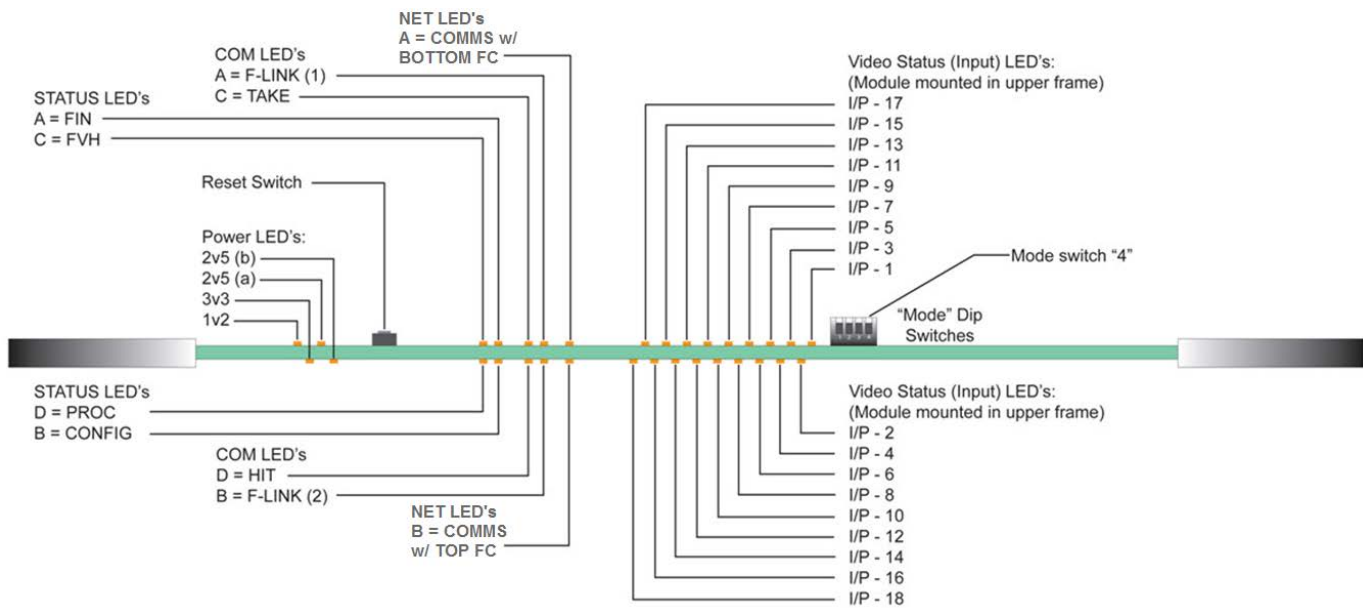

Figure 6-7 : EQX-OP18-3G/EQX-G-OP18-3G – Mounted in Upper Frame (with Air Dam Removed)

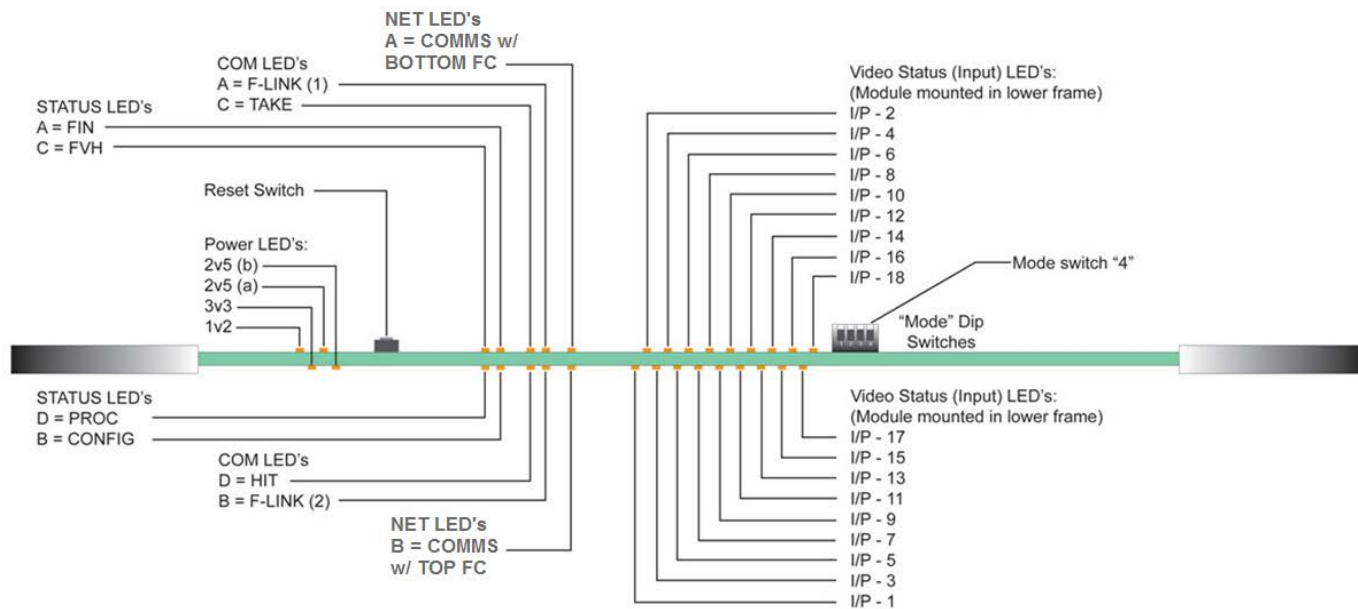

Figure 6-8 : EQX-OP18-3G/EQX-G-OP18-3G – Mounted in Lower Frame (with Air Dam Removed)

LED POWER LED's	Colour	Function
1v2	Yellow	1v2 Power rail present
3v3	Yellow	3v3 Power rail present
2v5 (a)	Yellow	2v5 (a) Power rail present
2v5 (b)	Yellow	2v5 (b) Power rail present

LED STATUS LED's	Colour	Function
FVH	Green	Single flash toggling with the Proc LED indicates 50Hz while double flash indicates 59.94Hz.
	Red	Steady Red indicates loss of input reference or error.
RP	Red	Indicates that the I/O RP is not present.
CONFIG		Illuminates when all the FPGAs have been configured correctly.
PROC	Green	Flashes at approximately 1 second intervals when the processor is OK and the ref is present. Flashes quickly during FPGA configuration.

LED COM LED's	Colour	Function
Take	Green	Flashes when the module has performed a "Take".
F-Link (1) "TX"	Green	F-Link TX - Flashes when the F-Link module has transmitted data.
F-Link (2) "RX"	Yellow	F-Link RX - Flashes when any F-Link comms are detected.
	Red	Steady Red indicates error.
F-Link Address Hit	Green	Flashes when there was a valid hit on the module.

LED NET LED's	Colour	Function
A	Orange	Bottom FC Ethernet COMMS
B	Green	Top FC Ethernet COMMS

LED VIDEO LED's	Colour	Function
O/P - 1	Green	Indicates that a signal is present on O /P 1
O /P - 2	Green	Indicates that a signal is present on O /P 2
O /P - 3	Green	Indicates that a signal is present on O /P 3
O /P - 4	Green	Indicates that a signal is present on O /P 4
O /P - 5	Green	Indicates that a signal is present on O /P 5
O /P - 6	Green	Indicates that a signal is present on O /P 6
O /P - 7	Green	Indicates that a signal is present on O /P 7
O /P - 8	Green	Indicates that a signal is present on O /P 8
O /P - 9	Green	Indicates that a signal is present on O /P 9
O /P - 10	Green	Indicates that a signal is present on O /P 10
O /P - 11	Green	Indicates that a signal is present on O /P 11
O /P - 12	Green	Indicates that a signal is present on O /P 12
O /P - 13	Green	Indicates that a signal is present on O /P 13
O /P - 14	Green	Indicates that a signal is present on O /P 14
O /P - 15	Green	Indicates that a signal is present on O /P 15
O /P - 16	Green	Indicates that a signal is present on O /P 16
O /P - 17	Green	Indicates that a signal is present on O /P 17
O /P - 18	Green	Indicates that a signal is present on O /P 18

MODE Dip Switch		
Switch 1	F-Link Baud Rate	(Factory setting = UP)
Switch 2	DOWN = All channels to bypass reclock circuit	(Factory setting = UP)
Switch 3	Not used	(Factory setting = UP)
Switch 4	UP = FVH 50 DOWN = FVH 59.94	(Factory setting = N/A)

Table 6-3 : Component Description Of EQX-OP18-3G/ EQX-G-OP18-3G Modules



Note: Air Dams may vary in shape for different IO modules, but the details on them are the same.



Note: The order of the VIDEO STATUS LEDs is reversed when the Output module is fitted into the lower section of the frame. The LEDs confirm that the signal has been reclocked correctly. If the reclockers are bypassed (non-reclocking mode) then the corresponding LED will switch off.

6.3.3 EQX-OP16AE-3G-2TDM (AUDIO VIDEO Output Processor)

The EQX AVOP module comprises of 16 reclocked output channels fed from the crosspoint modules. On each output the reclocking facility can be switched On/Off or switched into ASI bypass mode as required.

Like the AVIP module, each of the AVOP modules support sixteen (16) digital video outputs plus two (2)TDM input streams using industry standard BNC connectors mounted on the passive I/O RP.

The EQX router can be loaded with a maximum of 32 AVOP modules, providing square and non-square configurations from 16 outputs plus 2 TDM inputs through to 512 physical outputs in increments of 18.

AVOP module manages digital video and embedded audio signals from 3Mb/s through to 3Gb/s. Also it de-multiplexes audio from 1 or 2 TDM input streams and re-embeds them to video Standards that are supported are listed below:

- SDI (625 and/or 525)
- 3G and HDSDI (720p, 1080i, 1080p etc)
- DVB-ASI
- SMPTE310

All of the AVOP modules are accessed from the front of the frame and can be replaced while the EQX router is still operational should one of the modules fail. The output modules are air cooled by the fans mounted in the upper and lower half of the frame.

6.3.3.1 EQX-OP16AE-3G-2TDM - Key Features

- Passes 3G and HD SDI digital video plus Embedded Audio
- Passes SDI digital video plus Embedded Audio
- Ability to re-embed audio to the video from streams over TDM
- Supports 3Mb/s to 3Gb/s digital video signals
- Output expansion in increments of 16 plus 2, from 18 through to 512
- Auto configurable:
 - Reclocking
 - Non-reclocking
 - ASI mode
- Provides SRC (Sample Rate Conversion) option via VLPRO
- Front access to all AVOP modules
- All modules are hot-swappable
- Fan cooled

Figure 6-9 below shows the card edge view of AVOP Table 6-4 gives the description of each component.

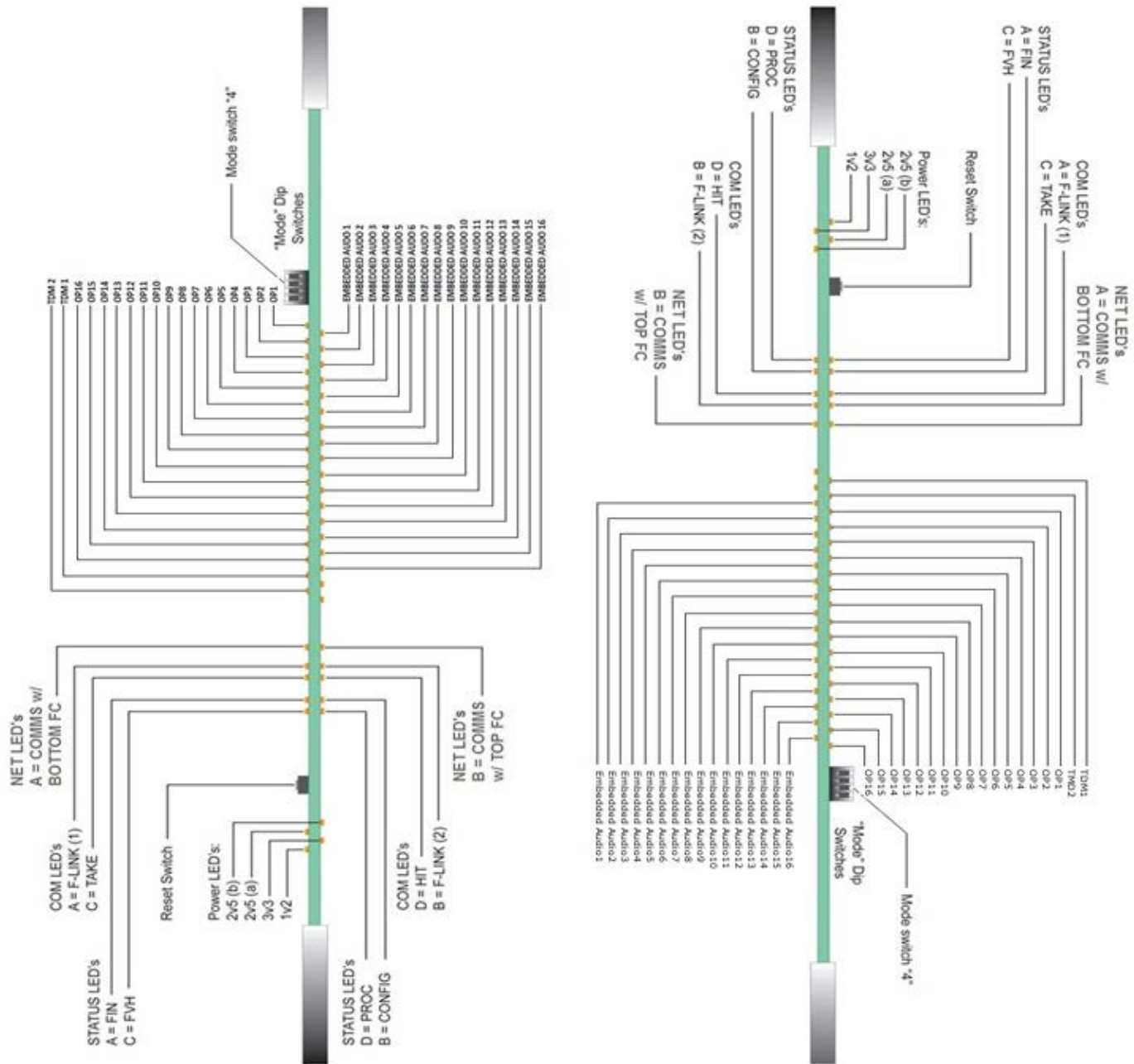

Figure 6-9 : AVOP on the Left mounted in upper frame/ AVOP on the right mounted in the lower frame

The figure below shows the rear view of an EQX frame with two AVIPs and two AVOPs on the top half of the frame and two AVIPs and two AVOPs on the bottom half of the frame. When AVIPs and AVOPs are in the top half of the frame, the last two BNCs are reserved for TDM input and outputs. However, when these cards are in the bottom half, the first two BNCs are reserved for TDM inputs and outputs and the SDI inputs and outputs start from third BNC.

19	1		19	1
Input 19	Input 1		Output 19	Output 1
Input 20	Input 2		Output 20	Output 2
Input 21	Input 3		Output 21	Output 3
Input 22	Input 4		Output 22	Output 4
Input 23	Input 5		Output 23	Output 5
Input 24	Input 6		Output 24	Output 6
Input 25	Input 7		Output 25	Output 7
Input 26	Input 8		Output 26	Output 8
Input 27	Input 9		Output 27	Output 9
Input 28	Input 10		Output 28	Output 10
Input 29	Input 11		Output 29	Output 11
Input 30	Input 12		Output 30	Output 12
Input 31	Input 13		Output 31	Output 13
Input 32	Input 14		Output 32	Output 14
Input 33	Input 15		Output 33	Output 15
Input 34	Input 16		Output 34	Output 16
TDM1 Out	TDM1 Out		TDM1 In	TDM1 In
TDM2 Out	TDM2 Out		TDM2 In	TDM2 In
36	18		36	18
TOP XPT				
MID XPT				
BOT XPT				
307	289		307	289
TDM1 Out	TDM1 Out		TDM1 In	TDM1 In
TDM2 Out	TDM2 Out		TDM2 In	TDM2 In
Input 309	Input 291		Output 309	Output 291
Input 310	Input 292		Output 310	Output 292
Input 311	Input 293		Output 311	Output 293
Input 312	Input 294		Output 312	Output 294
Input 313	Input 295		Output 313	Output 295
Input 314	Input 296		Output 314	Output 296
Input 315	Input 297		Output 315	Output 297
Input 316	Input 298		Output 316	Output 298
Input 317	Input 299		Output 317	Output 299
Input 318	Input 300		Output 318	Output 300
Input 319	Input 301		Output 319	Output 301
Input 320	Input 302		Output 320	Output 302
Input 321	Input 303		Output 321	Output 303
Input 322	Input 304		Output 322	Output 304
Input 323	Input 305		Output 323	Output 305
Input 324	Input 306		Output 324	Output 306
324	306		324	306

Figure 6-10 : Physical input and output of AVIP/AVOP at the back of EQX frame

LED POWER LED's	Colour	Function
1v2	Yellow	1v2 Power rail present
3v3	Yellow	3v3 Power rail present
2v5 (a)	Yellow	2v5 (a) Power rail present
2v5 (b)	Yellow	2v5 (b) Power rail present

LED STATUS LED's	Colour	Function
FVH	Green	Single flash toggling with the Proc LED indicates 50Hz while double flash indicates 59.94Hz.
	Red	Steady Red indicates loss of input reference or error.
RP	Red	Indicates that the I/O RP is not present.
CONFIG		Illuminates when all the FPGAs have been configured correctly.
PROC	Green	Flashes at approximately 1 second intervals when the processor is OK and the ref is present. Flashes quickly during FPGA configuration.
LED COM LED's	Colour	Function
Take	Green	Flashes when the module has performed a "Take".
F-Link (1) "TX"	Green	F-Link TX - Flashes when the F-Link module has transmitted data.

F-Link (2) "RX"	Yellow	F-Link RX - Flashes when any F-Link comms are detected.
	Red	Steady Red indicates error.
F-Link Address Hit	Green	Flashes when there was a valid hit on the module.

LED NET LED's	Colour	Function
A	Orange	Bottom FC Ethernet COMMS
B	Green	Top FC Ethernet COMMS

LED VIDEO LED's	Colour	Function
O/P - 1	Green	Indicates that a signal is present on O /P 1
O /P - 2	Green	Indicates that a signal is present on O /P 2
O /P - 3	Green	Indicates that a signal is present on O /P 3
O /P - 4	Green	Indicates that a signal is present on O /P 4
O /P - 5	Green	Indicates that a signal is present on O /P 5
O /P - 6	Green	Indicates that a signal is present on O /P 6
O /P - 7	Green	Indicates that a signal is present on O /P 7
O /P - 8	Green	Indicates that a signal is present on O /P 8
O /P - 9	Green	Indicates that a signal is present on O /P 9
O /P - 10	Green	Indicates that a signal is present on O /P 10
O /P - 11	Green	Indicates that a signal is present on O /P 11
O /P - 12	Green	Indicates that a signal is present on O /P 12
O /P - 13	Green	Indicates that a signal is present on O /P 13
O /P - 14	Green	Indicates that a signal is present on O /P 14
O /P - 15	Green	Indicates that a signal is present on O /P 15
O /P - 16	Green	Indicates that a signal is present on O /P 16
TDM1	Green	Indicates that a TDM signal present
TDM2	Green	Indicate that a TDM signal present

MODE Dip Switch		
Switch 1	F-Link Baud Rate	(Factory setting = UP)
Switch 2	DOWN = All channels to bypass reclock circuit	(Factory setting = UP)
Switch 3	Not used	(Factory setting = UP)
Switch 4	UP = FVH 50 DOWN = FVH 59.94	(Factory setting = N/A)

Table 6-4 : Component Description Of AVIP/AVOP Modules



Note: The order of the VIDEO STATUS LEDs is reversed when the AVOP module is fitted into the lower section of the frame. The LEDs confirm that the signal has been reclocked correctly. If the reclockers are bypassed (non-reclocking mode) then the corresponding LED will switch off.

6.3.4 EQX-OP18-3G-F1 Modules

The EQX Fiber output module comprises of 18 reclocked optical channels fed from the crosspoint modules through SFPs. On each fiber output the reclocking facility can be switched On/Off or switched into ASI bypass mode as required.

Each of the fiber output modules support eighteen (18) optical outputs via 9 dual channel SFPs mounted on the active output RP.

The EQX router can be loaded with a maximum of 32 fiber output modules, providing square and non-square configurations from 18 optical outputs through to 576 optical outputs in increments of 18.

Fiber output modules convert electrical signals to optical signals from 3Mb/s through to 3Gb/s. Standards that are supported are listed below:

- SDI (625 and/or 525)
- 3G and HDSDI (720p, 1080i, 1080p etc)
- DVB-ASI
- SMPTE310

All of the fiber modules are accessed from the front of the frame and can be replaced while the EQX router is still operational should one of the modules fail. The fiber modules are air cooled by the fans mounted in the upper and lower half of the frame.

6.3.4.1 EQX-OP18-3G-F1 - Key Features

- Converts electrical signal to optical
- Passes 3G and HD SDI digital video plus Embedded Audio
- Passes SDI digital video plus Embedded Audio
- Supports 3Mb/s to 3Gb/s digital video signals
- Output expansion in increments of 18, from 18 through to 576
- Auto configurable:
 - Reclocking
 - Non-reclocking
 - ASI mode
- Front access to all Fiber output modules
- All modules are hot-swappable
- Fan cooled

6.3.5 EQX-OP16AE-3G-2TDM-F1 (FIBER AUDIO VIDEO output processor)

The EQX Fiber AVOP module comprises of 16 reclocked optical channels fed from the crosspoint modules through SFPs. On each output the reclocking facility can be switched On/Off or switched into ASI bypass mode as required.

Like the Fiber AVIP module, each of the fiber AVOP modules support sixteen (16) optical outputs through 8 dual channels SFPs plus two (2)TDM steam inputs using industry standard BNC connectors mounted on the active output RP.

The EQX router can be loaded with a maximum of 32 Fiber AVOP modules, providing square and non-square configurations from 16 optical outputs plus 2 TDM inputs through to 512 physical outputs in increments of 18.

Fiber AVOP module converts electrical signals to optical signals from 3Mb/s through to 3Gb/s. Also, it demultiplexes audio from 1 or 2 TDM input streams and re-embeds them to video

Standards that are supported are listed below:

- SDI (625 and/or 525)
- 3G and HDSDI (720p, 1080i, 1080p etc)
- DVB-ASI

- SMPTE310

All of the Fiber AVOP modules are accessed from the front of the frame and can be replaced while the EQX router is still operational should one of the modules fail. The output modules are air cooled by the fans mounted in the upper and lower half of the frame.

6.3.5.1 EQX-OP16AE-3G-2TDM-F1 - Key Features

- Converts electrical signal to optical
- Passes 3G and HD SDI digital video plus Embedded Audio
- Passes SDI digital video plus Embedded Audio
- Ability to re-embed audio to the video from streams over TDM
- Supports 3Mb/s to 3Gb/s digital video signals
- Output expansion in increments of 16 plus 2, from 18 through to 512
- Works same as ordinary Fiber module
- Auto configurable
 - Reclocking
 - Non-reclocking
 - ASI mode
- Provides SRC (Sample Rate Conversion) option via VLPRO
- Front access to all modules
- All modules are hot-swappable
- Fan cooled



Note: The card edge view for Fiber output is the same as the normal output module and the card edge view for Fiber AVOP is the same as the normal AVOP module.

6.3.6 Fiber Optic Outputs

The EQX router is able to launch Fiber Optic output/input when ordered with the optional Fiber Optic output modules. These modules utilize an “SFP” module (Small Form-Factor Pluggable). Each SFP for the Fiber Optic output module is a dual channel TRANSMITTER. This means Optical signals can be wired as coaxial signals, where all inputs are wired to one type of module and all outputs are wired to another. The Output SFP (or transmitter SFP) is called SFP1T-13-2 and can accept signals from 3Mb/s to 3Gb/s depending on the type of input module that they are mated with.



Figure 6-11 : SFP1T-13-2 Module

- The SFP1T-13-2 supports SMPTE 259M, SMPTE 344M, SMPTE 292M and SMPTE 424M and other data rates
- The SFP1T-13-2 is hot swappable, and is inserted and removed without the need for specialized tools
- RoHS compliant
- Operating temperature range: 0°C to 70°C
- 56.5mm x 13.4mm x 8.6mm standard SFP Package
- Each signal is on an individual connector of type LC
- Monitoring capability over serial or VLPRO



Note: For dual channel single wavelength SFPs the orientation of the modules is not important, the SRC or DST number always remain the same; however, for dual channel dual wavelength the orientation is important. The wavelength will follow the channel on the SFP, but the SRC or DST numbers on the router still remain unchanged. Shown in Figure 6-11.

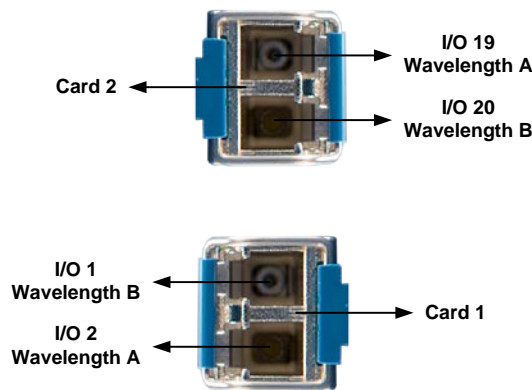

Figure 6-12 : Orientation of the SFPs for two different slots

6.3.7 EQX-OP18-3G (HD)-EX/EQX-OP36-3G (HD)-XIO

The EQX-XIO output module comprises of 36 reclocked output channels fed from the crosspoint modules. On each output the reclocking facility can be switched On/Off or switched into ASI bypass mode as required.

Each of the output modules support Thirty-six (36) digital video outputs using standard DIN 1.0/2.3 and X-Link connectors mounted on the passive I/O RP.



Note: In a XIO module, the outputs are not in sequence. .E.g. if the XIO module is fitted in the first output slot, the upper 18 outputs start from 1 to 18 and the lower 18 outputs start from 577 to 594.

In the serial menu under 'Monitoring and Configuration', the crosspoint profile can be changed to one of the following modes:

ID	Option	Description
1	OP18	The first 18 will be enabled only
2	OP36	All 36 outputs will be enabled with no redundancy capability

3	OP36-DA	The second 18 outputs will be the mirror of the first 18
4	OP36 XIO Dual frame	Used for multi-frame systems
5	OP36 Redundancy Top	Not used
6	OP36 Redundancy Bot	All 36 outputs are enabled with redundancy capability

Table 6-5 : Crosspoint Profile Modes

The EQX router can be loaded with a maximum of 32 output modules, providing square and non-square configurations from 18 outputs through to 576 outputs and 577 outputs through to 1152 outputs in increments of 18 and 18 respectively.

The output module manages digital video and embedded audio signals from 3Mb/s through to 3Gb/s. The following are supported:

- SDI (625 and/or 525)
- HDSDI (720p, 1080i, 1080p etc)
- DVB-ASI
- SMPTE310

All of the output modules are accessed from the front of the frame and can be replaced while the EQX router is still operational should one of the modules fail. The output modules are air cooled by the fans mounted in the upper and lower half of the frame.

6.3.7.1 EQX-OP18-3G (HD)-EX/EQX-OP36-3G (HD)-XIO - Key Features

- Passes 3G and HD SDI digital video plus Embedded Audio
- Passes SDI digital video plus Embedded Audio
- Supports 3Mb/s to 3Gb/s digital video signals
- Output expansion in increments of 18 and 18, from 18 through to 576 and 577 through to 1152
- Auto configurable:
 - Reclocking
 - Non-reclocking
 - ASI mode
- Front access to all modules
- All modules are hot-swappable
- Fan cooled

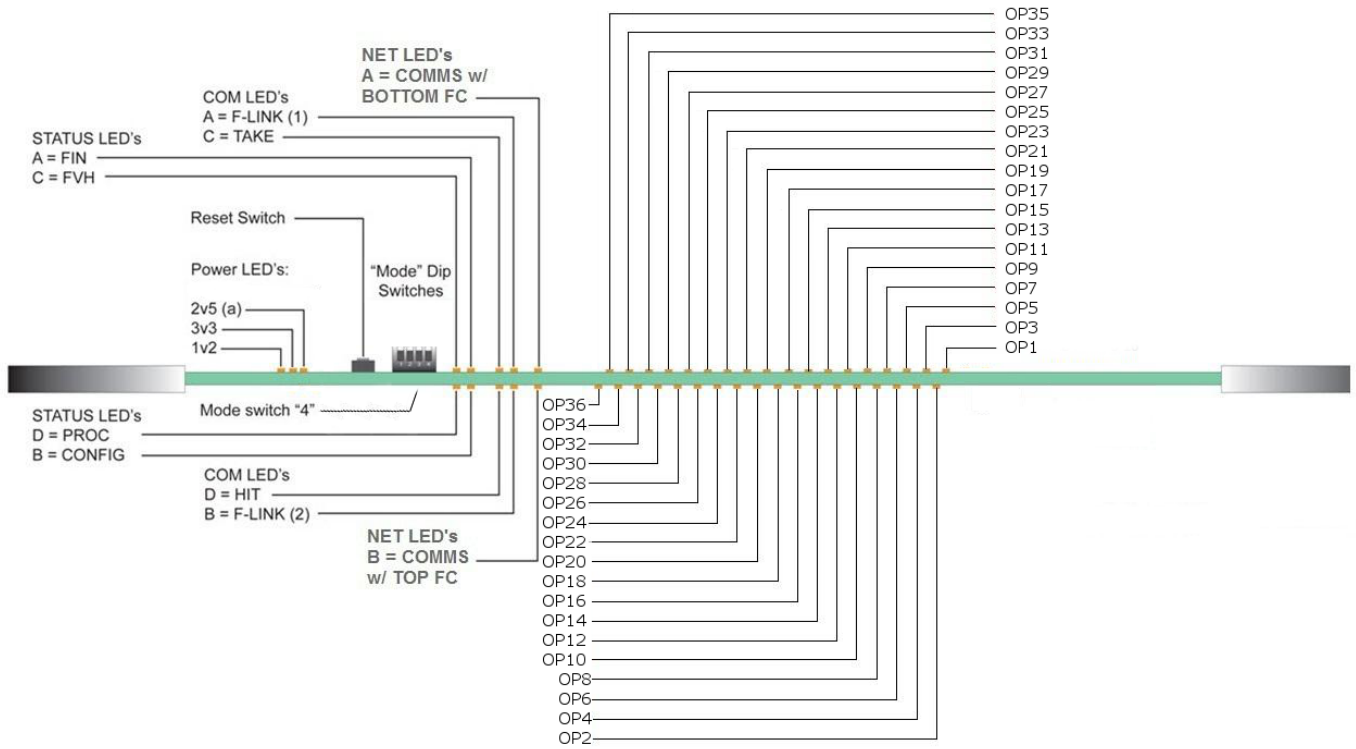

Figure 6-13 : EQX-OP18-3G-EX/EQX-OP36-3G-XIO– Mounted in Upper Frame (with Air Dam Removed)

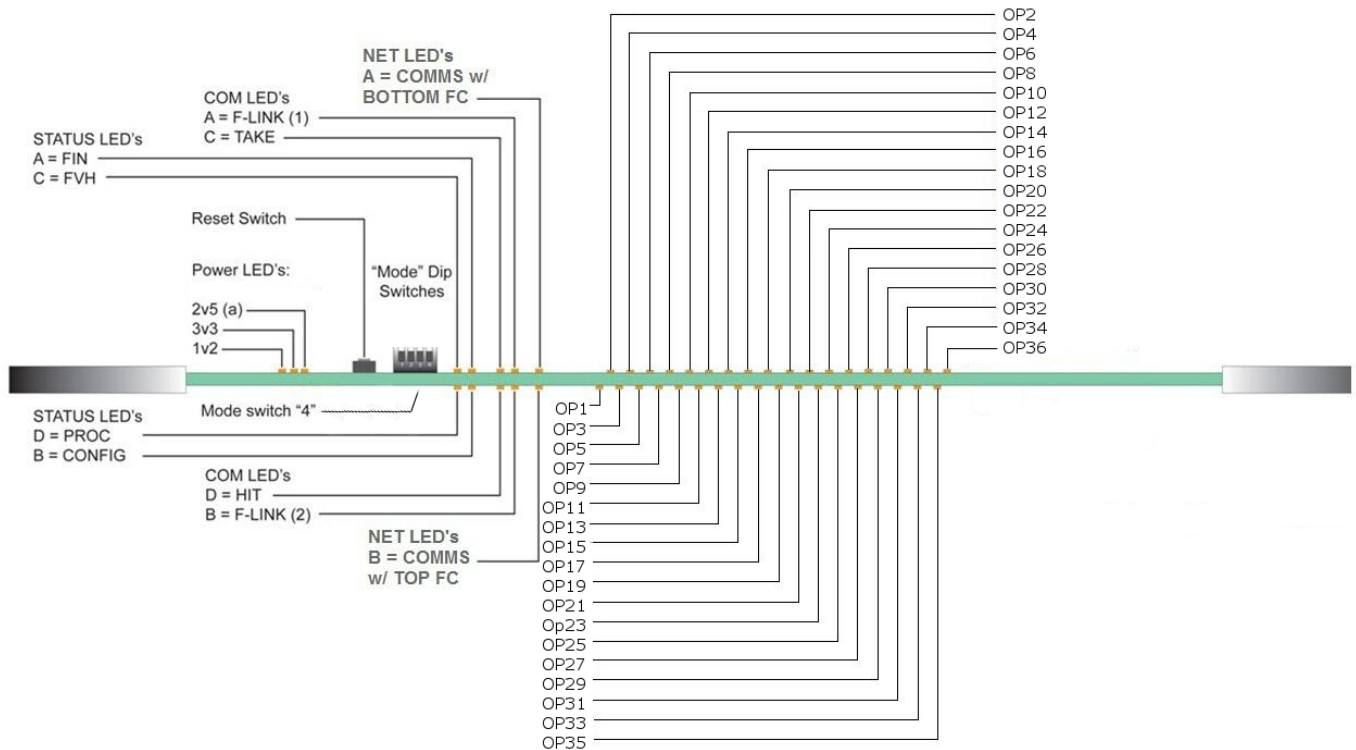

Figure 6-14 : EQX-OP18-3G-EX/EQX-OP36-3G-XIO– Mounted in Lower Frame (with Air Dam Removed)

LED POWER LED's	Colour	Function
1v2	Yellow	1v2 Power rail present
3v3	Yellow	3v3 Power rail present
2v5 (a)	Yellow	2v5 (a) Power rail present

LED STATUS LED's	Colour	Function
FVH	Green	Single flash toggling with the Proc LED indicates 50Hz while double flash indicates 59.94Hz.
	Red	Steady Red indicates loss of input reference or error.
RP	Red	Indicates that the I/O RP is not present.
CONFIG		Illuminates when all the FPGAs have been configured correctly.
PROC	Green	Flashes at approximately 1 second intervals when the processor is OK and the ref is present. Flashes quickly during FPGA configuration.

LED COM LED's	Colour	Function
Take	Green	Flashes when the module has performed a "Take".
F-Link (1) "TX"	Green	F-Link TX - Flashes when the F-Link module has transmitted data.
F-Link (2) "RX"	Yellow	F-Link RX - Flashes when any F-Link comms are detected.
	Red	Steady Red indicates error.
F-Link Address Hit	Green	Flashes when there was a valid hit on the module.

LED NET LED's	Colour	Function
A	Orange	Bottom FC Ethernet COMMS
B	Green	Top FC Ethernet COMMS

LED VIDEO LED's	Colour	Function
O/P - 1	Green	Indicates that a signal is present on O /P 1
O /P - 2	Green	Indicates that a signal is present on O /P 2
O /P - 3	Green	Indicates that a signal is present on O /P 3
O /P - 4	Green	Indicates that a signal is present on O /P 4
O /P - 5	Green	Indicates that a signal is present on O /P 5
O /P - 6	Green	Indicates that a signal is present on O /P 6
O /P - 7	Green	Indicates that a signal is present on O /P 7
O /P - 8	Green	Indicates that a signal is present on O /P 8
O /P - 9	Green	Indicates that a signal is present on O /P 9
O /P - 10	Green	Indicates that a signal is present on O /P 10
O /P - 11	Green	Indicates that a signal is present on O /P 11
O /P - 12	Green	Indicates that a signal is present on O /P 12
O /P - 13	Green	Indicates that a signal is present on O /P 13
O /P - 14	Green	Indicates that a signal is present on O /P 14
O /P - 15	Green	Indicates that a signal is present on O /P 15
O /P - 16	Green	Indicates that a signal is present on O /P 16
O /P - 17	Green	Indicates that a signal is present on O /P 17
O /P - 18	Green	Indicates that a signal is present on O /P 18
OP 19-36	Green	Indicate that signal is present on O /P 19-36

Table 6-6 : LED Description

6.4 EQX INPUT & OUTPUT (I/O) REAR PLATES

Mounted in the rear of the EQX frame are the Input and Output (I/O) Rear Plates. These modules are completely passive for normal I/O modules; they have no components other than the 18 BNC connectors, however; RPs are active for Fiber I/O modules and they have other components beside the SPF housings.

The EQX router is fitted with industry standard BNC connectors or dual channel SFP housings.

The I/O RPs provides the link through the EQX frame to the input and output modules. The layout of the I/O RPs follows the same layout as the input and output modules.

The Output RPs occupy the 8 locations on the far right and far left hand side of the frame in both the upper and lower section. The Input RPs occupies the 16 central locations of the frame in both the upper and lower section.

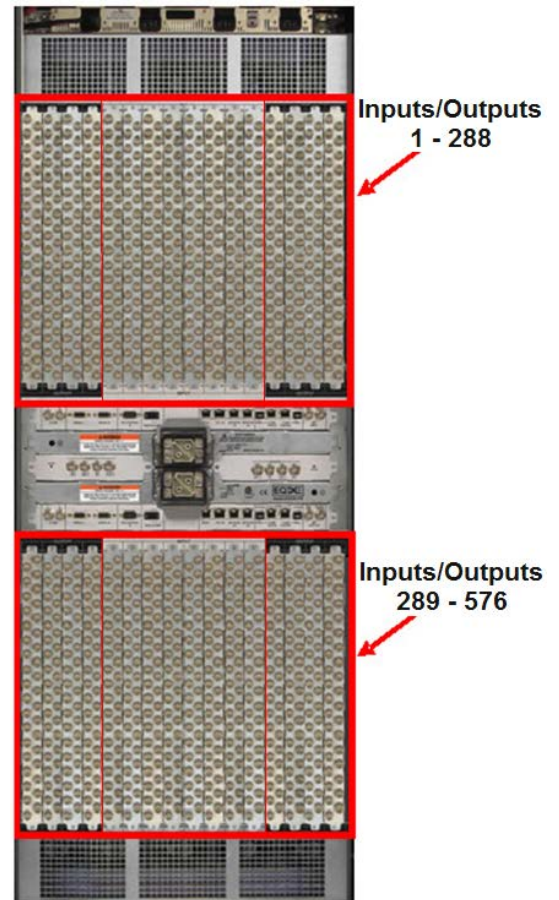
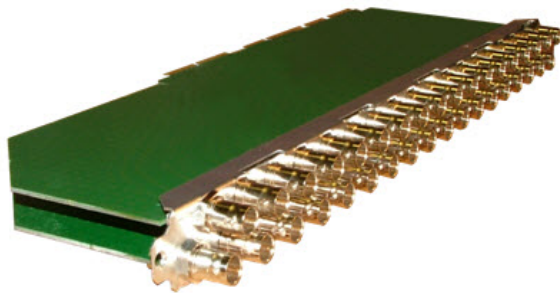

6.4.1 Coaxial I/O RP - Key Features

- Completely passive module
- Provides the link from the BNC connector to the input or output module
- Each RP carries 36 industry standard BNC video connectors
- Each RP occupies two slots and provides link for two inputs or outputs modules
- All I/O RPs can be hot-swapped
- Same RP for INPUT and OUTPUT modules

Each RP supports 2 (two) modules of 18 channels each.



Note: All three frames 26RU, 16RU and 10RU share the same rear plates.

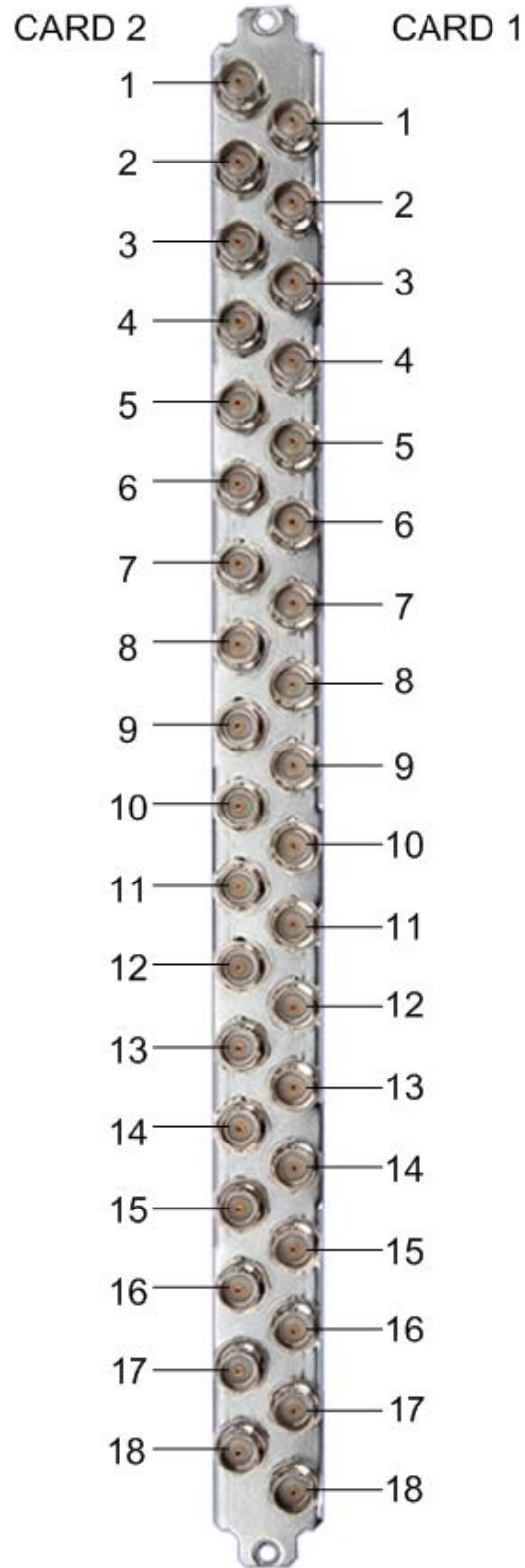
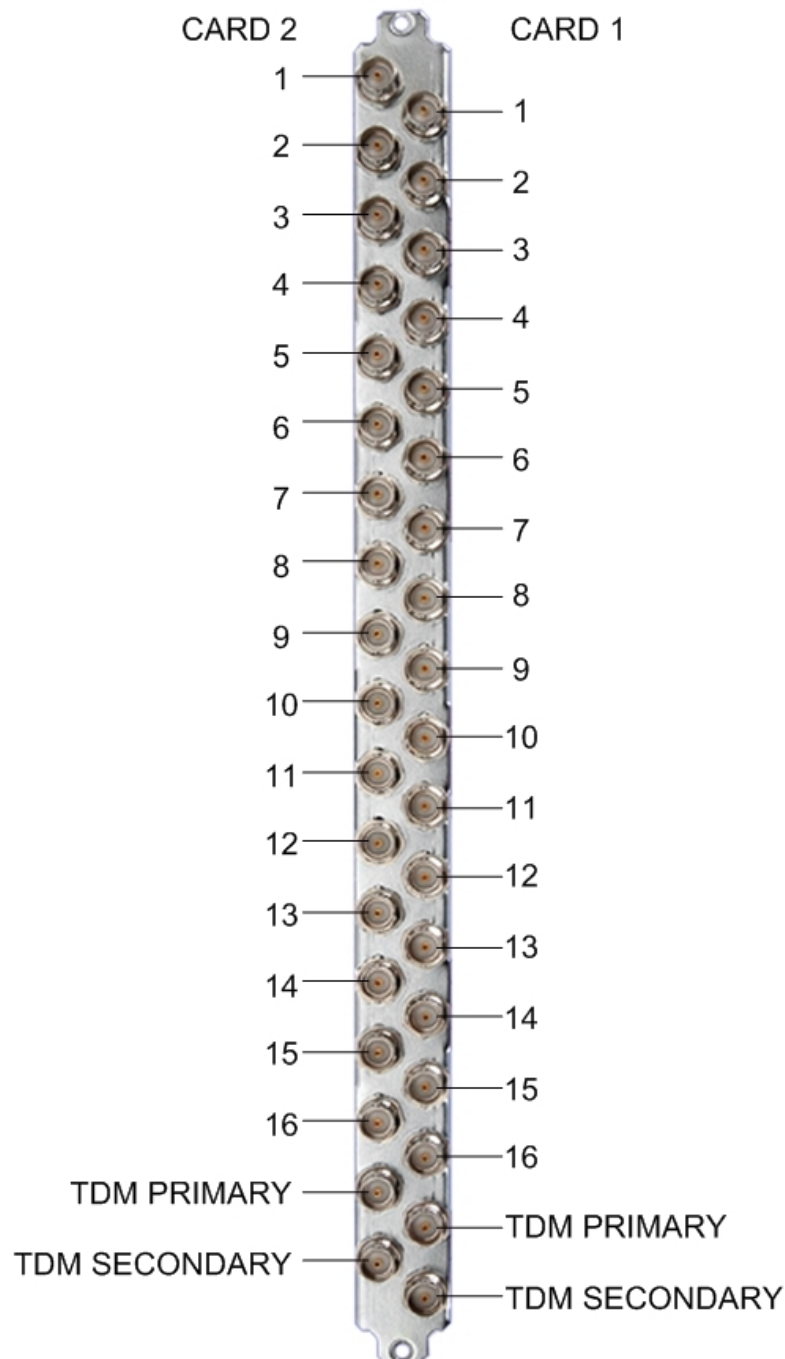

Figure 6-15 : EQX-IO18-RP

6.4.2 AVIP/AVOP RP - Key Features

- Completely passive module
- Provides the link from the BNC connector to the input or output module
- Each RP carries 36 industry standard BNC video connectors
- Each RP occupies two slots and provides link for two AVIP or AVOP modules
- All I/O RPs can be hot-swapped
- Same RP for AVIP, AVOP and normal I/O modules

Each RP supports 2 (two) modules of 16 channels each and 2 TDM signals.



**Figure 6-16 : EQX-IO18-RP
(AVIP/AVOP RP in Top Slot)**

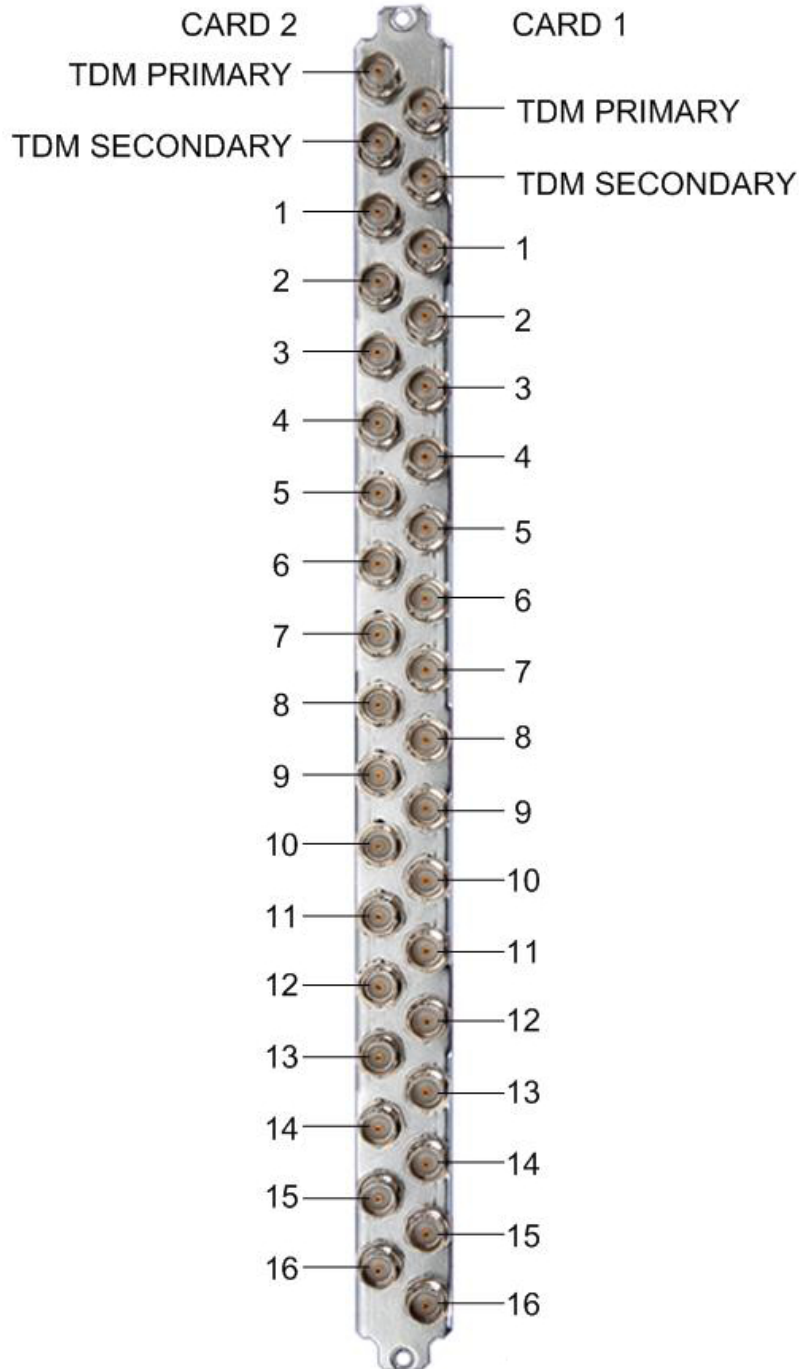

**Figure 6-17 : EQX-IO18-RP
(AVIP/AVOP RP in Bottom Slot)**

6.4.3 Fiber Optic I/O RP - Key Features

- Completely active module, Active SFPs are hot swappable
- Provides the link from the SFP housing connector to the input or output module
- Each RP occupies two slots and provides link for two inputs or outputs modules
- Each RP carries 18 standard SFP cages
- I/O RPs cannot be hot-swapped
- Different RP for fiber input and fiber output (Different hardware)

As each RP supports 2 (two) modules of 18 channels each, this rear plate has a total of 36 signals on it. Each SFP module is dual channel so there are 18 SFPs (18x2=36). Each module uses 9 SFPs (9x2=18 signals per typical input/output module).

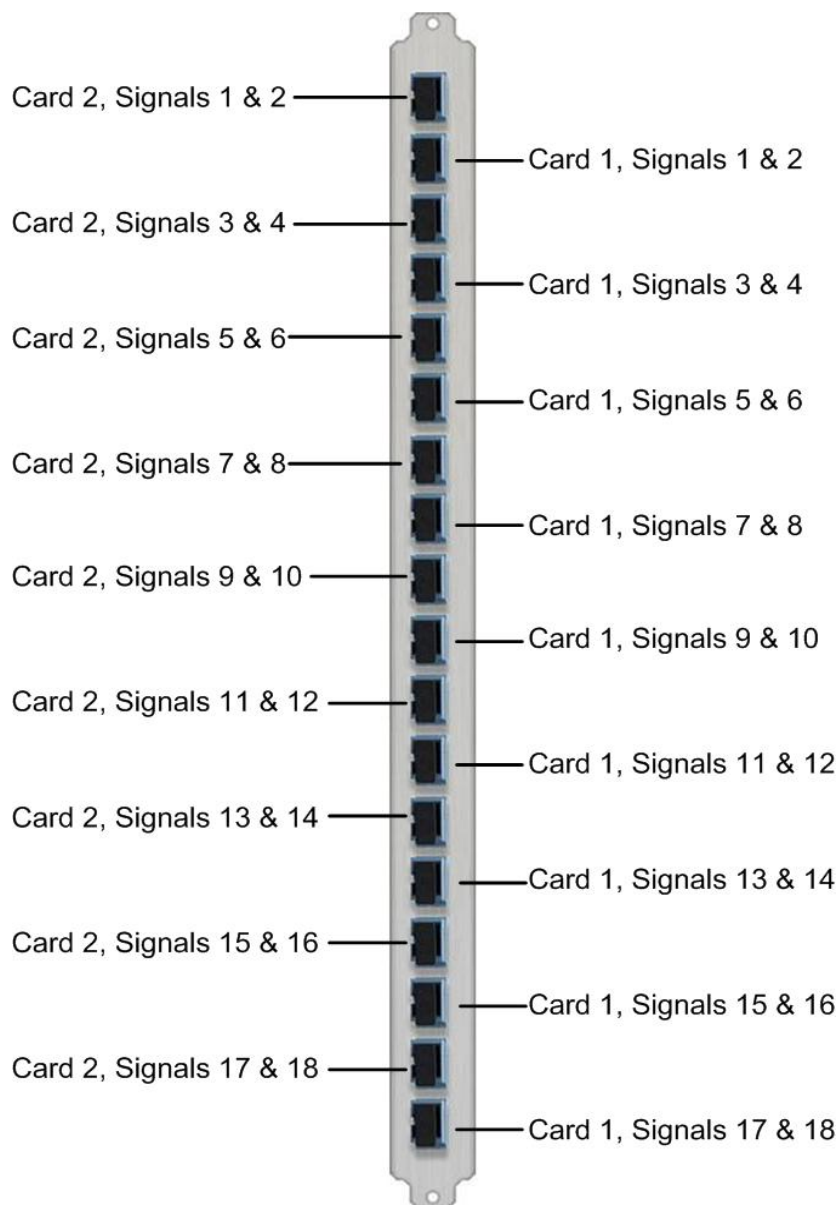

Figure 6-18 : EQX-IO18F-RP

6.4.4 Fiber Optic AVIP/AVOP RP - Key Features

- Completely active module, Active SFPs are hot swappable
- SFP monitoring
- Provides the link from the SFP housing connector to the input or output module
- Each RP occupies two slots and provides link for two fiber AVIP or fiber AVOP modules
- Each RP carries 16 standard SFP housing and four BNC for TDM connection
- I/O RPs cannot be hot-swapped
- Different RP for fiber AVIP and AVOP (Different hardware)

As each RP supports 2 (two) modules of 16 channels each, this rear plate has a total of 32 signals on it. Each SFP module is dual channel so there are 16 SFPs (16x2=32). Each module uses 8 SFPs (8x2=16 signals per typical input/output module) plus two TDM BNC connectors.

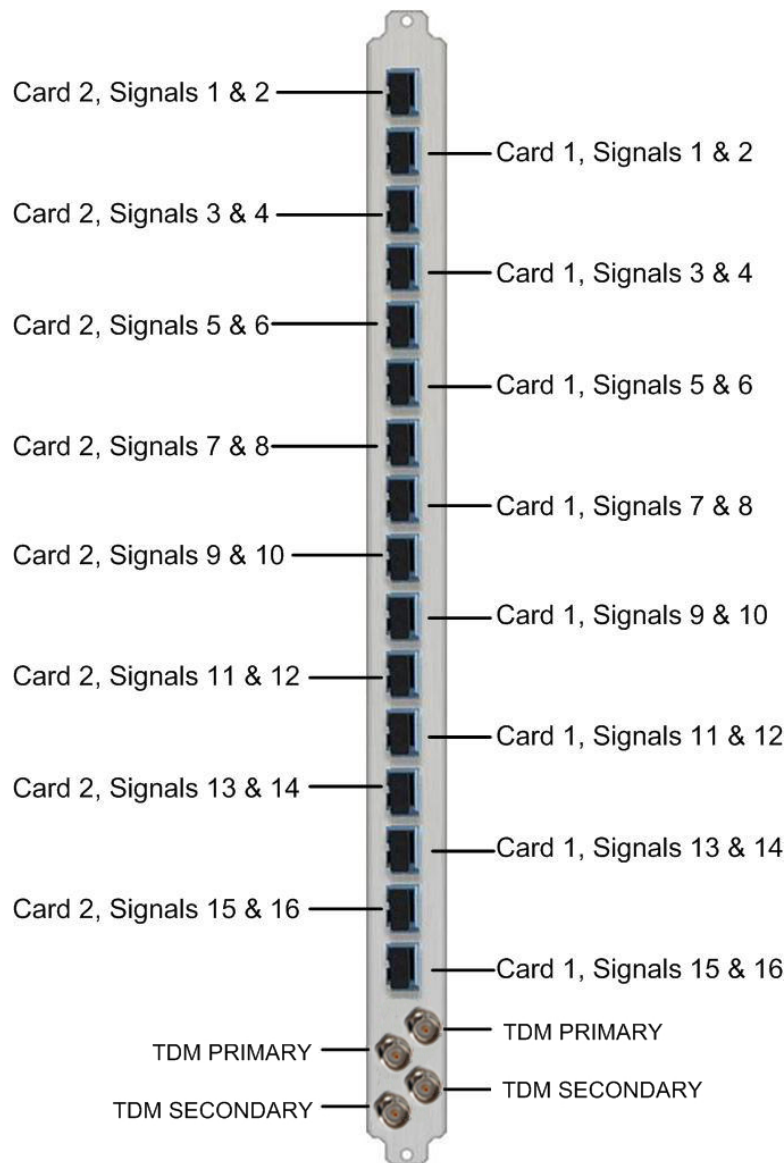

Figure 6-19 : EQX-IP16AD-3G-2TDM-F1-RP/EQX-OP16AE-3G-2TDM-F1-RP (Top Slot)

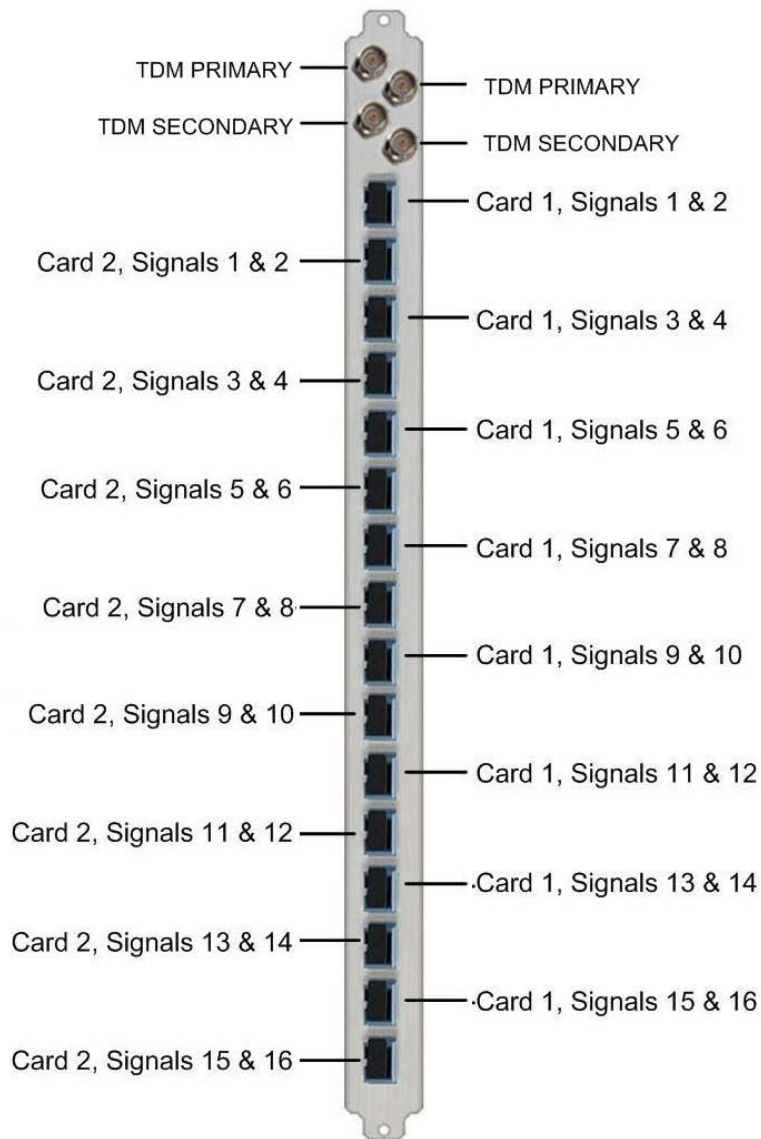

Figure 6-20 : EQX-IP16AD-3G-2TDM-F1-RP/EQX-OP16AE-3G-2TDM-F1-RP (Bottom slot)

6.4.5 Fiber optic EQX-IP18FSAD-3G-F RP Key Features

- Completely active module, Active SFPs are hot swappable
- Provides the link from the SFP housing connector to the input module
- Each RP occupies two slots and provides link for two inputs modules
- Each RP carries 18 standard SFP cages
- RP can be hot-swapped

As each RP supports 2 (two) FSAD modules of 18 channels each, this rear plate has a total of 36 signals on it. Each SFP module is dual channel so there are 18 SFPs (18x2=36). Each module uses 9 SFPs (9x2=18 signals per typical input module).

There are 8 din connectors, Two TDM outputs and Two TDM Inputs per FSAD.

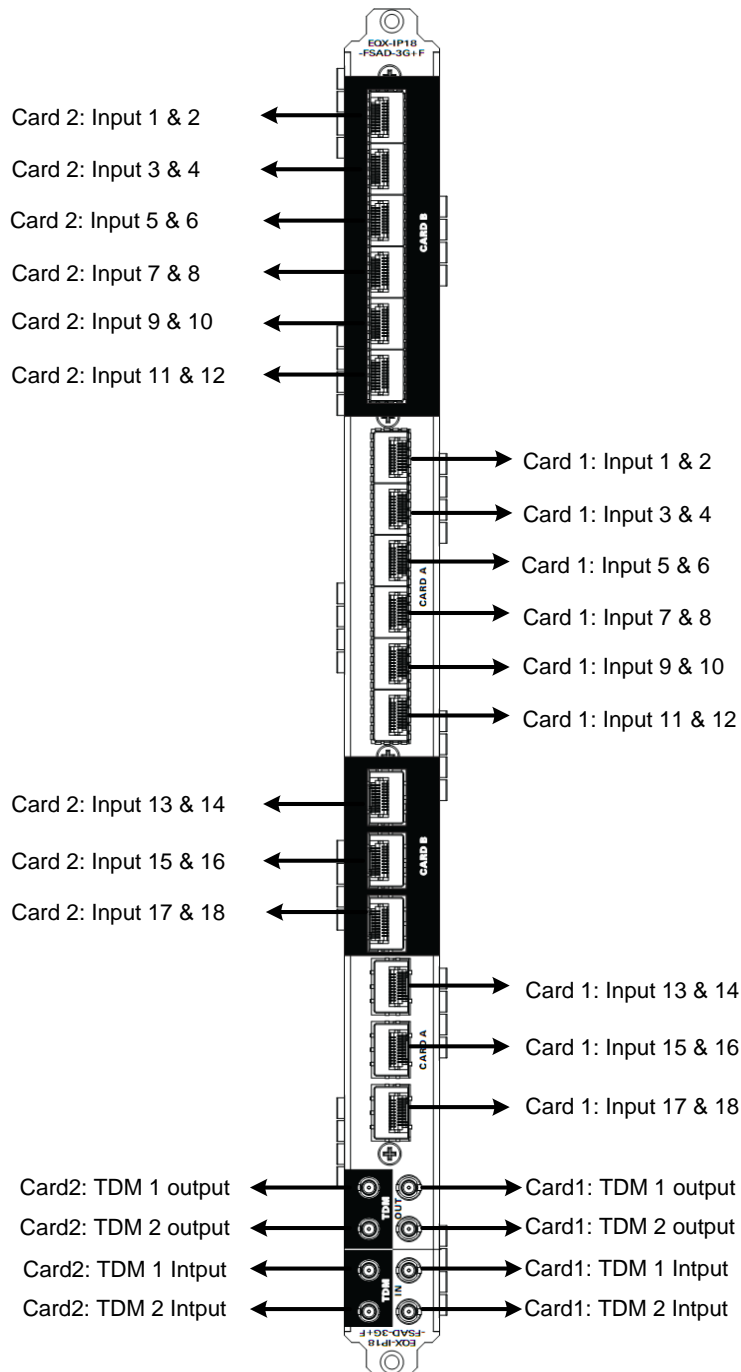

Figure 6-21 : EQX-IP18FSAD-3G-F RP (Top Slot)

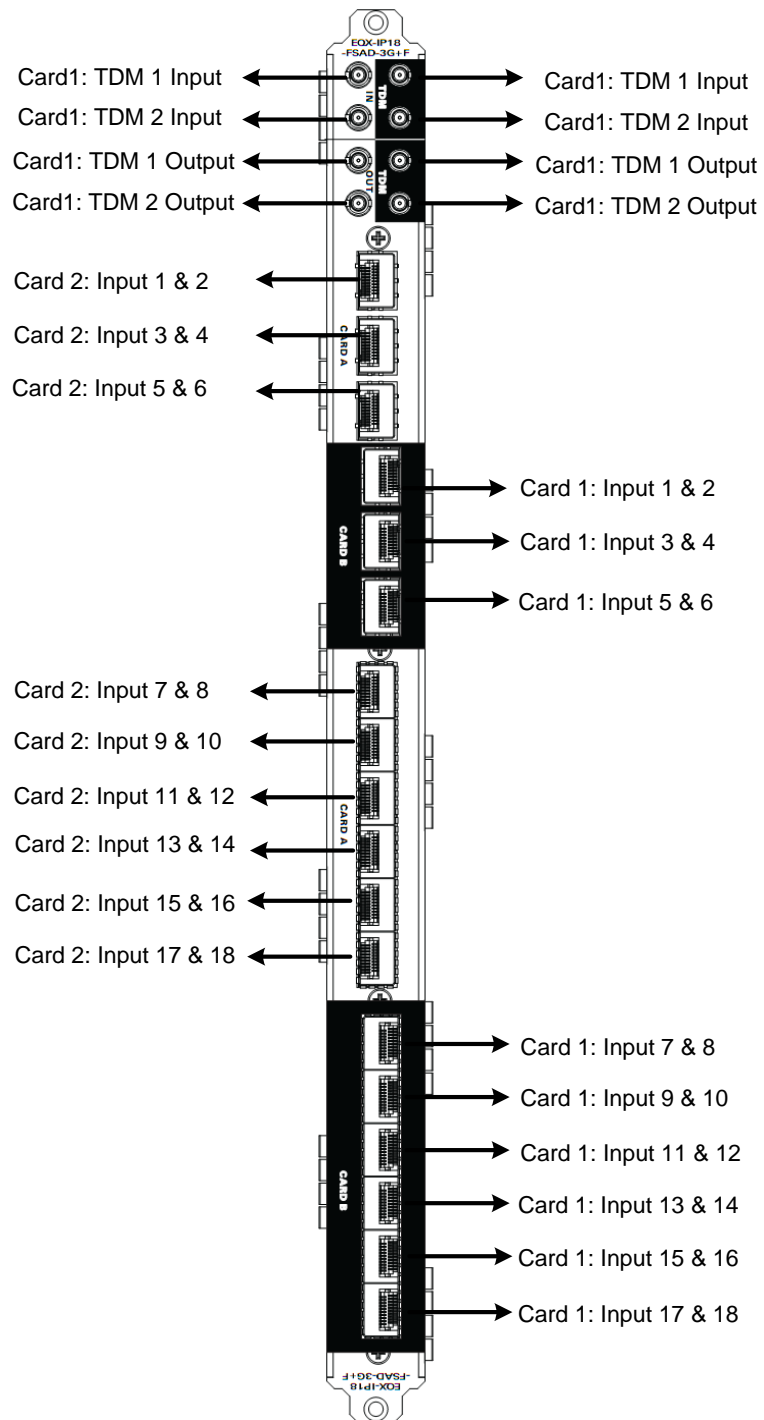

Figure 6-22 : EQX-IP18FSAD-3G-F (Bottom Slot)



Note: When the rear plate is installed on the top slots, the shaded SFP cages are reserved for the card on the left side (viewing from the back of the frame) and when the rear plate is installed in the bottom slots, the shaded SFP cages are reserved for the card located on the right side (viewing from the back of the frame).

6.4.6 XLINK Output RP - Key Features

- Completely passive module
- Each RP carries 2 XLINKS outputs and 8 Standard BNCs
- All I/O RPs can be hot-swapped

Each RP supports 2 (two) modules of 36 channels each.

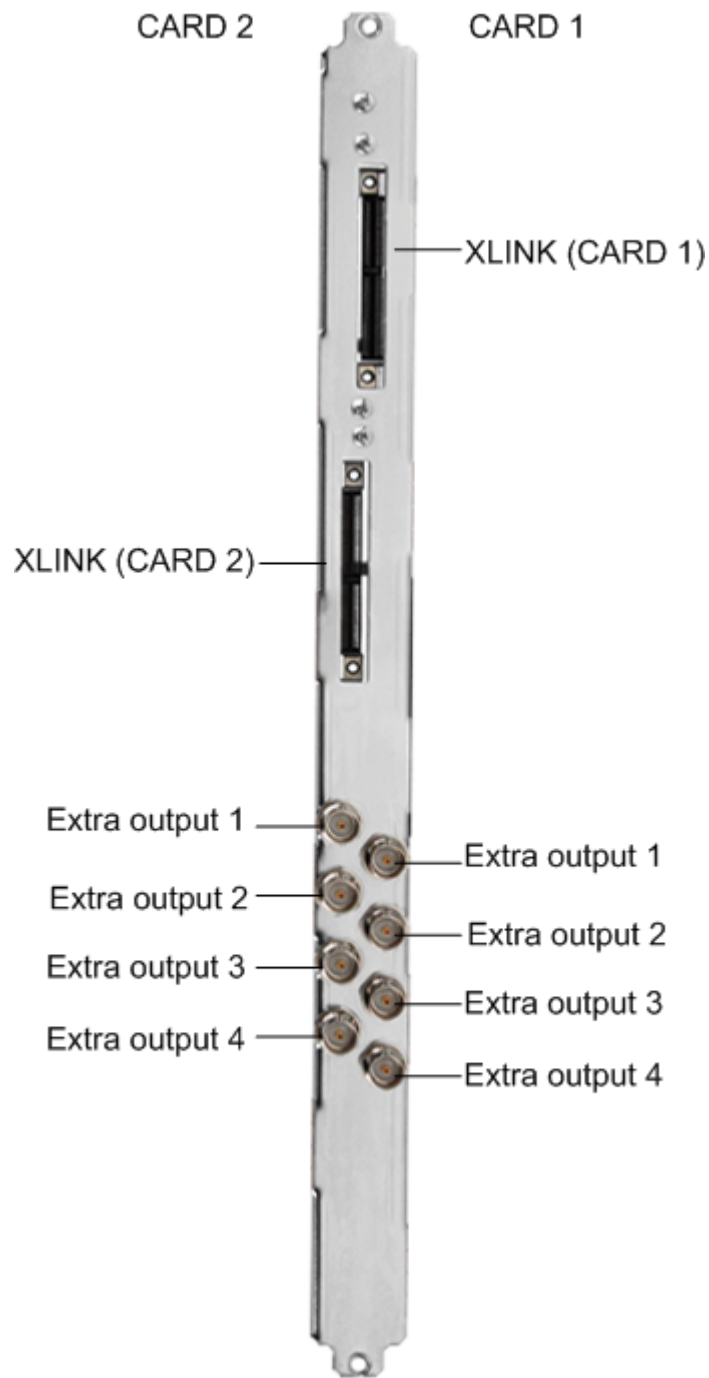

Figure 6-23 : XLINK Output RP Top Slot

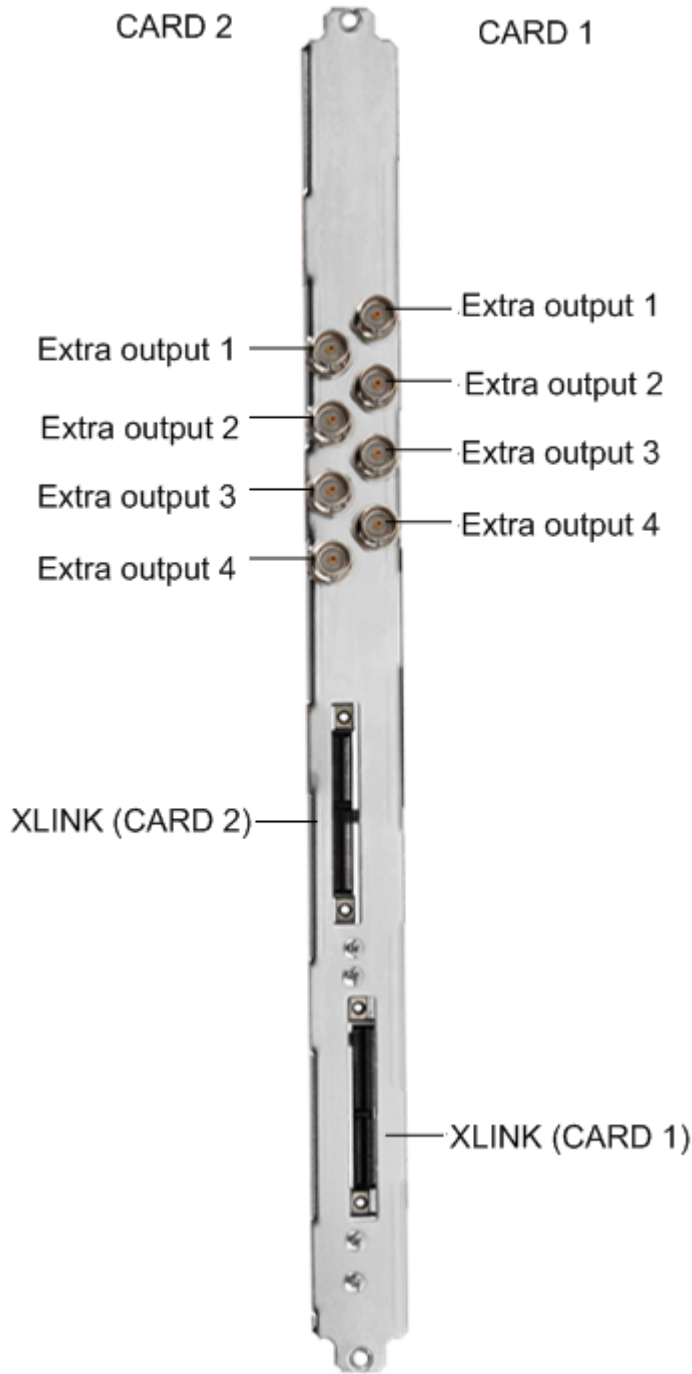

Figure 6-24 : XLINK Output RP Bottom Slot

6.4.7 EQX-OP18-3G-XLINK RP – Key Features

- Completely passive module
- Each RP carries 2 XLINKS outputs and 4 DIN 1.0/2.3
- RP can be hot-swapped

Each RP supports 2 (two) modules of 18 channels. Each Xlink carries 16 channels and XLINK-BHP-5-EQX1FR split cable is used, to combine the outputs of both modules to a single 32 channels Xlink output. DIN connectors are outputs 17 and 18 or 1 and 2 of each module based on location of the RP.

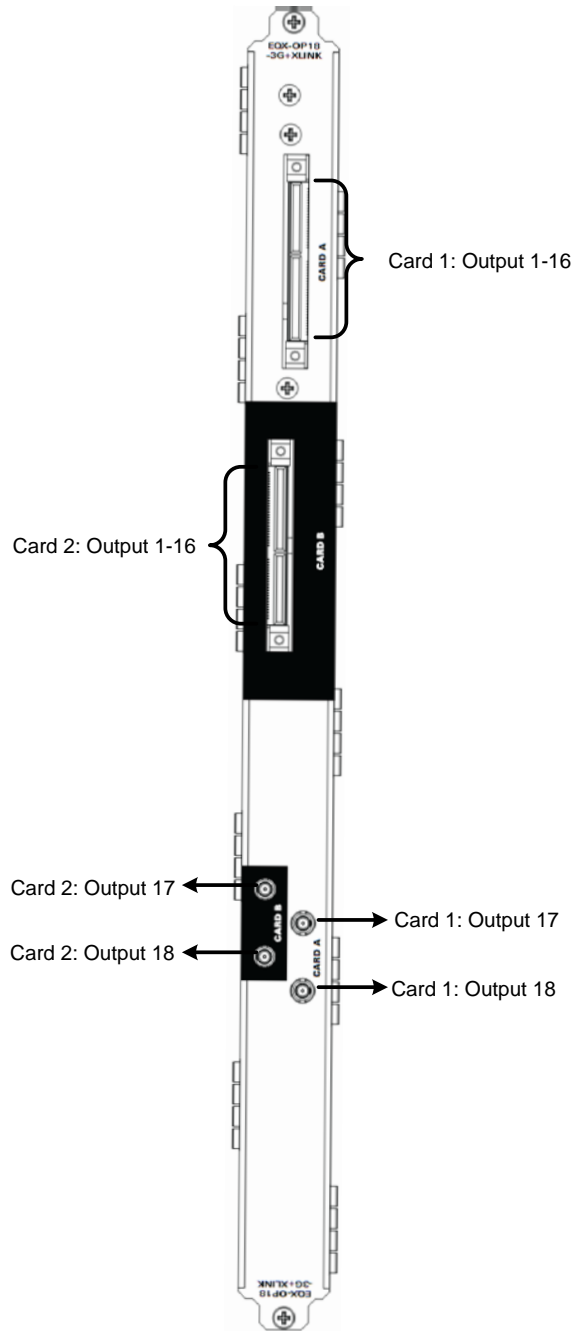

Figure 6-25 : EQX-OP18-3G-XLINK RP (Top Slot)

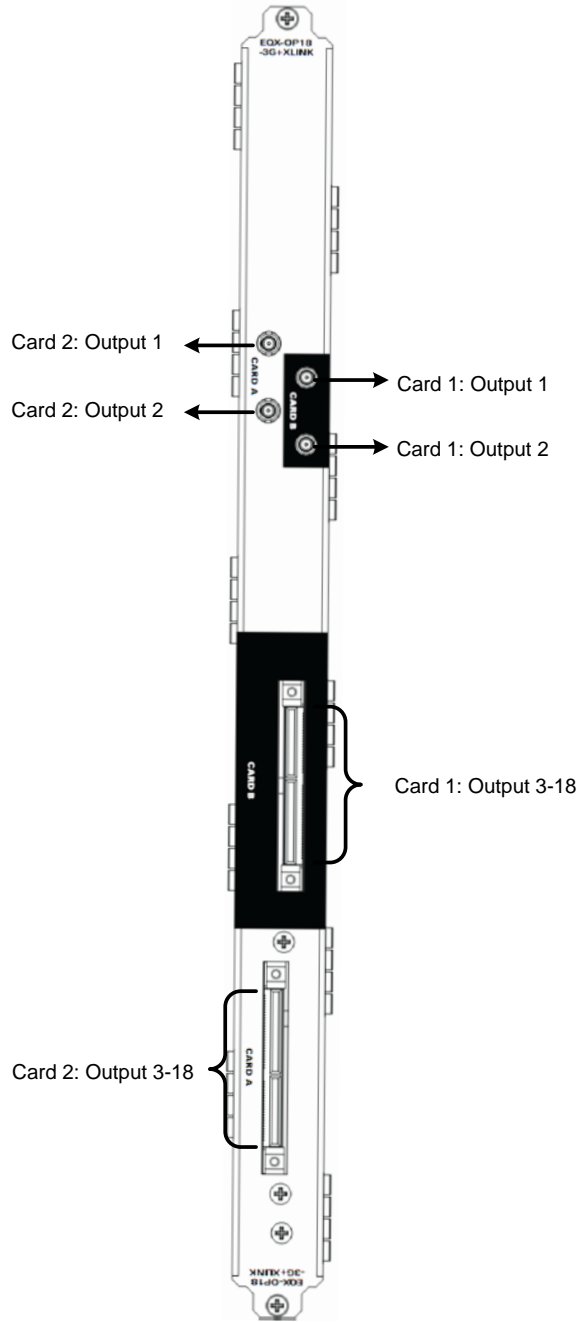

Figure 6-26 : EQX-OP18-3G-XLINK RP (Bottom Slot)



Note: When the rear plate is installed in the top slots, the shaded connectors are reserved for the card on the left side and when the rear plate is installed in the bottom slots the shaded connectors are reserved for card on the right side.

6.4.8 Double Density Output RP - Key Features

- Completely passive module
- Each RP carries 36 DIN 1.0/2.3 connectors
- All I/O RPs can be hot-swapped

Each RP supports 2 (two) modules of 18 channels each.

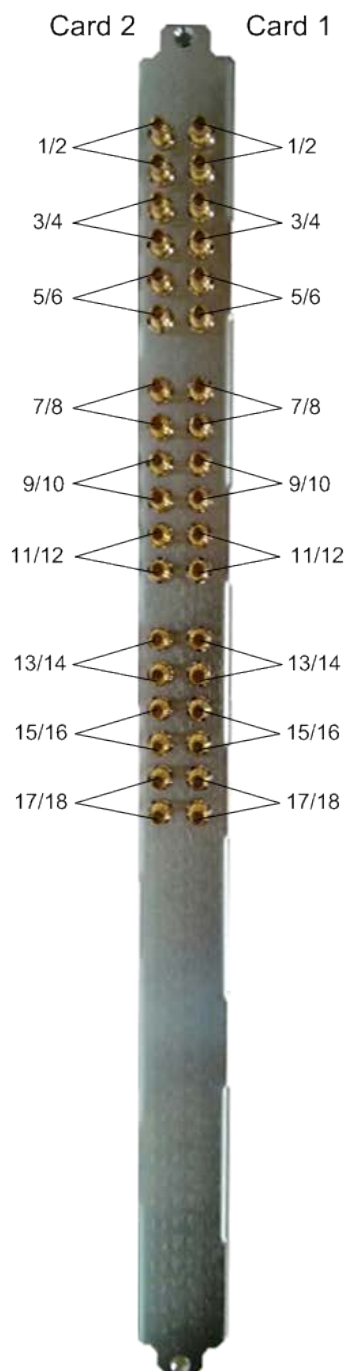

Figure 6-27 : EQX-IO18-DIN-RP

6.4.9 Double Density Output RP - Key Features

- Completely passive module
- Each RP carries 72 DIN 1.0/2.3 connectors
- All I/O RPs can be hot-swapped

Each RP supports 2 (two) modules of 36 channels each.

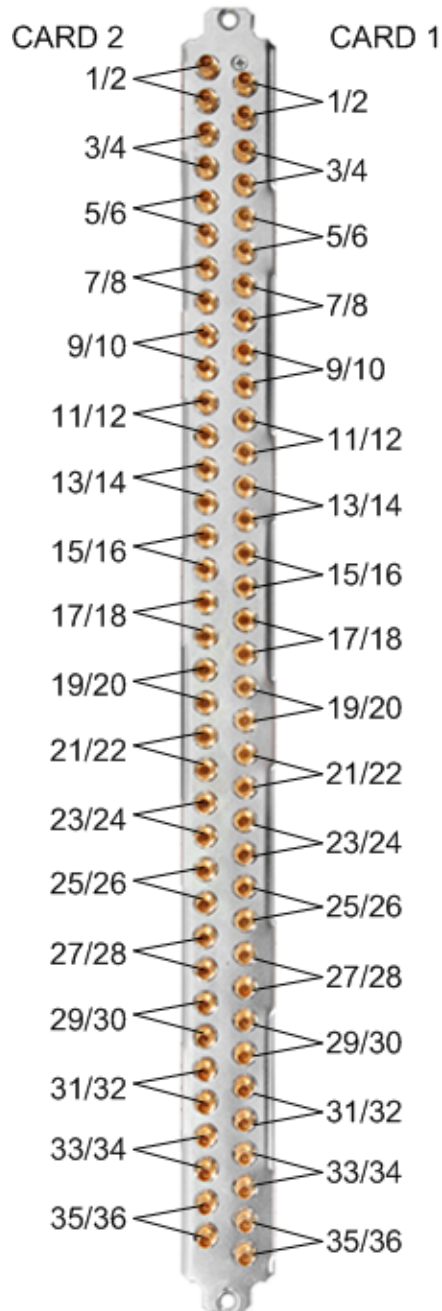

Figure 6-28 : Double Density I/O RP

6.4.10 EQX-IP18FSAD-3G RP - Key Features

- Completely passive module
- Each RP carries 80 DIN 1.0/2.3 connectors
- All FS RPs can be hot-swapped

Each RP supports 2 (two) modules of 18 channels each.

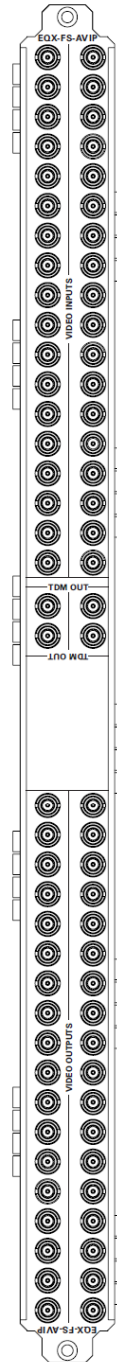

Figure 6-29 : EQX-IP18FSAD-3G

6.4.11 EQX-IP18AD-3G-XLink-RP8 RP - Key Features

- Completely passive module
- Each RP carries 10 X-Link connectors for Video I/O and 32 DIN 1.0/2.3 connectors for TDM I/O
- All AVIP RPs can be hot-swapped

Each RP supports 8 (eight) modules of 18 channels each.

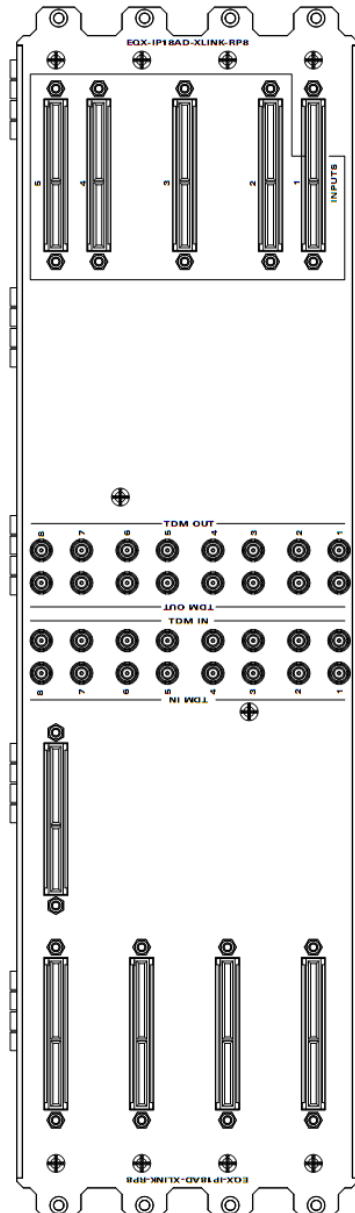

Figure 6-30 : EQX-IP18AD-3G-XLink-RP8



Note: XLink-RP8 and IP18FSAD rear plates are not compatible with normal input modules. They are compatible with EQX-IP18AD-3G and EQX-IP18FSAD-3G input modules only.

6.4.12 EQX-IP18-XLink-RP8 - Key Features

- Completely passive module
- Each RP carries 5 X-Link connectors for Video Input
- All XLINK RPs can be hot-swapped

Each RP supports 8 (eight) modules of 18 channels each.

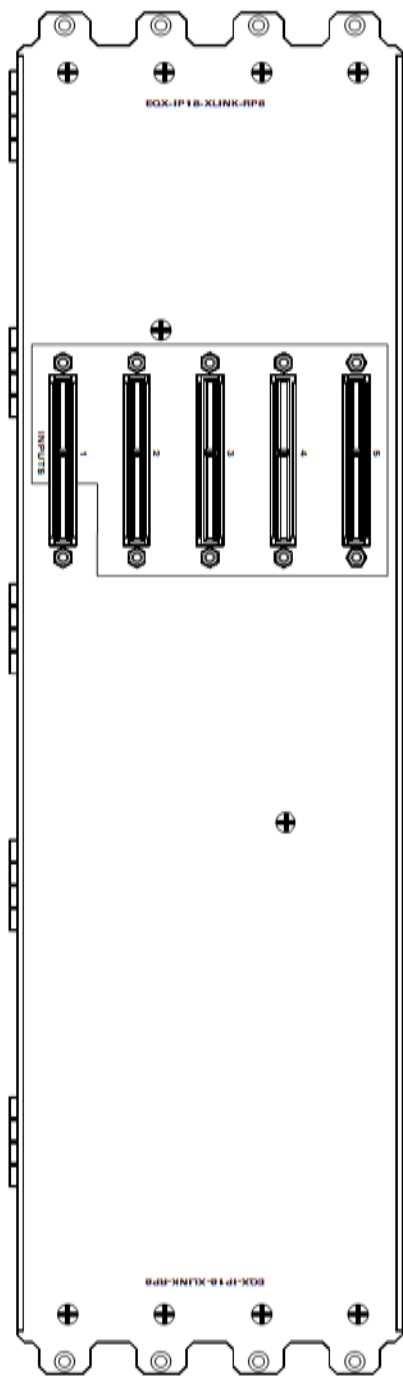

Figure 6-31 : EQX-IP18-XLINK-RP8

6.4.13 EQX-IP18-XLink-EX-RP8 - Key Features

- Completely passive module
- Each RP carries 5 X-Link connectors for Video Input and 5X-Link connector for Video Out
- All XLINK RPs can be hot-swapped

Each RP supports 8 (eight) modules of 18 channels each.

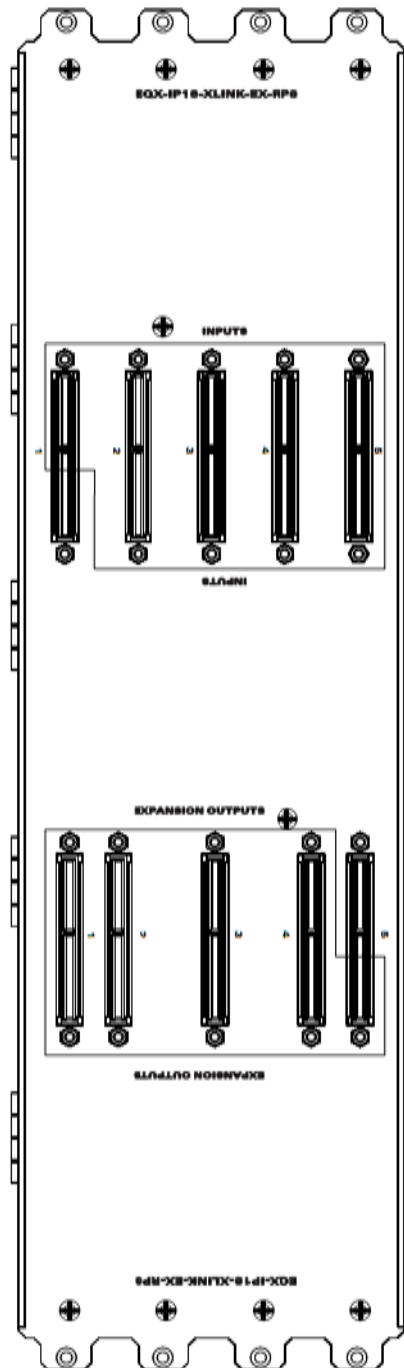

Figure 6-32 : EQX-IP18-XLINK-EX-RP8

6.4.14 XIO (DD) Output DIN RP8 - Key Features

- Completely passive module
- Each RP carries 144 DIN 1.0/2.3 and 5 X-Link connectors
- All output RPs can be hot-swapped

Each RP supports 8 (Eight) modules of 36 channels each.

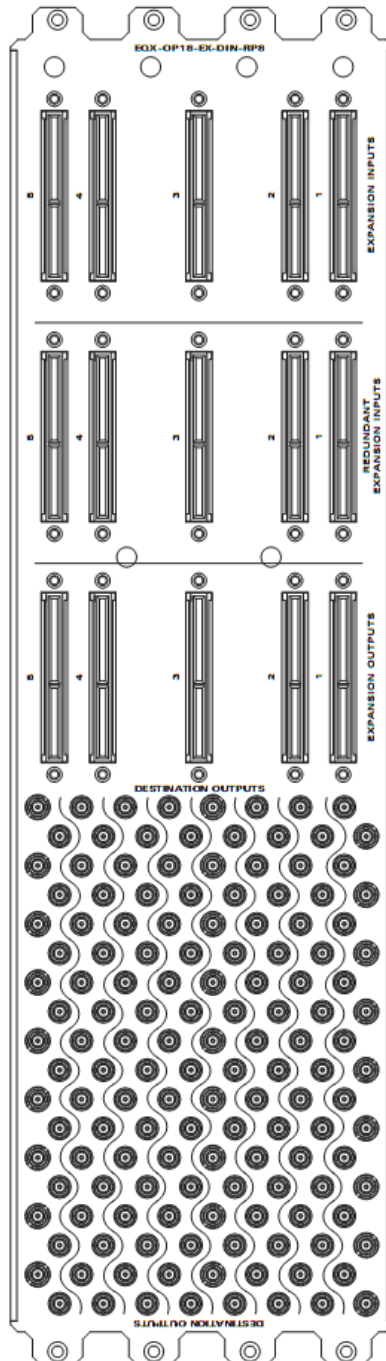

Figure 6-33 : EQX-OP18-DIN-RP8

6.4.15 XIO (DD) Output X-Link RP - Key Features

- Completely passive module
- Each RP carries 10 X-Link connectors
- All output RPs can be hot-swapped

Each RP supports 8 (Eight) modules of 36 channels each.

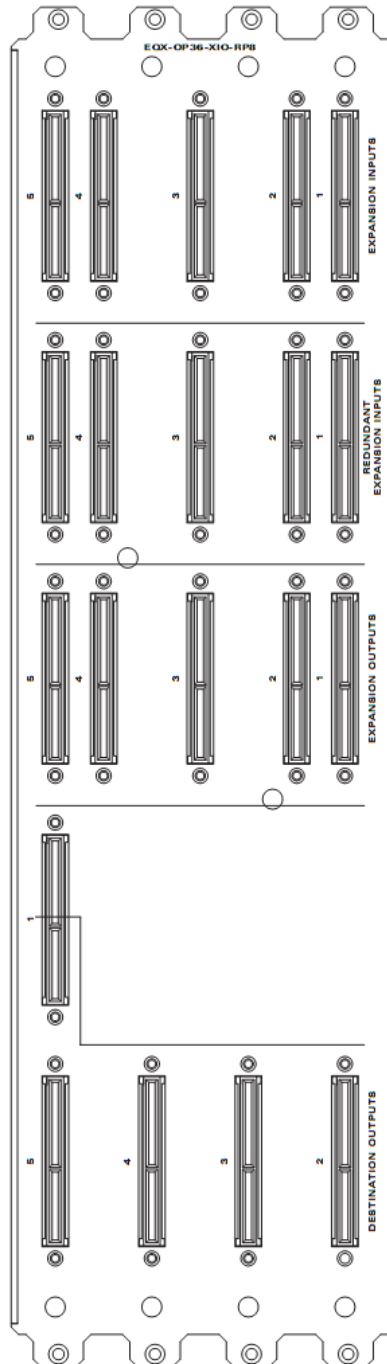

Figure 6-34 : EQX-OP36-XLINK-RP8



Note: In RP8 the expansion X-Link Inputs are used for multi-frame systems only.



Note: RP8 rear plates are not compatible with normal output modules. They are compatible with EQX-OP36-3G/H-XIO and EQX-OP18-3G-EX output modules only.

6.5 XLINK CABLES

The X-LINK cable provides a high-density extension of the additional outputs from the routers to other XLINK connections. The standard X-LINK cable length provided with all X-LINK enabled products is 5 meters (15 feet).

6.5.1 X-LINK cable part numbers:

- **XLINK-BHP-5:** Five meter X-LINK cable (standard)
- **XLINK-BHPS-5:** Five meter split X-LINK cable for Frame Expansion split connection (FX connectors 5 & 14, labeled 'odds' and 'evens').
- **XLINK-BHP-5 to BNC:** 5m XLINK cable to standard BNC's. No breakout panel required.
- **XLINK-BHP-5-EQX1FR:** Five meter split X-LINK cable. Used to connect ½ connector outputs from MAIN outputs to XLINK VIP/MVP (1-16 to 1-16, 17-32 to 1-16). Also used with the 1RU EQX audio frame family.
- **XLINK-32DIN-5:** Five meter X-LINK to DIN breakout cable. Used to connect Redundant Expansion Outputs to DIN VIP/MVP outputs.



Figure 6-35 : X-LINK-BHP-5



Figure 6-36 : XLINK-BHPS-5/BHP-5-EQX1FR



Figure 6-37 : 7 XLINK-BHP-5 to BNC

6.6 XLINK BREAK-OUT PANELS

6.6.1 XLINK-BHP2U-96C

XLINK-BHP2U-96C is a breakout panel with three (3) X-LINK inputs on the rear of the BHP and 96 standard coax connectors on the front. Each X-LINK input is converted to a total of 32 BNCs. The panel is 19" rack mountable and requires 2RU of rack space. The panel ships with three special 1m (3 feet) cables (no substitutions can be made).

The XLINK-BHP2U-96C can be used to convert X-LINK into a standard coax connection. These coax connectors can then be used to feed monitoring equipment, Evertz does not recommend the use of this BHP to feed downstream equipment expecting SMPTE standard video signals. Evertz makes no claims that the coax copy of X-LINK video will meet the SMPTE standards for SD, HD or 3Gbps. The BHP panel can be used to extend X-LINK by converting to standard coax cable (Belden 1694A or comparable cable) and offering extension up to 50m (150 feet).



Figure 6-38 : XLINK-BHP2U-96C

6.6.2 XLINK-BHP1U-96DIN

XLINK-BHP1U-96DIN is a breakout panel with three (3) X-LINK inputs on the rear of the BHP and 96 DIN connectors on the front.

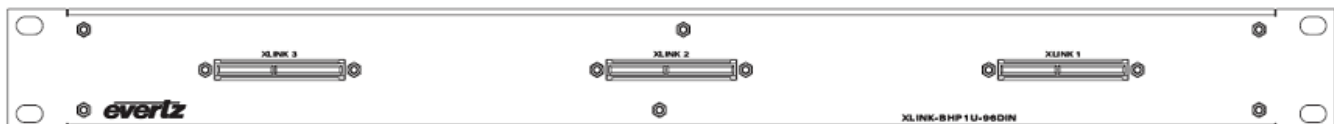

Figure 6-39 : XLINK-BHP1U-96DIN

6.6.3 XLINK-BHP4U-288DIN

XLINK-BHP4U-288DIN is a breakout panel with X-LINK inputs on the rear of the BHP and 288 DIN connectors on the front. Each X-LINK input is converted to a total of 32 DINs. The panel is 19" rack mountable and requires 4RU of rack space.

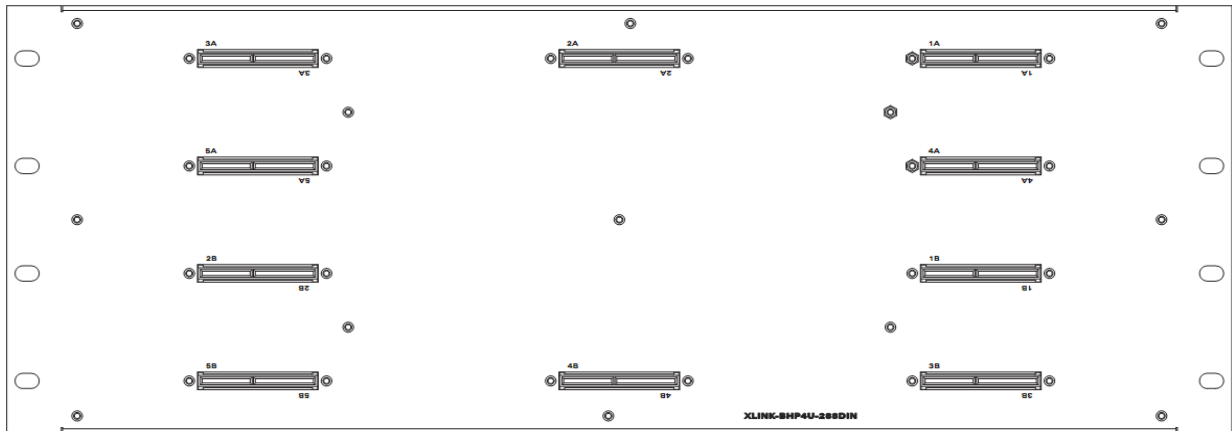

Figure 6-40 : XLINK-BHP4U-288DIN

6.6.4 XLINK-BHP4U-288DIN-1X2

XLINK-BHP4U-288DIN-1X2 is a splitter/combiner break out panel with X-LINK inputs on the rear of the BHP and 288 DIN connectors on the front. Each X-LINK input is converted to a total of 32 DINs. This panel is used for systems greater than 1152x1152. The panel is 19" rack mountable and requires 4RU of rack space. Termination boards are required for unused X-LINK connections.

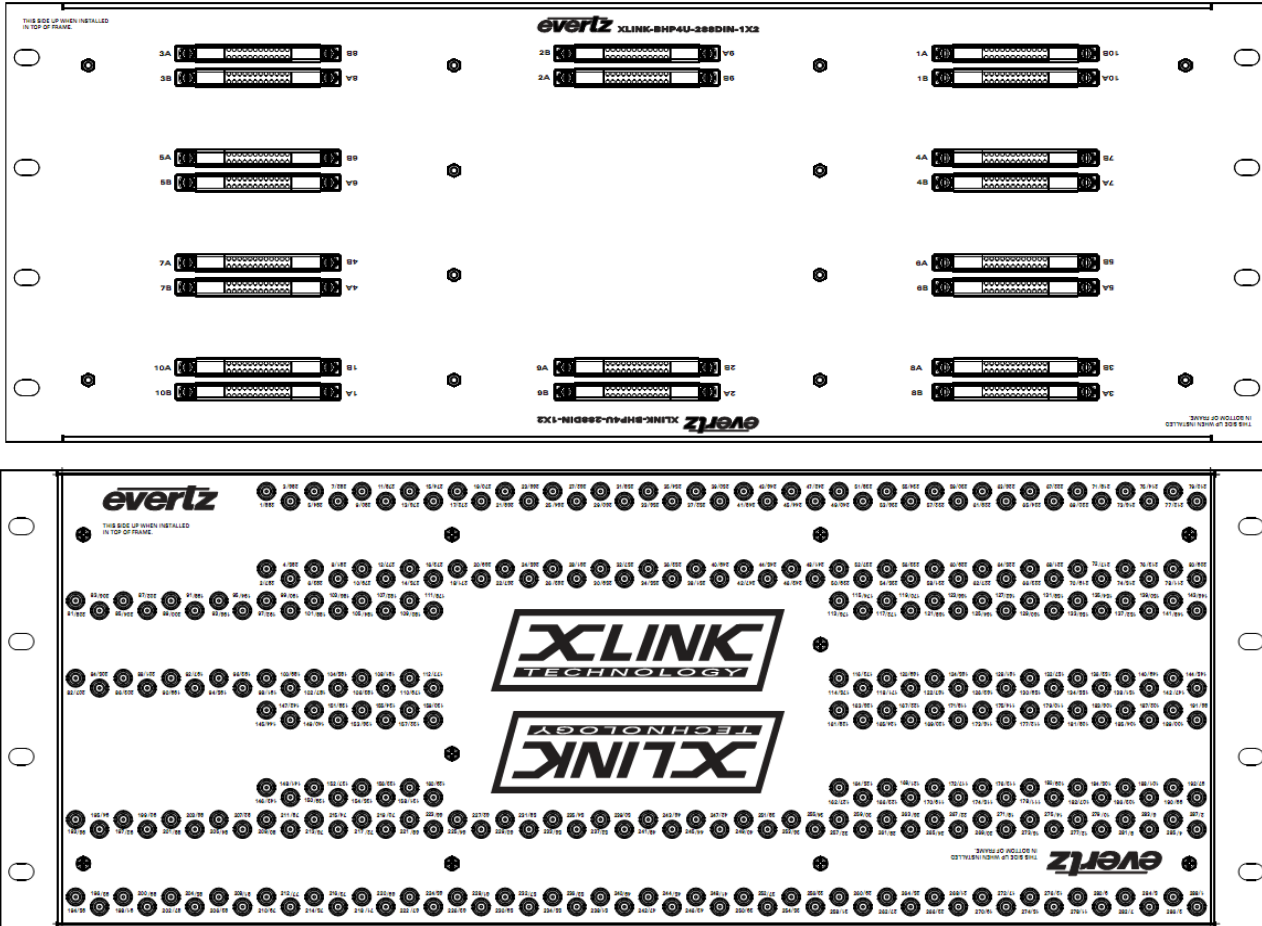

Figure 6-41 : XLINK-BHP4U-288DIN-1X2



Note: XLINK-BHP4U-288DIN-1X2 is used on custom systems, contact factory for more information.

7 CONTROL AND MONITORING MODULES

7.1 EQX FRAME CONTROLLER

The EQX router is fitted with an internal Frame Controller.

This frame controller manages all of the external and internal router communications from the remote control panels and third party devices, such as automation systems.

The standard EQX configuration requires a single frame controller; however, a second frame controller can be fitted to provide full redundancy.

Both the main and redundant controllers will automatically synchronize the router’s crosspoint database, allowing the redundant frame controller to instantly take over should the main frame controller fail.

Within the EQX router, the main internal and inter-frame communications are managed by F-Link. The frame control will automatically convert all Q-Link, Ethernet (for crosspoint switching) and Serial communications to F-Link.

The Frame Controllers are accessed from the front of the frame and can be replaced one at a time while the EQX router is still operational should one of the modules fail.

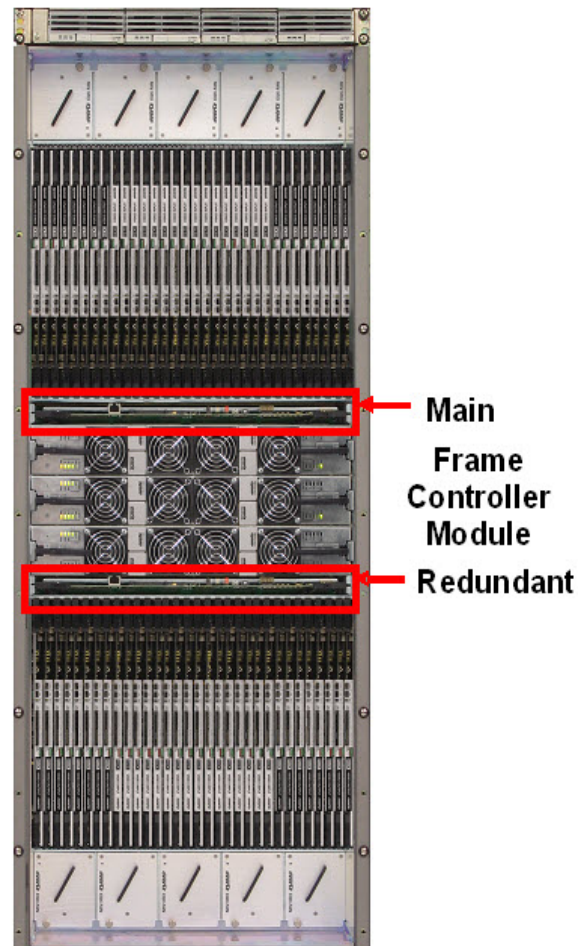

7.1.1 Frame Controller - Key Features

- Manages all internal and external router communications
 - F-Link (Internal and Inter-frame communications)
 - Q-Link (Remote Control Panels)
 - Ethernet (Automation systems and Magnum)
 - Serial RS422/232 (Automation systems)
 - F-Link & Ethernet ports on all active modules
- The redundant frame controller ensures continuous operation (optional)
- Full SNMP enabled



Note: All three frames 26RU, 16RU and 10RU are sharing the same Frame controllers.

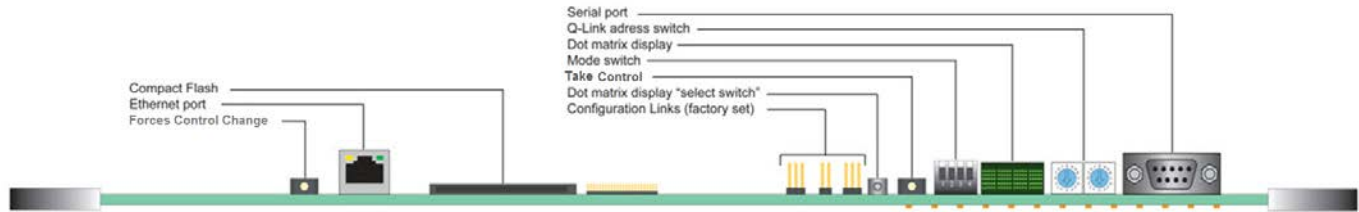

Figure 7-1 : Frame Controller Module Card Edge Controls and Connectors

Switch	Function
Hex Dials	Sets the FC Q-Link ID
Take Control	This function has been disabled in the newer builds
Toggle Switch	Toggle to the left for IP Addresses.
	Toggle to the right for Configuration Name.
LED	Function
Dot Matrix Display	Displays IP addresses and Configuration name
Mode Dip Switch	Function
Mode Switch 1	Not used.
Mode Switch 2	Fan speed selection. Up = Automatic Down = High
Mode Switch 3	Activate on board control.
Mode Switch 4	Not used.

Table 7-1 : EQX Frame Controller Switch Functions



Note: The Q-Link address for the TOP FC has to be set to (00) and for the BOTTOM FC it has to be set to (01)

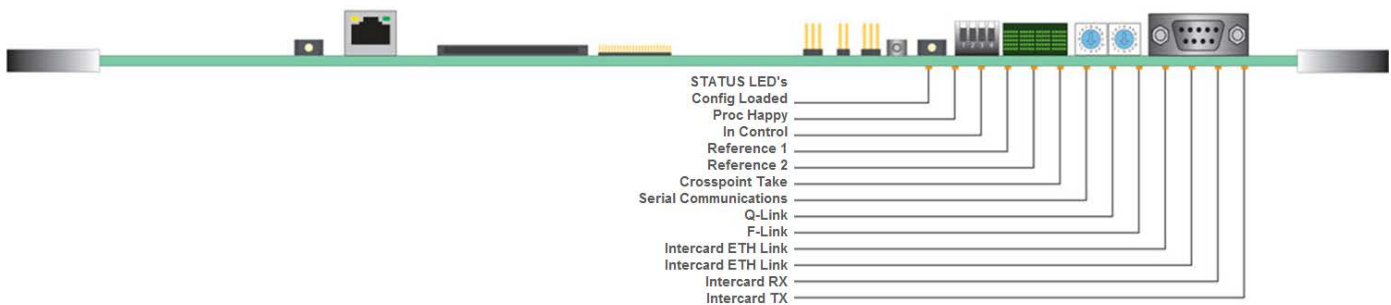

Figure 7-2 : Frame Controller Module Status LEDs

LED	Colour	Function
Config Loaded	Green	This LED indicates that a config is loaded.
Proc Happy	Green	Flashes when the frame controller processor is working correctly. Turns off when a fault condition has been detected.
In Control	Green	This LED indicates which of the two frame controllers within a redundant system is currently in control.
Reference 1	Green	Indicates that a valid reference signal is present. (Steady for 50.00Hz and flashing for 59.94Hz)
	Red	Indicates that the reference signal is invalid or missing, and is required for the current configuration.
Reference 2	Green	Indicates that a valid reference signal is present. (Steady for 50.00Hz and flashing for 59.94Hz)
	Red	Indicates that the reference signal is invalid or missing, and is required for the current configuration.
Crosspoint Take	Green	The LED flashes when a crosspoint take command is acted upon.
Serial Communications	Green	TX data. Flashes when the frame controller transmits data.
	Red	RX data. Flashes when the frame controller receives data.
Q-Link	Green	Indicates that the Q-Link is operating correctly.
	Red	Indicates that an error has been detected with the Q-Link.
F-Link	Green	Indicates that the F-Link is operating correctly.
	Red	Indicates that an error has been detected with the F-Link.
Intercard ETH Link	Green	Indicates that there is an intercard Ethernet network link.
Intercard ETH Link	Green	Indicates that there is an intercard Ethernet network link.
Intercard RX	Green	Indicates that there is an intercard network link RX.
Intercard TX	Green	Indicates that there is an Intercard network link TX.

Table 7-2 : LED Description Of Frame Controller Module

7.2 EQX COMMUNICATION PORTS

- 2x Ethernet Ports (1A and 1B)
- 2x F-Link Ports
- 4x Q-Link Ports
- 4x Serial Ports (RS422/232)
- 2x PSU Comms Ports
- 2x Alarm Ports

The Ethernet and Serial ports are used for automation control, remote control panels, router configuration and SNMP monitoring.

The Q-Link ports are used for the connection of the Quartz remote control panels.

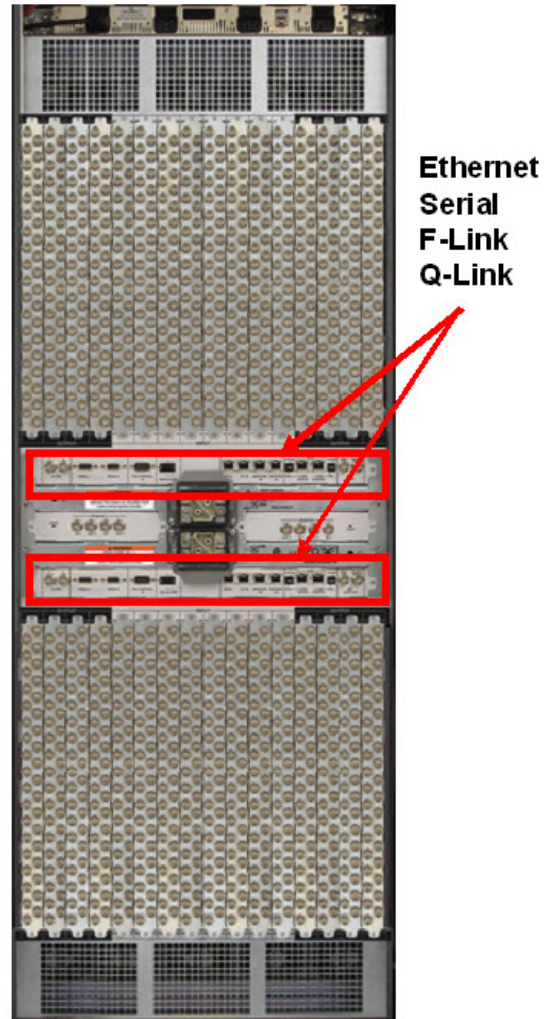

Figure 7-3 : F-LINK and Q-LINK Connectors

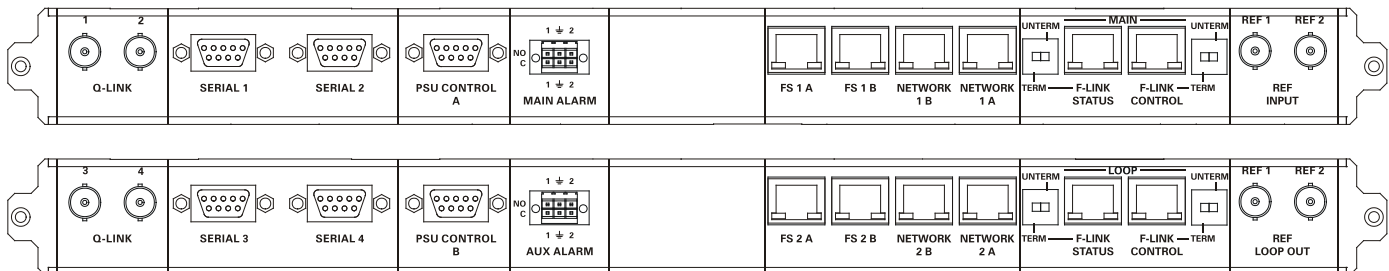

Figure 7-4 : EQX 26RU and 16RU Communication Ports

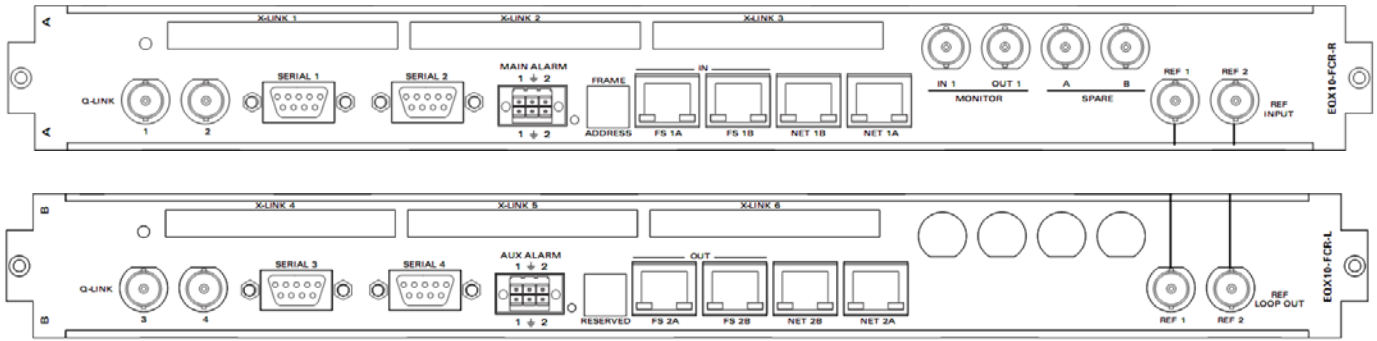

Figure 7-5 : EQX10 Communication Ports

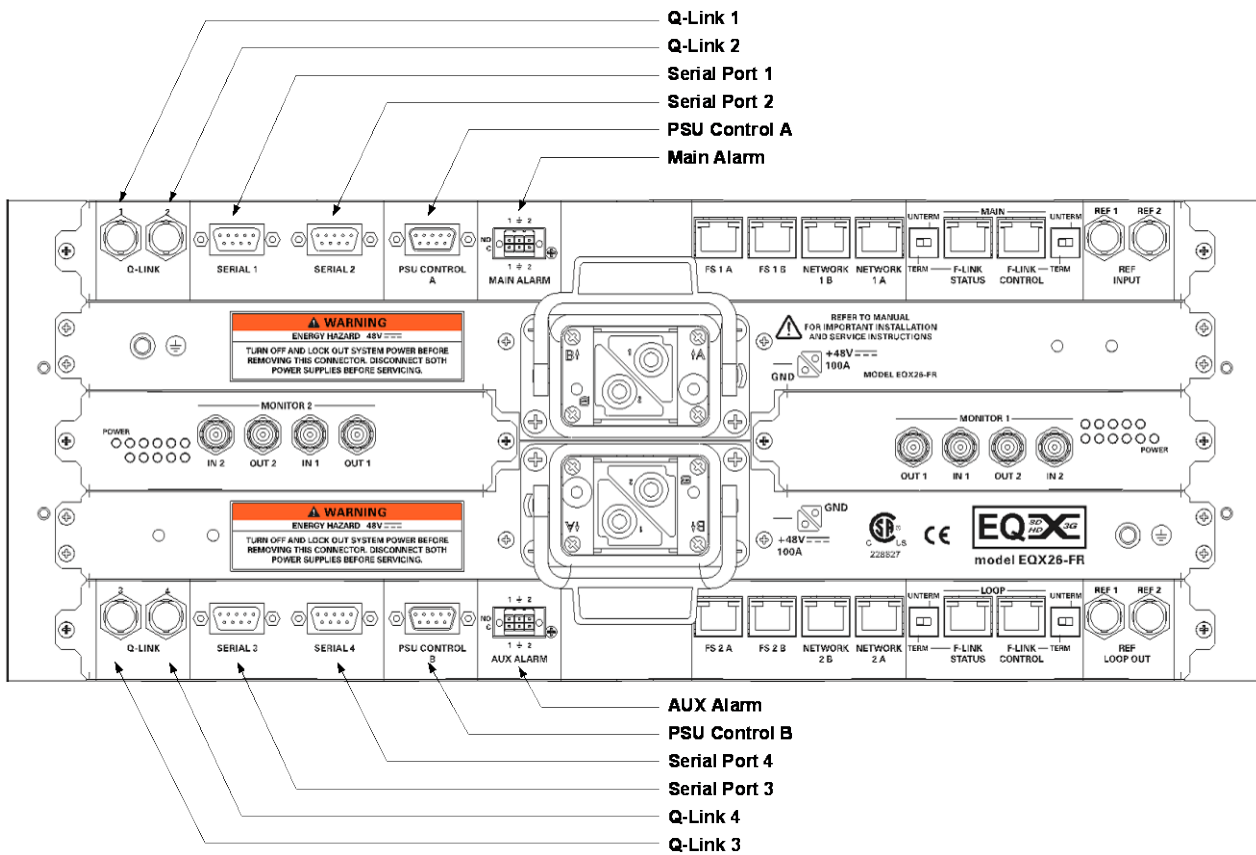

Figure 7-6 : Communication RP for 26RU and 16RU frames

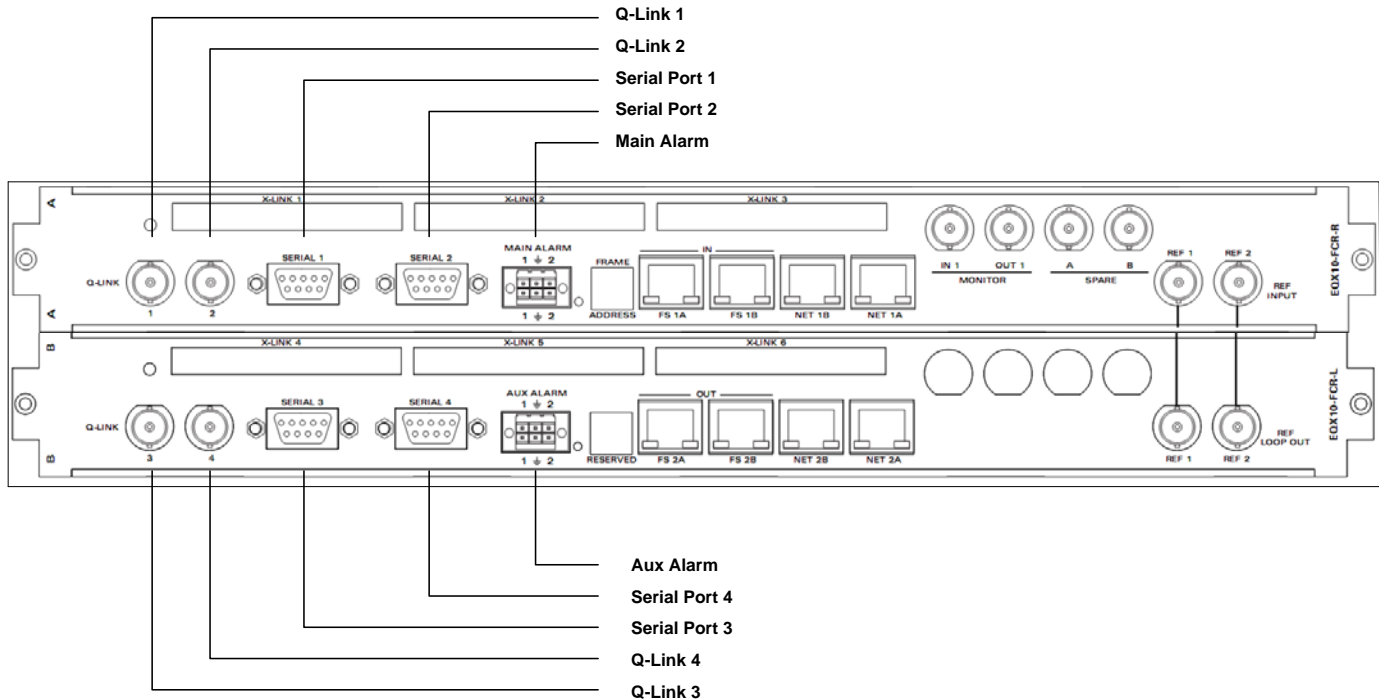

Figure 7-7 : Communication RP for EQX10 frames

7.2.1 Upper Communication RP (Left Side)

- Q-Link 1:** Q-Link serial communication port used to connect remote control panels, external system controllers or slaved Quartz brand routers.
- Q-Link 2:** Q-Link serial communication port used to connect remote control panels, external system controllers or slaved Quartz brand routers.
- Serial Port 1:** RS-422/RS-232 serial communication port used to connect WinSetup configuration application (recommended) or 3rd party control devices such as automation systems or devices requiring a UMD feed (for example, an MVP). RS-422 or RS-232 mode is configured by a link on the Frame Controller.
- Serial Port 2:** RS-422/RS-232 serial communication port used to connect 3rd party control devices such as automation systems or devices requiring a UMD feed (for example, an MVP). RS-422 or RS-232 mode is configured by a link on the Frame controller.
- PSU Control A:** Not Used (26RU and 16RU only)
- Main Alarm:** External alarm connection which is used to indicate a fault condition.

7.2.2 Lower Communication RP (Left Side)

- Aux Alarm:** External alarm connection which is used to indicate a fault condition.
- PSU Control B:** Not Used (26RU and 16RU only)
- Serial Port 4:** RS-422/RS-232 serial communication port used to connect 3rd party control devices such as automation systems or devices requiring a UMD feed (for example, an MVP). RS-422 or RS-232 mode is configured by a link on the Frame controller.
- Serial Port 3:** RS-422/RS-232 serial communication port used to connect 3rd party control devices such as automation systems or devices requiring a UMD feed (for example, an MVP). RS-422 or RS-232 mode is configured by a link on the Frame Controller.
- Q-Link 4:** Q-Link serial communication port used to connect remote control panels, external system controllers or slaved Quartz brand routers.
- Q-Link 3:** Q-Link serial communication port used to connect remote control panels, external system controllers or slaved Quartz brand routers.

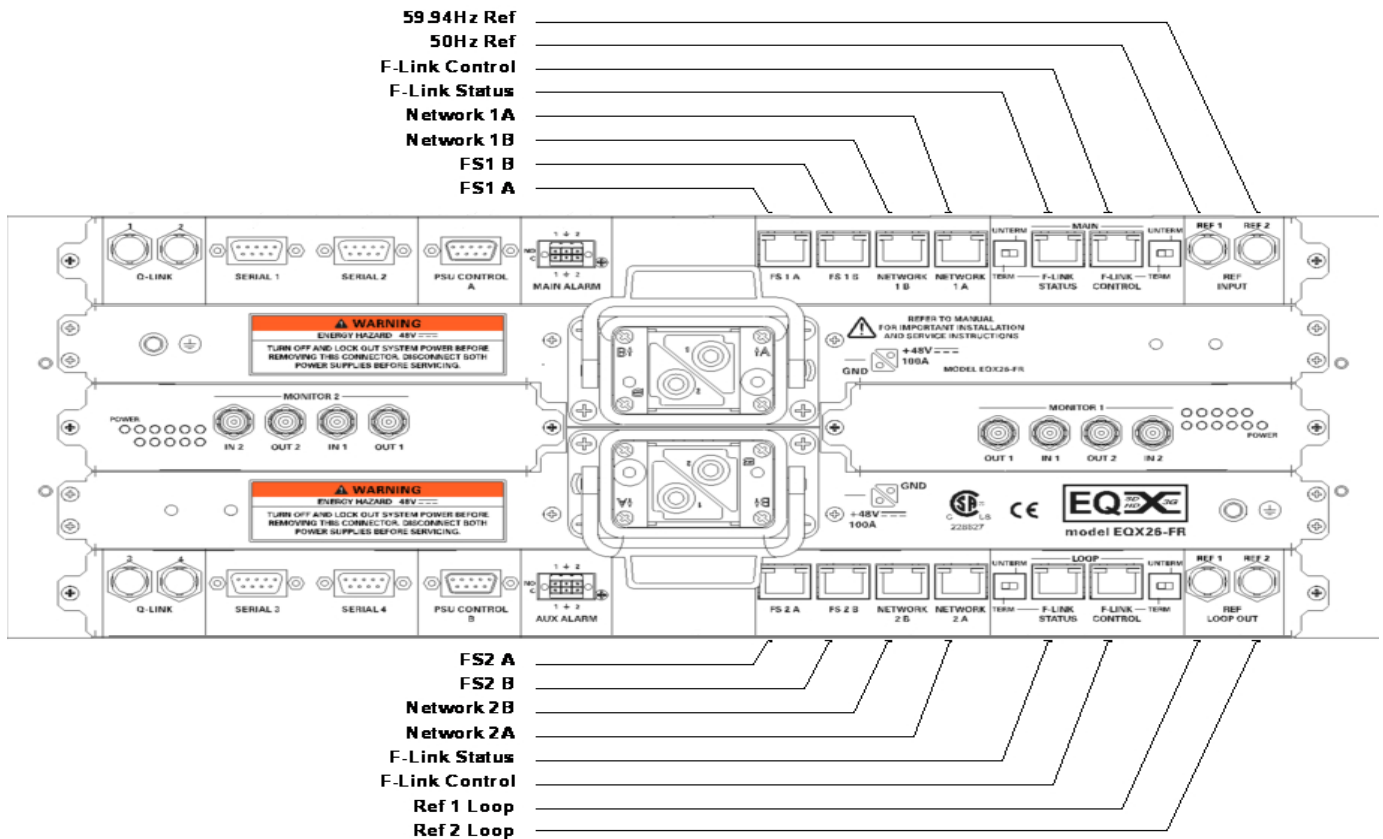

Figure 7-8 : Communication RP for 26RU and 16RU frames

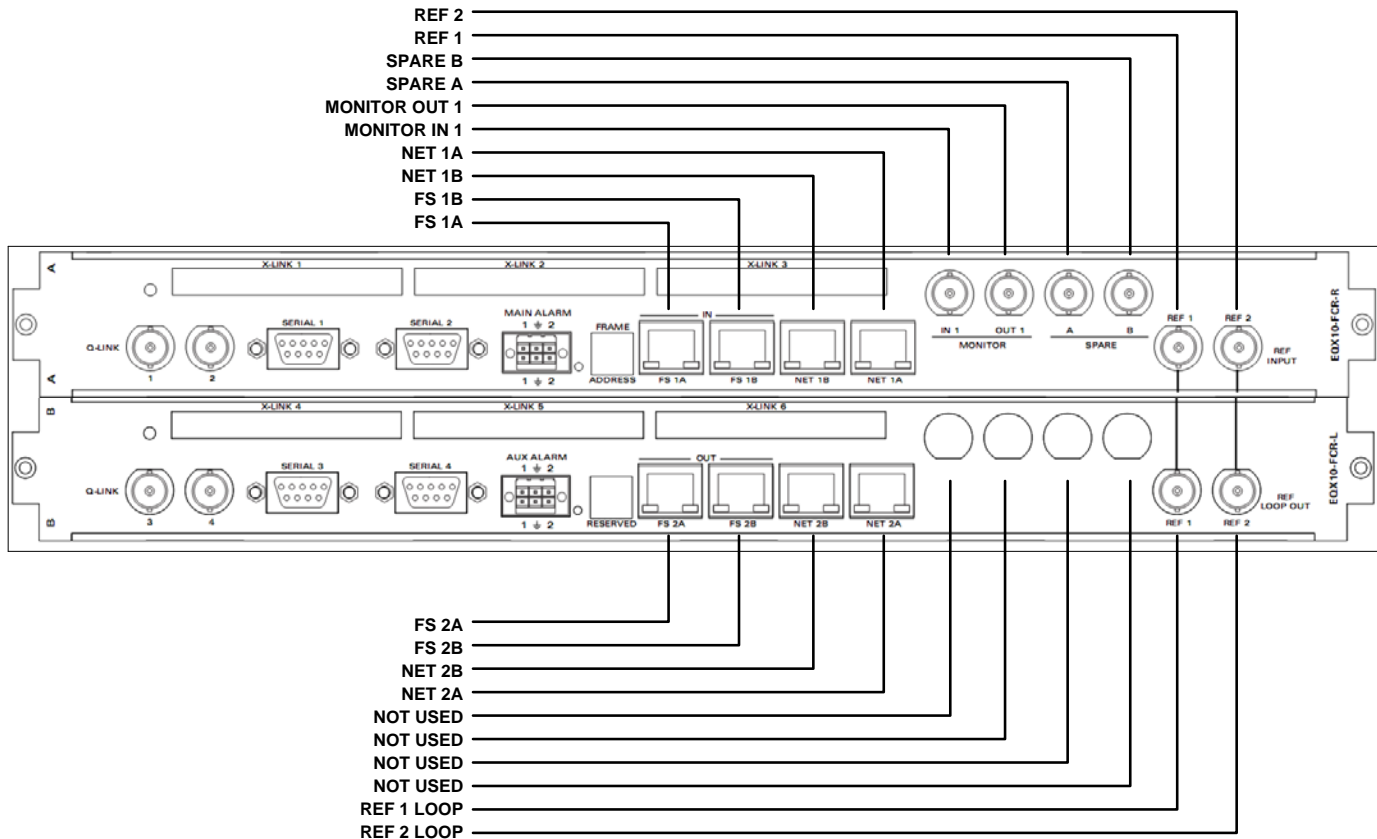

Figure 7-9 : Communication RP EQX10

7.2.3 Upper Communication RP (Right Side)

REF 1/REF 2: Used to connect a 50Hz or 59.94Hz genlock signal. Any genlock signal at 59.94Hz (or 50Hz) (Bi-level or Tri-Level) can be used to switch any 59.94Hz (or 50Hz) signal. The Reference Module inside the router’s Frame Controller can generate up to 4 different timing planes based on the type of genlock supplied and the frequency of the signals being switched (IE supplying a 59.94Hz Bi-Level genlock, the reference module can generate 720p/60, 1080i/60, 525/60, 1080p/60 internally).

F-Link Control: Not used (26RU and 16RU only).

F-Link Status: Not used (26RU and 16RU only).

Spare A/B: Not used (EQX10 only)

Monitor Output1: Used to monitor all input and output (10RU only)

Monitor Input1: Not used (EQX10 only)

Network 1A: 100Mb Ethernet connection used for Ethernet based control systems such as remote control panels, external system controllers, 3rd party control devices, etc.

Used for router control only.

Network 1B: 1GB Ethernet connection for SNMP/Thumbnail/Streaming traffic directly from the internal modules out to the network

FS1 B: Not used.

FS1 A: Not used.

7.2.4 Lower Communication RP (Right Side)

FS2 A: Not used.

FS2 B: Not used.

Network 2B: 1GB Ethernet connection for SNMP/Thumbnail/Streaming traffic directly from the internal modules out to the network

Network 2A: 100Mb Ethernet connection used for Ethernet based control systems such as external system controllers, 3rd party control devices, etc.
Used for router control only.

F-Link Status: Not used (26RU and 16RU only).

F-Link Control: Not used (26RU and 16RU only).

REF 1/REF 2 Loop: Is the loop out of the primary reference inputs.

7.3 EQX REFERENCE INPUT

The internal timings and switch points for all three EQX routers are generated from their signal feed to their reference input.

The EQX will accept either Bi-level or Tri-Level syncs, from which it is able to generate the required timing for switching SD and HD digital video signals.

From this single reference signal the EQX can generate four independent timing levels, which provides SMPTE compliant switching for four different digital video standards within the same frame.

- SD Digital Video:
 - 525
 - 625

- HD Digital Video (at 50 to 60 Hz):
 - 720p
 - 1080i
 - 1080p
 - Plus others...

By supplying a second video reference at a different frequency to the first, the EQX is able to generate timing levels at both frequencies, for example 50Hz and 60 Hz.

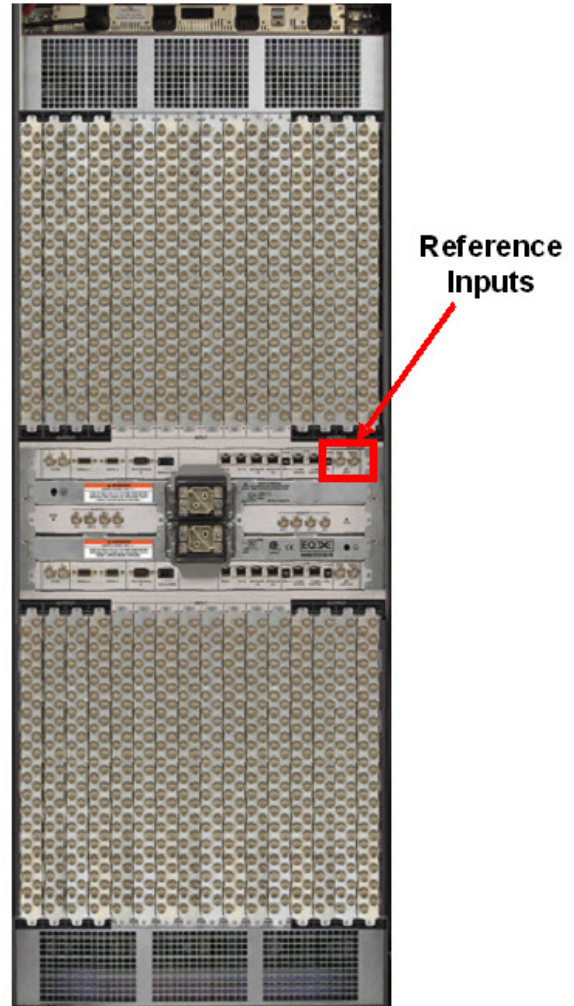

Note: Do not connect two of the same reference type, i.e. two 50Hz references.

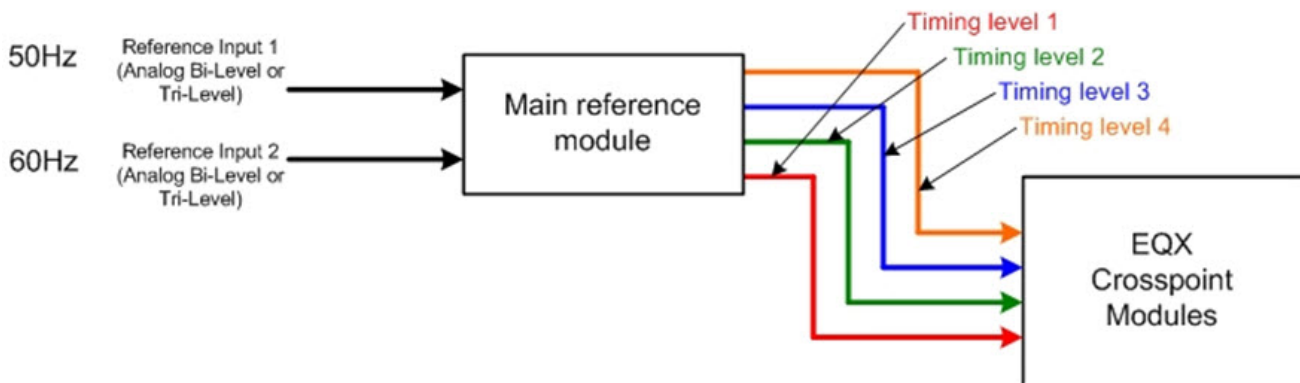

Figure 7-10 : EQX Reference Input

7.3.1 Reference Input - Key Features

- Two bi-level or tri-level reference inputs (SD/HD at 50Hz to 60Hz).
- Four independent timing levels for SMPTE compliant switching of up to four different digital video signals.
- Supports mixed digital video standards at mixed frequencies.

7.4 EQX 26RU AND 16RU MONITORING OUTPUTS

The EQX router supports signal monitoring of all of the video inputs and outputs via dedicated BNC connectors on the rear of the EQX frame. The EQX also incorporates comprehensive system status monitoring, including power supply voltages, interior temperatures and fan speeds. Monitored data is available through SNMP for facility-wide monitoring systems. System status may also be monitored remotely by a network based remote connection over TCP/IP. User configurable closing contacts are also provided for connection to an external alarm system.

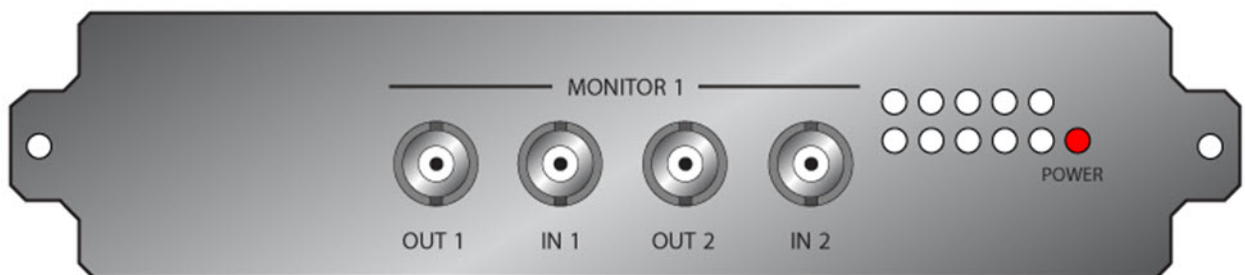
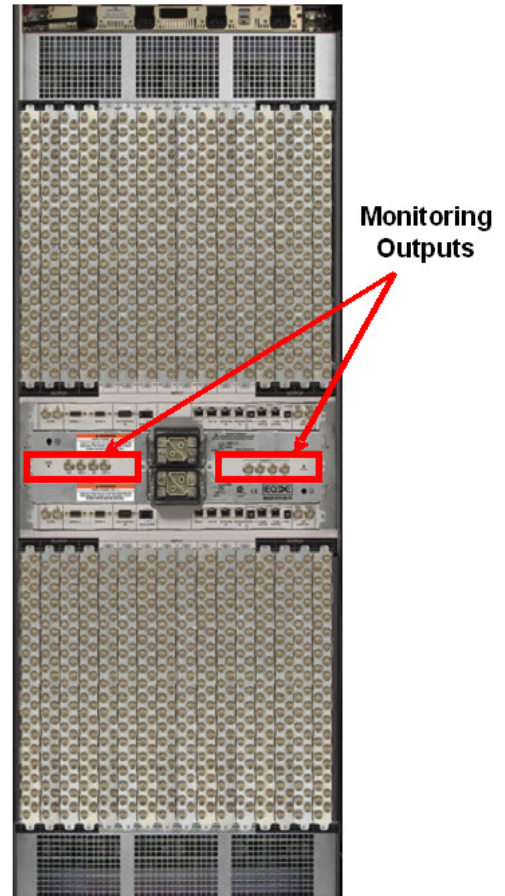

Figure 7-11 : Monitor 1 (Right Side of Frame)

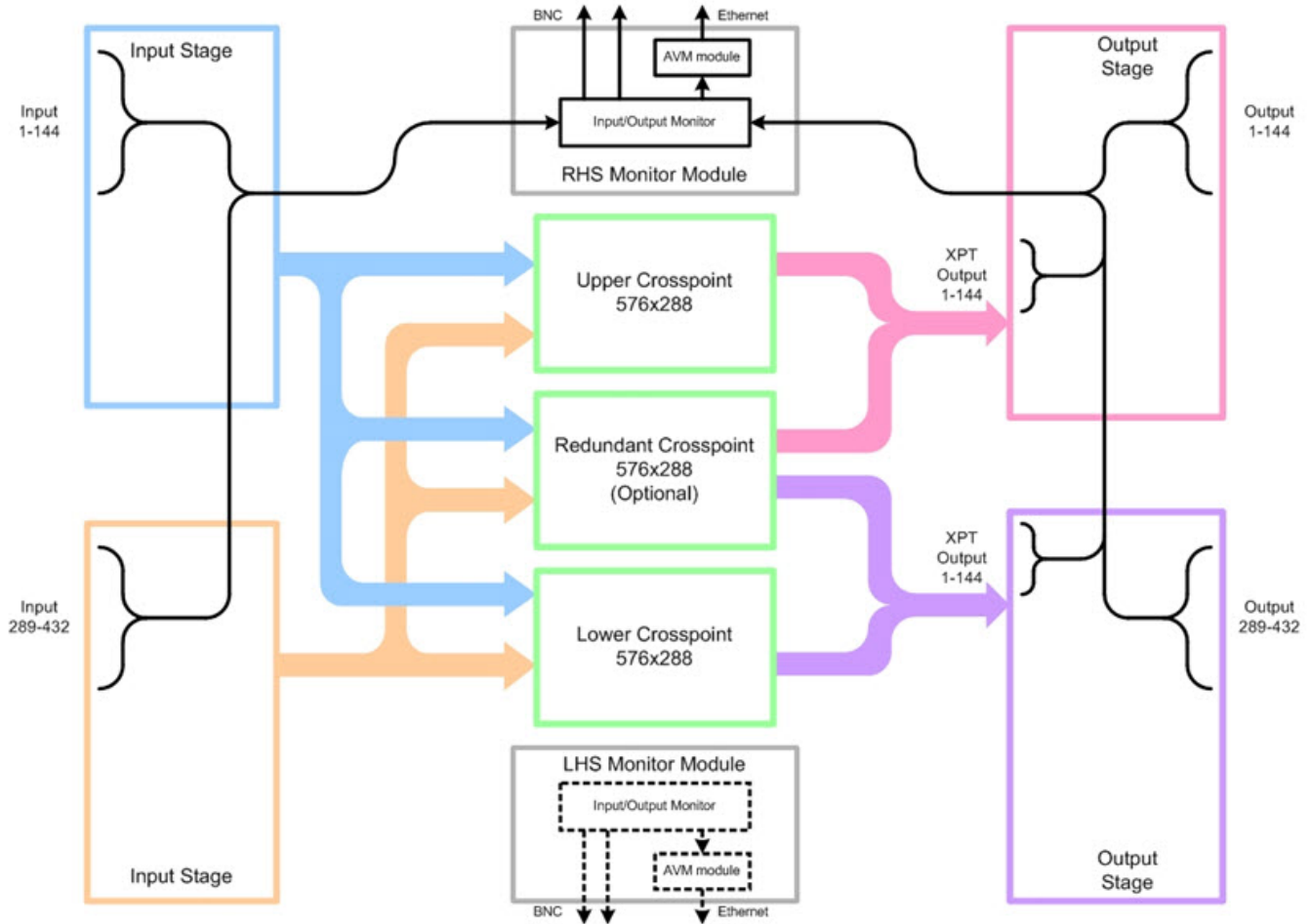

Figure 7-12 : EQX Signal Monitoring Path – Monitor 1 (RHS)

Monitor module 1 provides the ability to monitor the following signal points within the EQX router:

- **Video Inputs** 1 – 144
- **Video Inputs** 289 – 432
- **Upper Crosspoint Outputs** 1 – 144
- **Lower Crosspoint Outputs** 1 – 144
- **Redundant Crosspoints** 1 – 144
- **Video Outputs** 1 – 144
- **Video Outputs** 289 – 432

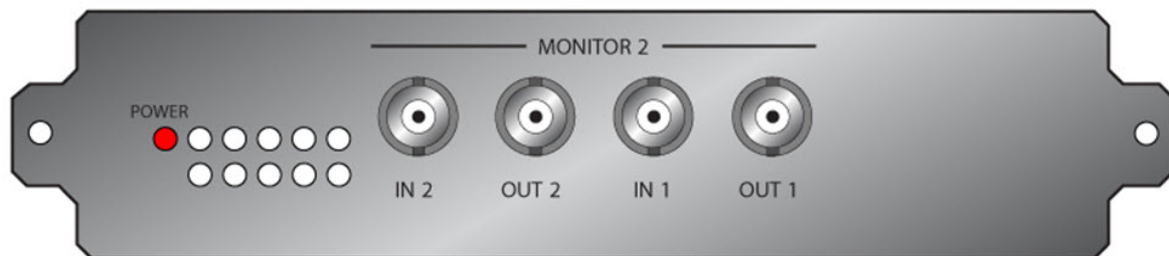

Figure 7-13 : Monitor 2 (Left Side of Frame)

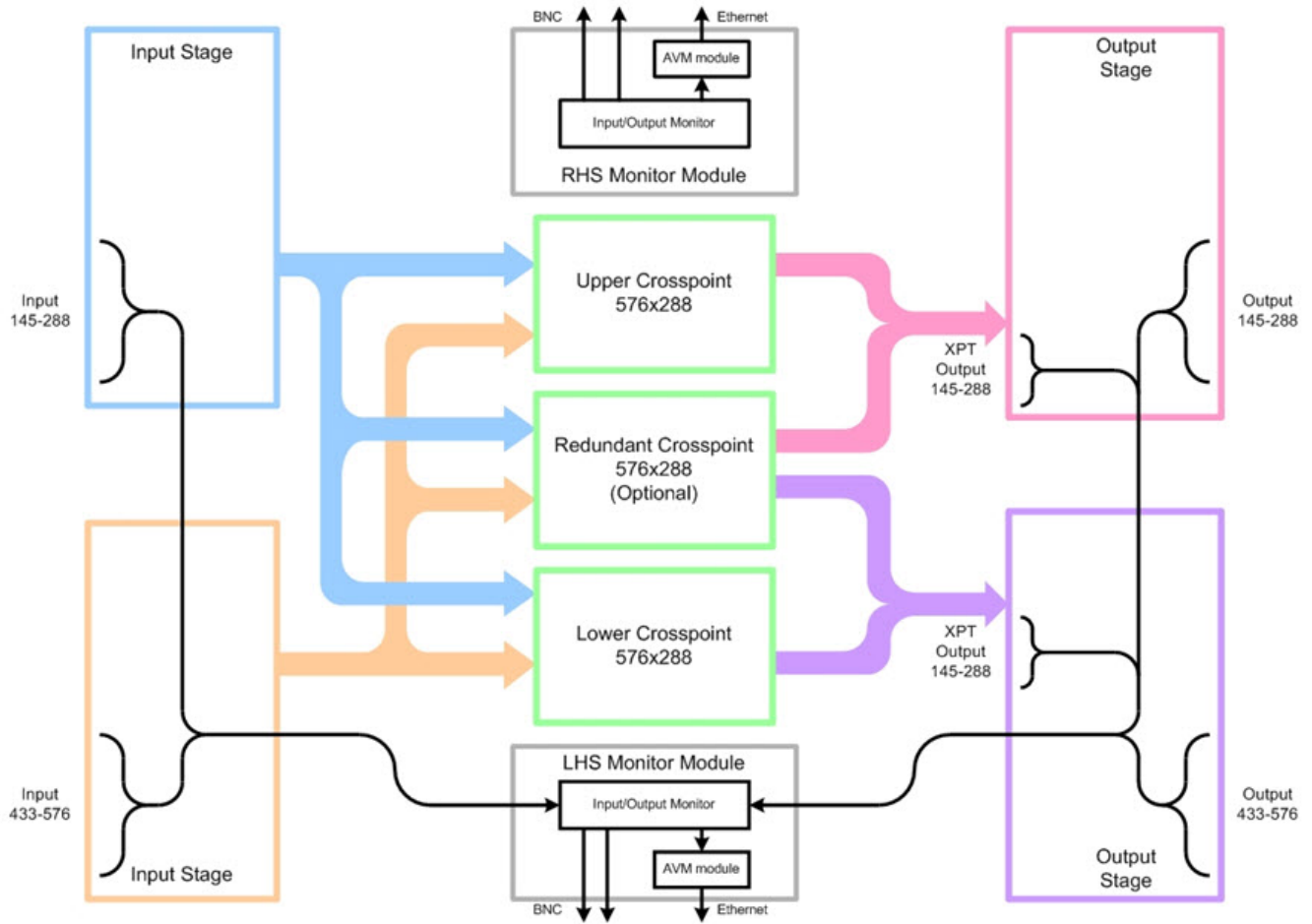

Figure 7-14 : EQX Signal Monitoring Path – Monitor 2 (LHS)

Monitor module 2 provides the ability to monitor the following signal points within the EQX router:

- **Video Inputs** 145 – 288
- **Video Inputs** 433 – 576
- **Upper Crosspoint Outputs** 145 – 288
- **Lower Crosspoint Outputs** 145 – 288
- **Redundant Crosspoints** 145 – 288
- **Video Outputs** 145 – 288
- **Video Outputs** 433 - 576

Each Monitor module provides two digital video input ports and two digital video output ports. Each of the digital output ports can be controlled independently and can be used to view different monitoring points within the EQX router, as long as the two ports are not trying to access the same Input or Output module.

In order to view any of the Sources and Destinations of the EQX router on Monitor outputs, loop “OUT 2” of Monitor 2 to “IN 2” of Monitor 1 and “OUT 2” of Monitor 1 to “IN 2” of Monitor 2. With this loop connection any source and destination can be viewed from Monitor 1 Output 1 and Monitor 2 Output 1

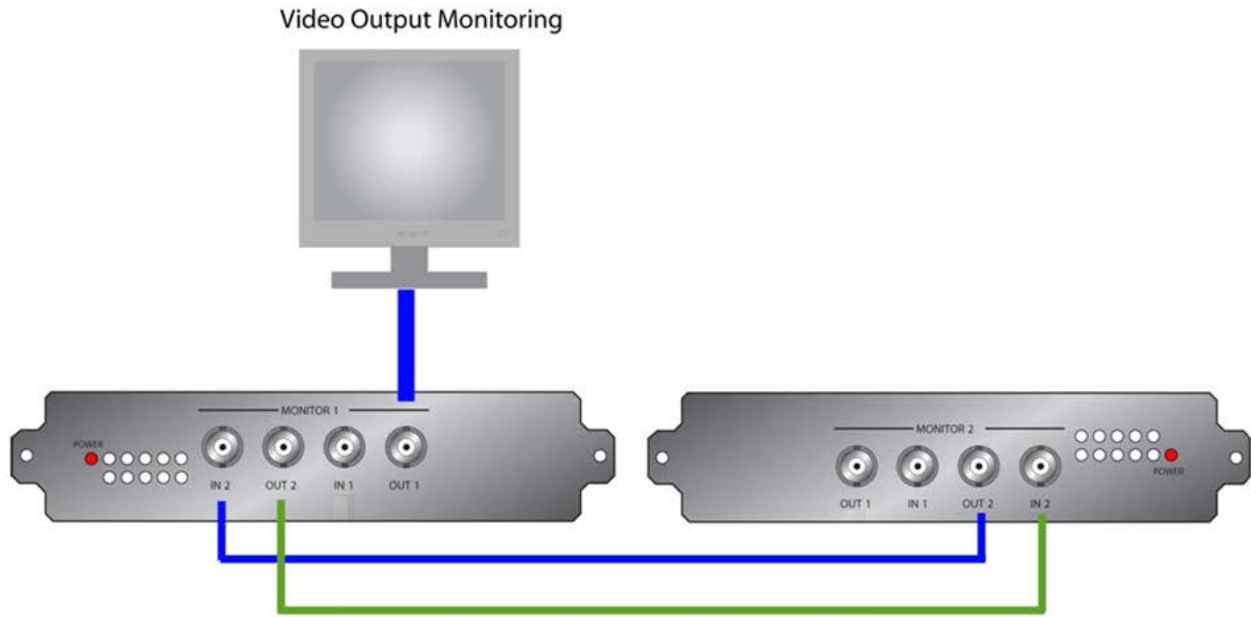

Figure 7-15 : Video Output Monitoring



Note: There are only two monitor ports for EQX10 which are directly coming from main XPT. There is no extra module required.

8 COOLING MODULES FOR 26 AND 16RU FRAMES

8.1 EQX INPUT & OUTPUT MODULE COOLING

The EQX frame is fan-assisted and air-cooled. The input and output modules that are located in the upper and lower section of the EQX frame are independently cooled. Both the upper and lower section of the frame is equipped with a single row of five fans. These fans draw cool air in through the front door of the frame and expel the hot air out of the rear of the frame.

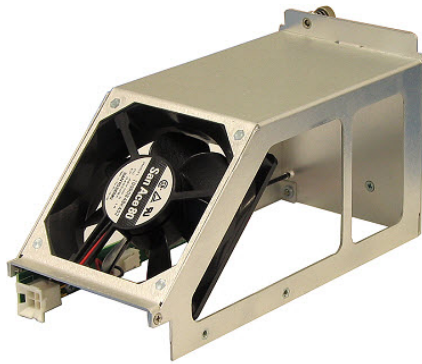

Each fan module is held in place by a single thumb screw and can be quickly and simply extracted and replaced from the front of the EQX frame should any one of them fail.

The single row of five fans that are located in both the upper and lower sections of the EQX frame are arranged in a n+1 configuration and provide redundancy, allowing a single fan to fail in either or both of the rows without causing the I/O modules to overheat. The performance of the fans is constantly monitored by the frame controllers. Any faults or failures are immediately reported.

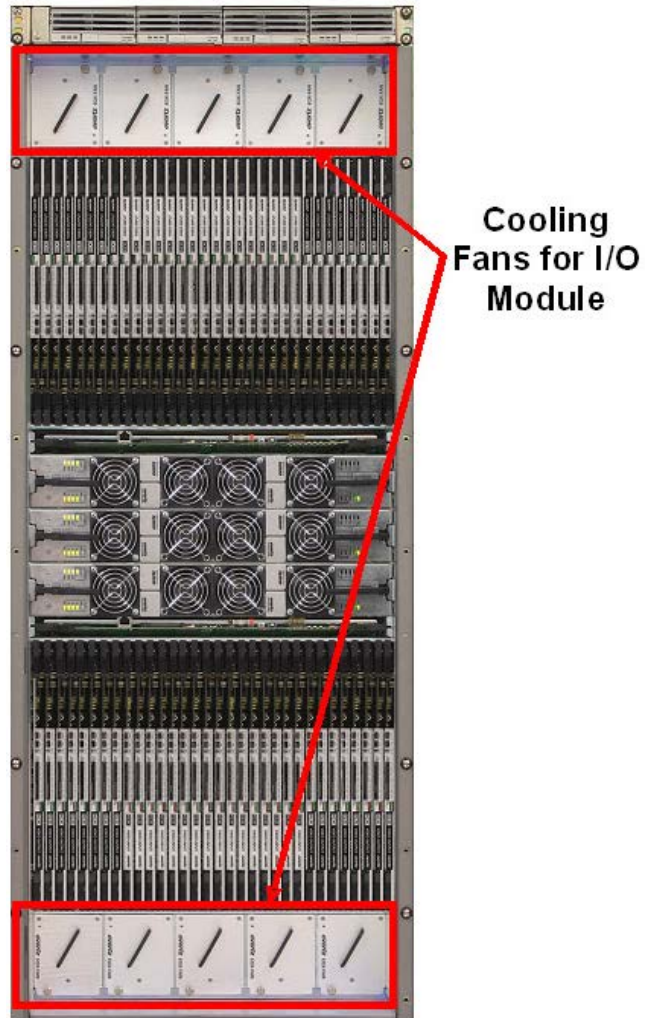

Note: Make sure the door vents are always open and nothing restricts the air flow.

There are four different types of cooling modules that are being used:

EQX-FAN: These cooling modules were used in the frames with first generation I/O modules.

2 Wire EQX-FAN-HF: These modules are called “High Flow” cooling modules and have higher air flow compare to EQX-FAN. They are used in the frames with AVIP, AVOP and XIO modules. Since they are two wired, they do not support auto speed control.

4 Wire EQX-FAN-HF: These cooling modules are similar to 2 wire HF fans and are used in the newer frames with AVIP, AVOP and XIO modules. They are four wired modules and have support for auto speed control.

EQX-FAN-QT: These modules are called “Quiet” Cooling modules because they are a lot quieter compare to the other modules. There are two cooling fans inside each module for better air flow; these modules can’t be installed in a regular frame. There is a special frame which has opening on the top and bottom of the frame for hot air expulsion. Contact factory for details.



Note: Never mix different cooling modules in a frame. Always install the same fan type in a frame



Note: EQX-FAN-QT can't be installed in a regular frame, it requires a special frame. Contact factory for compatibility.



Figure 8-1 : EQX-FAN-HF



Figure 8-2 : EQX-FAN-QT

The air-flow through the EQX is from front to rear. The cool air enters the frame at the front, passes over the input and output modules and then exits through the rear of the frame.

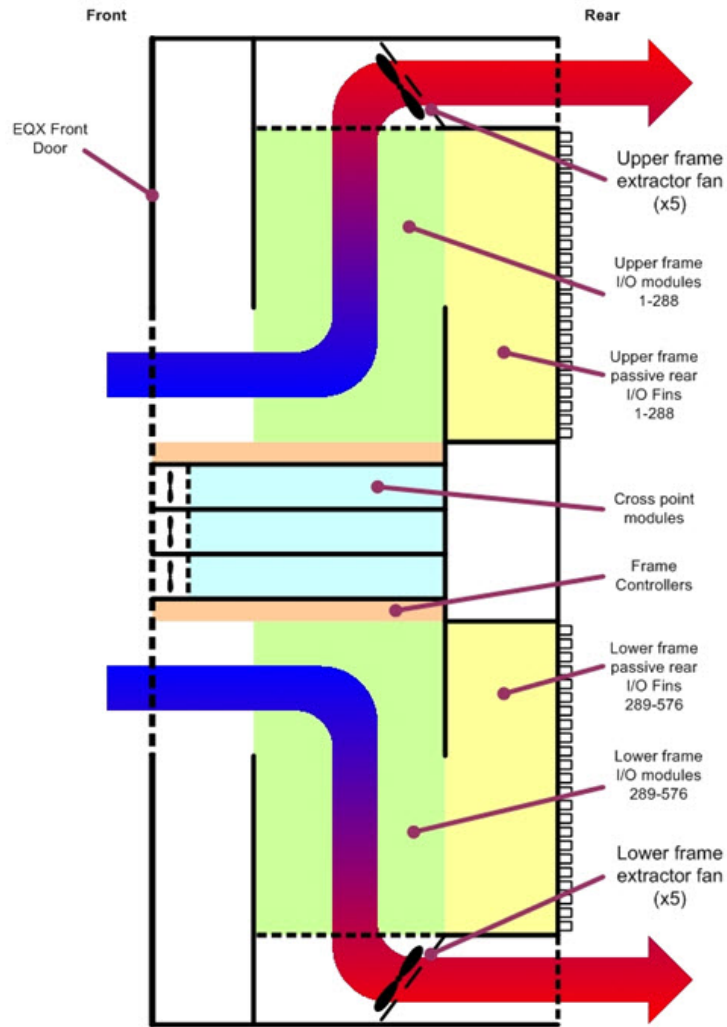

Figure 8-3 : EQX Frame Air Flow with HF Cooling Modules

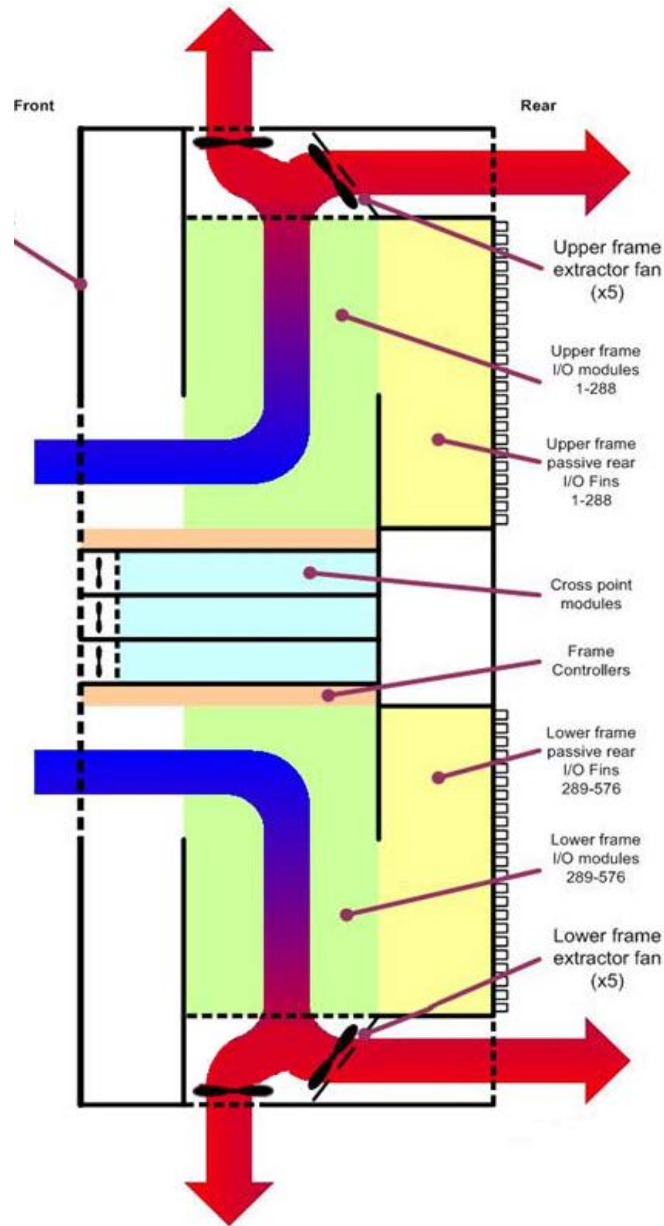

Figure 8-4 : EQX Frame Air Flow with QT Cooling Modules

8.1.1 I/O Fan Modules - Key Features

- Five fans are installed into the upper & lower sections of the frame providing independent cooling of the Input and Output modules.
- Front access to all of the fan modules.
- Individual fan assemblies can be hot-swapped.
- Redundant configuration ensures continuous cooling should a fan fail.

The EQX I/O fans should be inspected every six months to ensure they are functioning correctly and the thumb screws are tight. There are no fan filters to change.

8.2 EQX CROSSPOINT FAN MODULES

Each of the crosspoint modules within the EQX frame are independently cooled by a row of four fan modules mounted onto the front of the crosspoint assembly.

The crosspoint fans are arranged in an n+1 configuration providing redundancy, which ensures sufficient cooling should a fan fail at any time. The performances of all of the crosspoint fans are constantly monitored by the frame controller. Any faults or failures are immediately reported.



Each of the crosspoint fan modules can be simply and quickly removed and replaced while the crosspoint module is still in place and operational.

Cool air is drawn into the front of the crosspoint module, passed over the crosspoint circuitry and expelled out of the side of the frame.

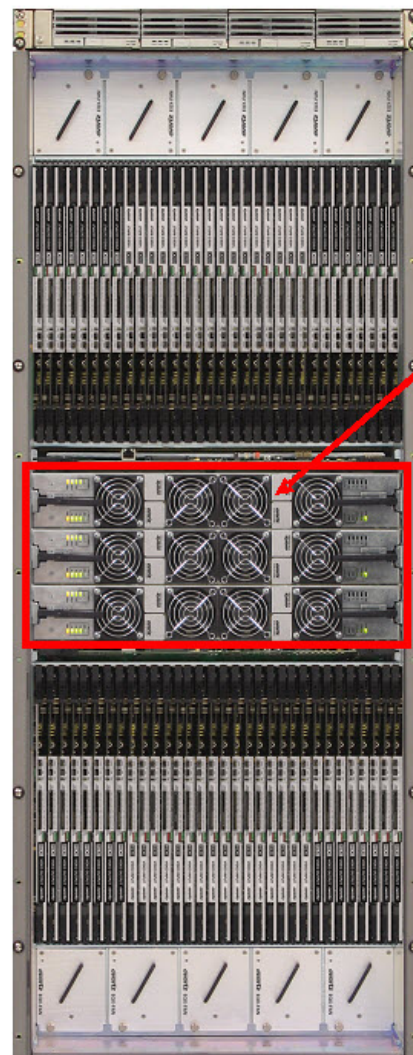

Cooling Fans for Module

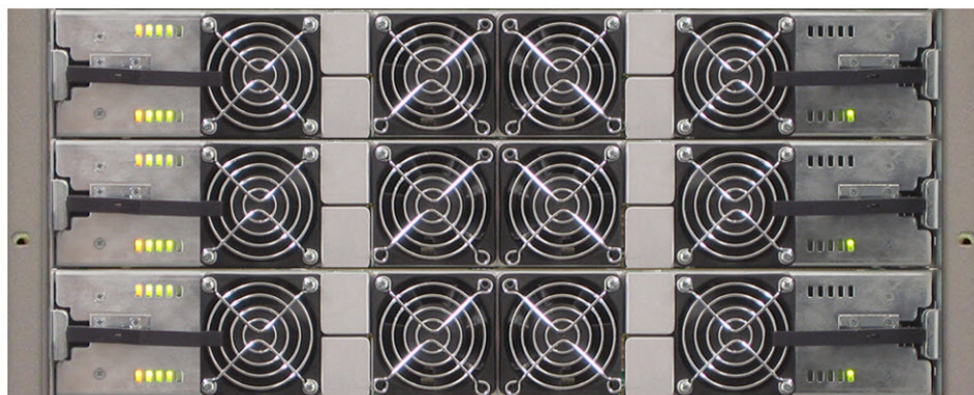

Figure 8-5 : Cooling Fans for Module



Figure 8-6 : EQX-XPT-576X576 Cooling Fan



Figure 8-7 : EQX-XPTG-576X576 Cooling Fan

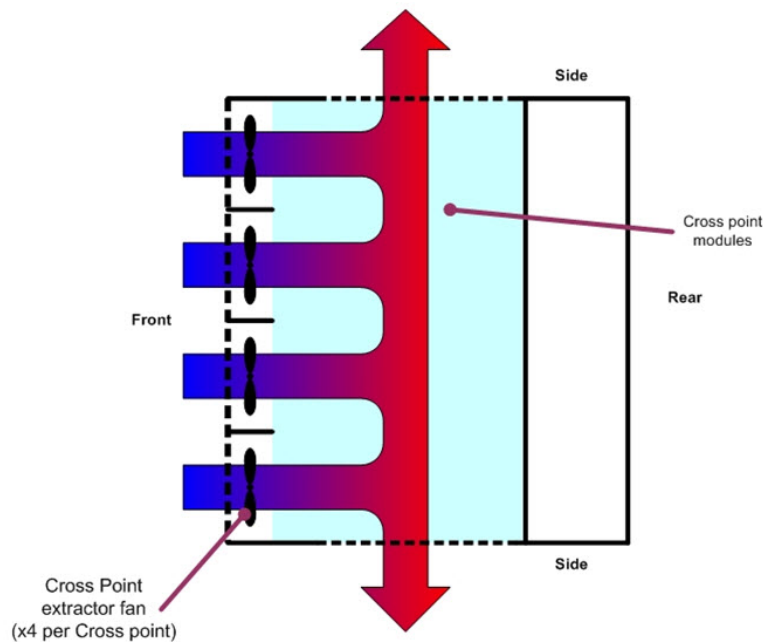

Figure 8-8 : EQX Crosspoint Module Air Flow – Top View

8.2.1 Crosspoint Fan Modules - Key Features

- Each crosspoint assembly is independently cooled.
- N+1 configuration ensures continuous cooling should a fan fail.
- Individual fan assemblies can be hot-swapped.

The EQX crosspoint fans should be visually inspected every six months to ensure they are functioning correctly and the thumb screws are tight. There are no fan filters to change.

9 COOLING MODULES FOR EQX10 FRAME

9.1 EQX10 INPUT AND OUTPUT COOLING MODULES

The EQX10 frame is fan-assisted and air-cooled. The input and output modules that are located in the left and right section of the EQX frame, are independently cooled. The upper section of the frame is equipped with four fan modules. These fans draw cool air in through the front door of the frame and expel the hot air out of the rear and top of the frame.

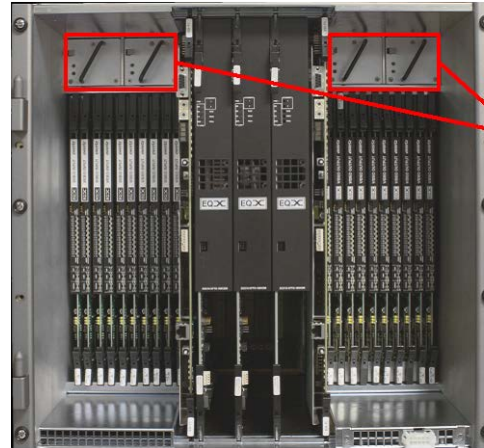

Cooling Fans for I/O Modules



9.1.1 EQX10 Cooling module

Each fan module is held in place by a single thumb latch and can be quickly and simply extracted and replaced from the front of the EQX frame should any one of them fail. The performance of the fans is constantly monitored by the frame controllers. Any faults or failures are immediately reported.

There is only QT type of cooling modules being used for EQX10.

EQX10-FAN-QT: These modules are called “Quiet” Cooling modules because they are a lot quieter and have two cooling fans for better air flow;



Figure 9-1 : EQX10-FAN-QT

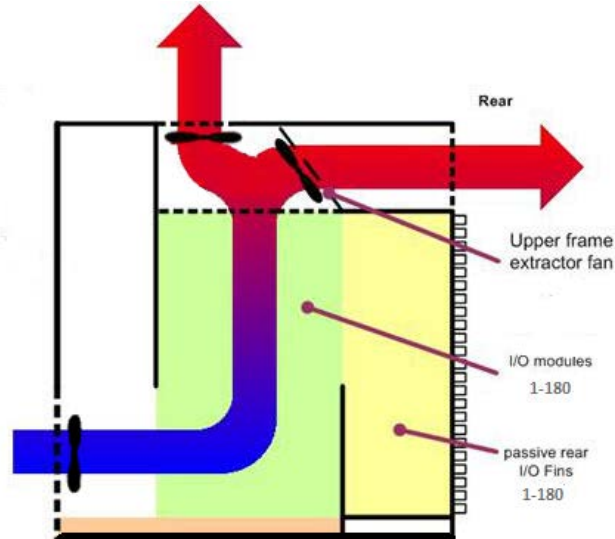

Figure 9-2 : EQX10 Frame Air Flow

9.1.2 I/O Fan Modules - Key Features

- Four fans are installed in the upper sections of the frame providing independent cooling of the Input and Output modules.
- Front access to all of the fan modules.
- Individual fan assemblies can be hot-swapped.

The EQX I/O fans should be inspected every six months to ensure they are functioning correctly and they are secured in their place. There are no fan filters to change.

9.2 EQX CROSSPOINT FAN MODULES

Each of the crosspoint modules in the EQX10 frame is independently cooled by a single fan module mounted behind the front air-dam.

10 CONFIGURING EQX USING WINSETUP

The WinSetup program is used to configure the routing functions, including control panel operation. It configures such parameters as the number of signal levels to be defined, which routing frames and panels are connected to the system, and the names of the inputs and outputs.

WinSetup is supplied with a comprehensive help system that can be accessed by pressing **F1** (function key F1) from any screen (dialog). The help system can also be entered from the *Help, Index* menu. The following notes will guide you through the configuration of WinSetup.



Note: This WinSetup guide assumes the configuration of an EQX router with full redundancy, including a redundant crosspoint module. It also assumes that the EQX router is being operated as a single level video with embedded audio.

Press **F1** to enter the help menu at any time.

Figure 10-1 shows the main WinSetup screen. Any part of the system can be configured from the menu at the top of the screen, or alternatively the grey bars above each main section can be used for quick access to specific items.

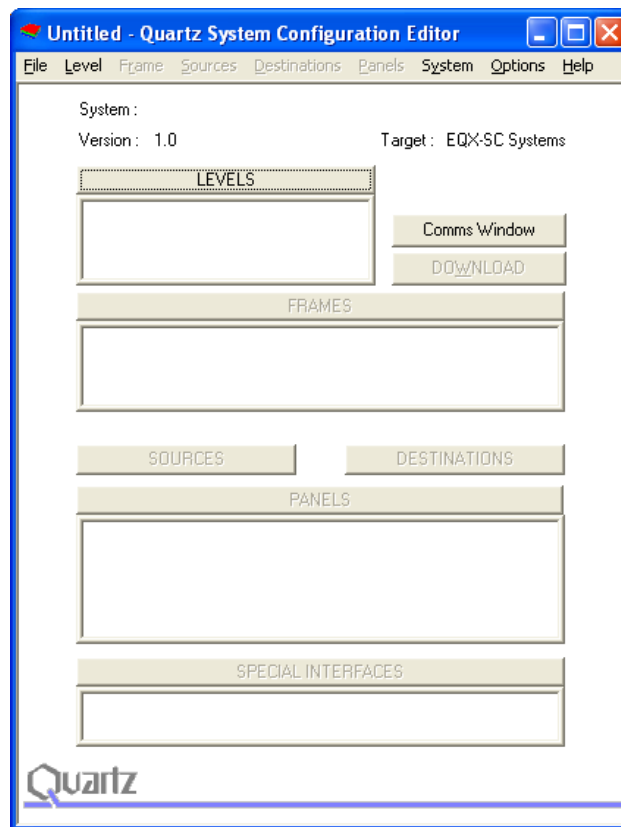

Figure 10-1 : Quartz System Configuration Editor Window

If you are generating a new system configuration, then some of the menus and functions will be grayed out (indicating that they are not available), as shown in Figure 10-1. This is deliberate in order to 'lead you through' the functions that need to be set up.

To configure the EQX router using WinSetup, carry out the following functions described in sections 10.1 through 10.11.

10.1 LEVELS

Traditionally, levels are used to define the makeup of a routing system such as video, audio and control data. Each signal type is normally allocated its own level. The EQX router also uses the level system to define the *Routing Level* and the *Redundant Level* in addition to the more traditional signal levels.

To set up the EQX router, enter the “Levels” menu by clicking the grey “Level” section heading. This action will automatically open the “System Levels” window, as shown in Figure 10-2.

The EQX router requires that two (2) Levels are created within this menu if the back-up crosspoint is fitted:

- **Level 1** is used for the main video routes.
- **Level 2** is used for the redundant video routes. (Only required if the optional redundant crosspoint is fitted.)

To create a Level, click the Level to be set, in this example “Level 1”. A blue background will highlight the text to confirm the selection.

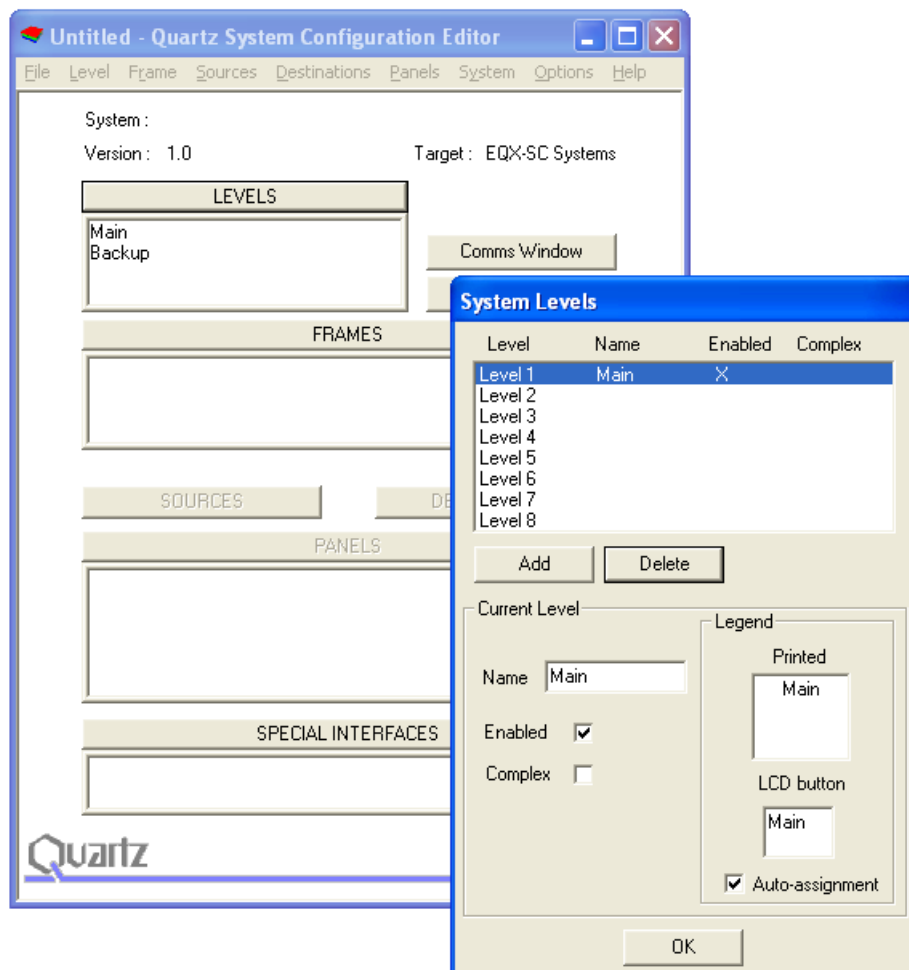
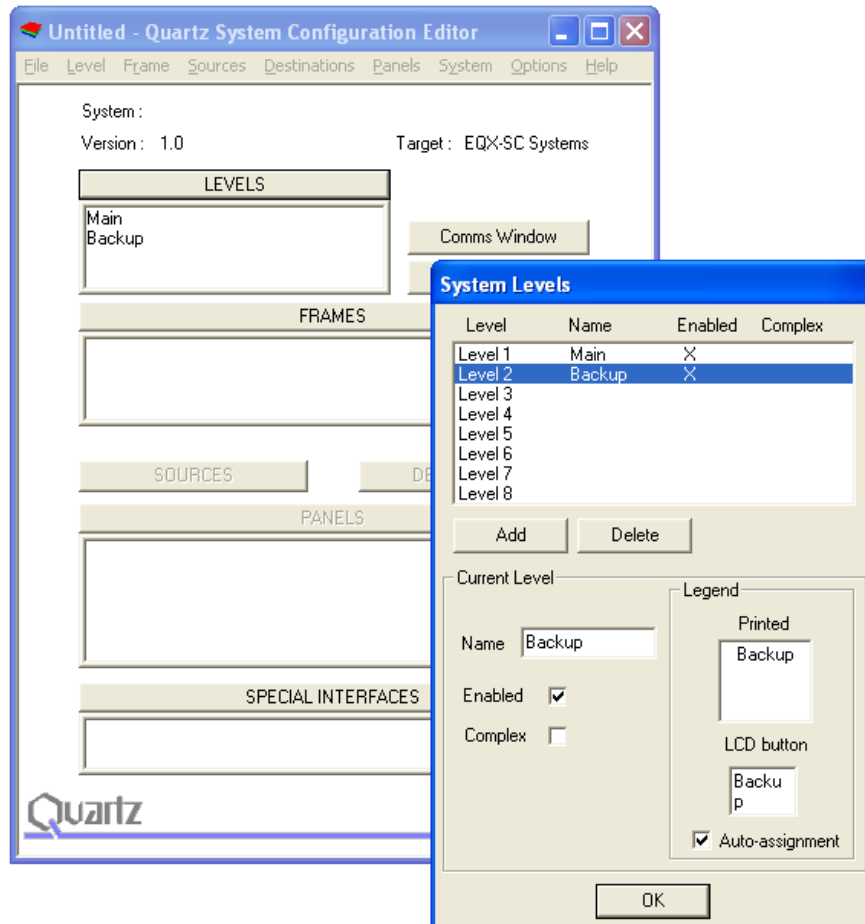

Figure 10-2 : Creating the “Main Video Route” Level

Enter the required level name into the “Name” field; in this example the name “Main” has been used. Select the *Add* button. This will add Level 1 to the system configuration with the label set to “Main”.

Create the second Level by clicking “Level 2”. Once again, a blue background will highlight the text to confirm the selection, as shown in Figure 10-3.



(Only required if the optional redundant crosspoint is fitted)

Figure 10-3 : Creating the “Backup Video Route” Level

Enter the required level name into the “Name” field; in this example the name “Backup” has been used. Select the *Add* button. This will add Level 2 to the system configuration with the label set to “Backup”. Then select “OK” to close the window.



Note: Do not check off the “Complex” box.

10.2 FRAMES

Next, enter the “Frames” menu by clicking on the grey “Frames” section heading. This automatically opens up the “System Frames” window as shown in Figure 10-4. From here click the “New” button. This will automatically open the “Frame Type” window.

The “Frame Type” window will display all the different EQX routers sizes. Select the part number that matches the hardware by clicking the corresponding line. The part number shown on the frame does not always represent a fully loaded router. Use the part number that correctly represents the router frame.

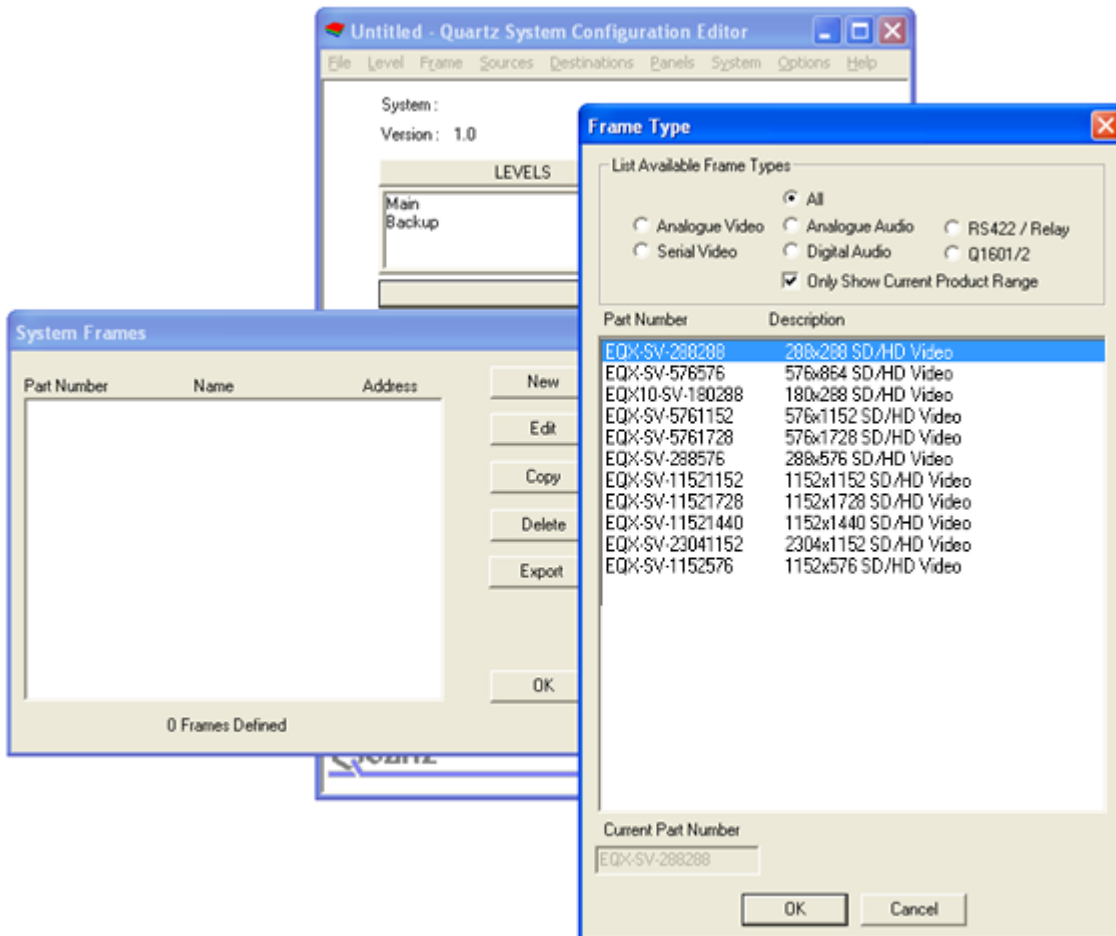

Figure 10-4 : Selecting the Frame Type

A blue background will highlight the text to confirm the selection. There are two types of EQX router frames to choose from:

1. **EQX-SV-576XXX:** This is the 26RU model
2. **EQX-SV-288XXX:** This is the 16RU model
3. **EQX10-SV180288:** This is the 10RU model

Click the “OK” button to confirm the frame selection. This automatically opens up the “New Frame” window.

The “*New Frame*” window allows the physical and control parameters of the inputs and outputs of the EQX router to be configured in more detail.



Note: The “*New Frame*” can also be labelled “*Edit Frame*” window. The functionality of both these windows is the same and the name changes when the window is re-entered from the “*Frame*” menu.



Note: The description and graphics shown here assume the configuration of the 26RUEQX router with redundant crosspoint module fitted.

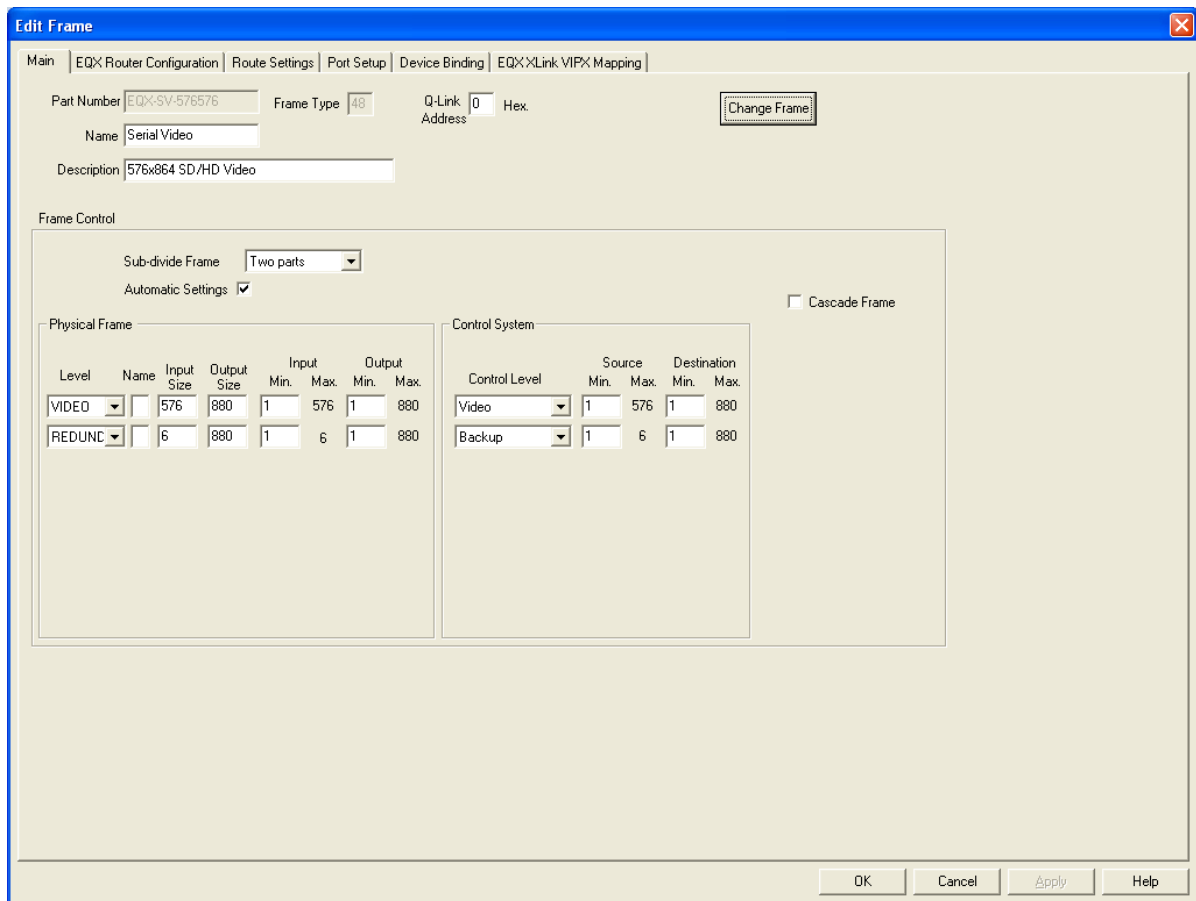

Figure 10-5 : New Frame Window – Default setting when first opened

When the “*New Frame*” window is opened for the first time after selecting the EQX router, a default graphical view will be seen, as shown in Figure 10-5.

The part number for the selected frame along with its Frame Type number is shown (grayed out) for confirmation. If the wrong frame type has been selected, then it can be changed by clicking on the “*Change Frame*” button.

The EQX frame is automatically given a Q-Link address; the default value is “0” and has to remain “0”



Note: The physical Q-Link address on the top EQX Frame Controller must be set to “0” and Q-Link address on the bottom EQX Frame Controller must be set to “1”.

The “Name” field is automatically picked up from the “Frame Type” window. It can be changed at any time by entering a new name directly into this field.

The “Description” field is also automatically picked up from the “Frame Type” window and will show a fully configured frame. It can be changed at any time to match the size of a sub-loaded frame by entering a new description directly into this field.

The next step is to Sub-divide the EQX frame into two (2) parts if it is not done automatically. This is required for the configuration of the redundant crosspoint.

Click on the “Sub-divide Frame” drop down list and select “Two parts”. This will change the window display as shown in Figure 10-6.

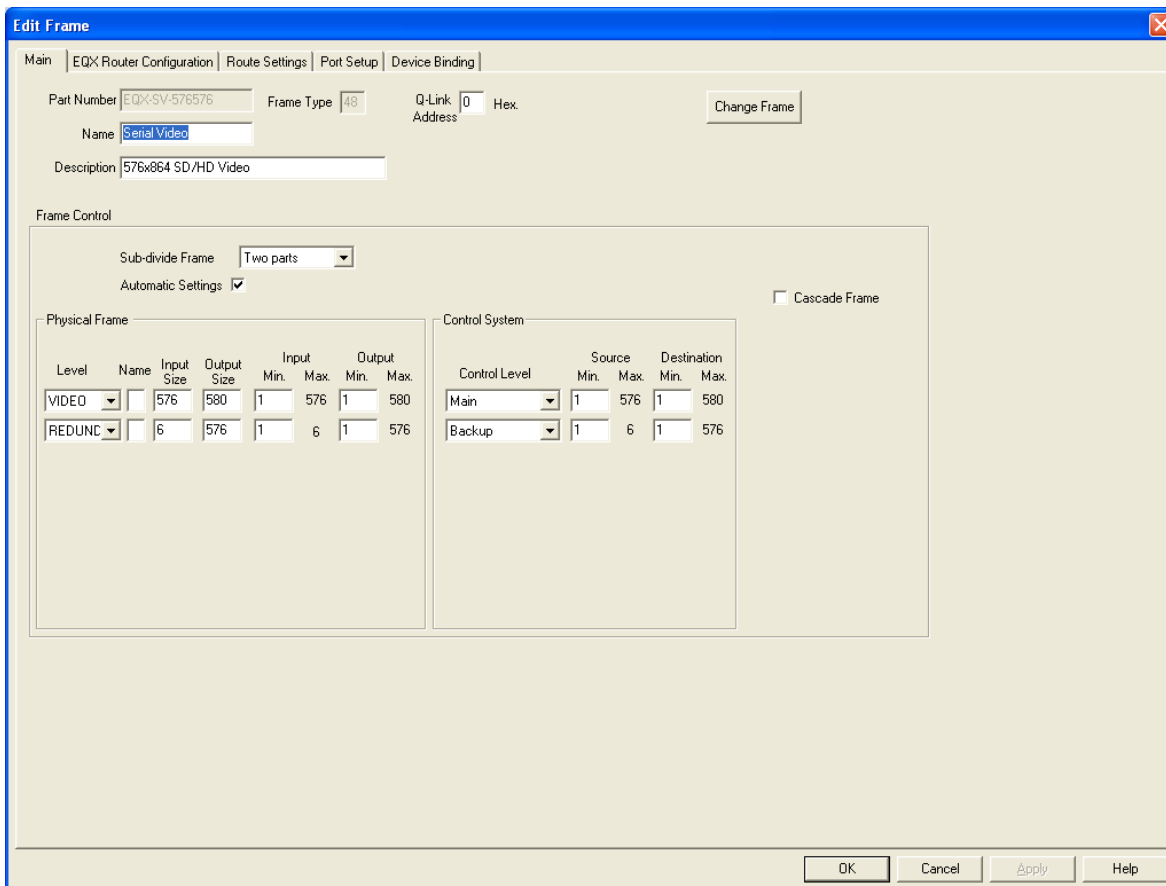

The screenshot shows the 'Edit Frame' window with the following configuration:

- Part Number: EQX-SV-576576
- Frame Type: 48
- Q-Link Address: 0 Hex.
- Name: Serial Video
- Description: 576x864 SD/HD Video
- Sub-divide Frame: Two parts
- Automatic Settings:
- Cascade Frame:

The 'Physical Frame' section contains two tables:

Level	Name	Input Size	Output Size	Input Min.	Input Max.	Output Min.	Output Max.
VIDEO		576	580	1	576	1	580
REDUNC		6	576	1	6	1	576

Control Level	Source Min.	Source Max.	Destination Min.	Destination Max.
Main	1	576	1	580
Backup	1	6	1	576

Figure 10-6 : New Frame Window – Set for “Two parts”

In the “Physical Frame” area of the window, use the “Level” drop down menus to select each one of the two levels, shown in Figure 10-6 by the “Video” and “Redundant” headings.

The two levels shown in the “Control System” area of this window will automatically default to the two control levels created earlier, “Route” and “REDNT”. If not, use the relevant drop down menus and select the correct control level.



Note: The numbers that appear in the boxes to the right of the “*Physical Frame*” and “*Control System*” areas are loaded by the WinSetup software as default values based on an equal split of the frame. When configuring the EQX router with a redundant crosspoint configuration these values must be changed. See section 10.3.

Once the two levels have been set, then the next stage is to correctly enter the input and output matrix size as shown in Figure 10-7, assumes an EQX26 frame fully populated with 576x576 I/O's.

Level	Name	Input Size	Output Size	Input Min.	Input Max.	Output Min.	Output Max.
VIDEO		576	580	1	576	1	580
REDUNC		6	576	1	6	1	576

Control Level	Source Min.	Source Max.	Destination Min.	Destination Max.
Main	1	576	1	580
Backup	1	6	1	576

Figure 10-7 : New Frame Window – Enter the Required Input and Output Values

Enter the following values for the “*Physical Frame*”.

To configure the “*Video Level*” enter these values:

- “*Input Size*” set to 576.
- “*Output Size*” set to 580. The four additional outputs will be used for monitoring outputs.
- “*Input Min*” set to 1.
- “*Output Min*” set to 1.

The “*Control System*” will pick up these new values automatically.

The Redundant level is used to control the crosspoint redundancy. The six inputs assigned to this level are virtual inputs, and allow control to be made on a per-destination basis.

To configure the “Redundant Level”, enter these values:

- “Input Size” set to 6.
- “Output Size” set to 576.
- “Input Min” set to 1.
- “Output Min” set to 1.

The “Control System” will pick up these new values automatically.

10.3 EQX ROUTER CONFIGURATION

To set up the EQX, click on the “EQX Router Configuration” tab. This will provide access to the EQX configuration options, as shown in Figure 10-8. This view is used to set up the EQX Hardware as well as the Source Parameters.

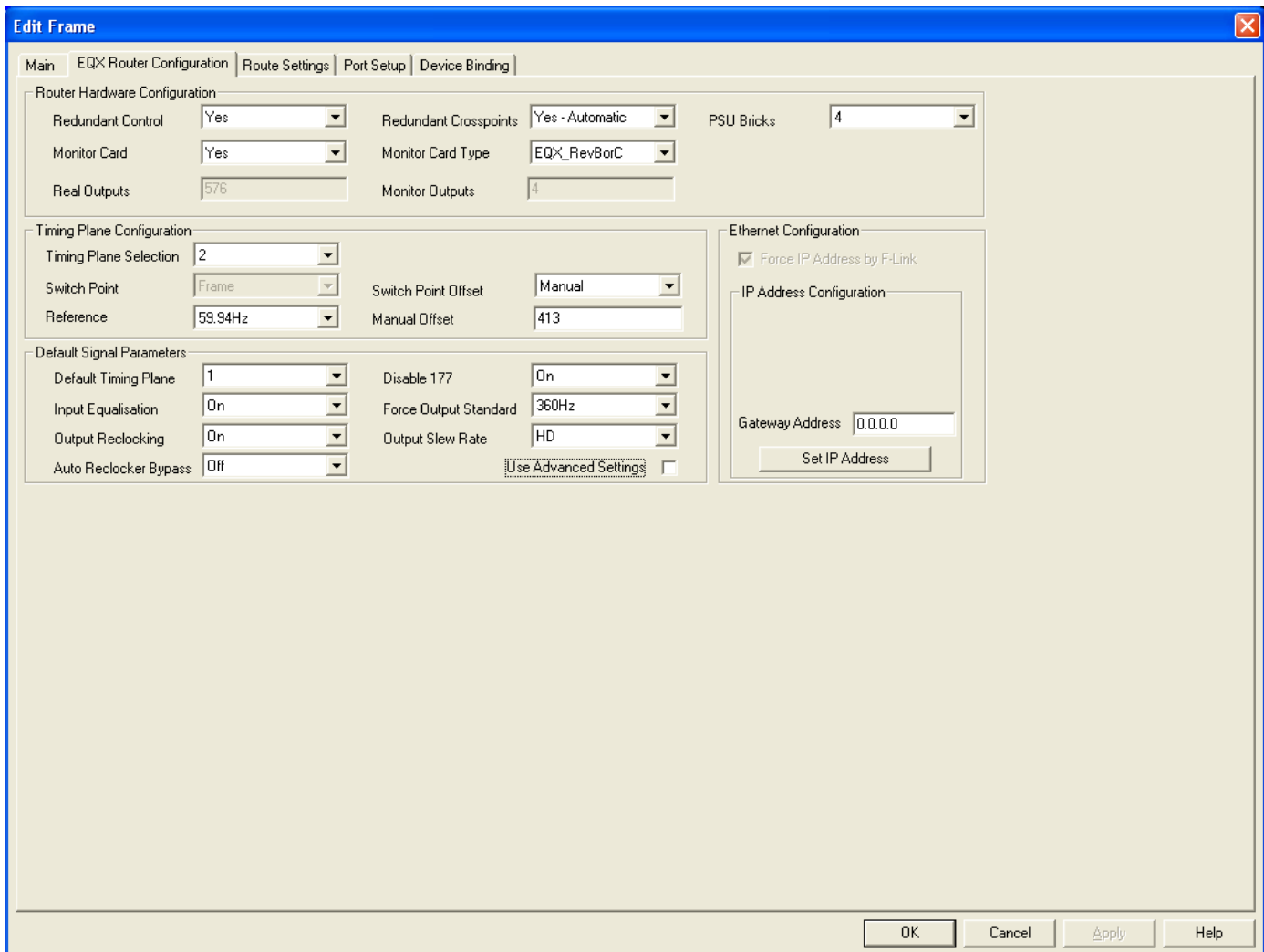

The screenshot shows the "Edit Frame" window with the "EQX Router Configuration" tab selected. The window is divided into several sections:

- Router Hardware Configuration:**
 - Redundant Control: Yes
 - Redundant Crosspoints: Yes - Automatic
 - PSU Bricks: 4
 - Monitor Card: Yes
 - Monitor Card Type: EQX_RevBorC
 - Real Outputs: 576
 - Monitor Outputs: 4
- Timing Plane Configuration:**
 - Timing Plane Selection: 2
 - Switch Point: Frame
 - Switch Point Offset: Manual
 - Reference: 59.94Hz
 - Manual Offset: 413
- Default Signal Parameters:**
 - Default Timing Plane: 1
 - Disable 177: On
 - Input Equalisation: On
 - Force Output Standard: 360Hz
 - Output Reclocking: On
 - Output Slew Rate: HD
 - Auto Reclocker Bypass: Off
 - Use Advanced Settings:
- Ethernet Configuration:**
 - Force IP Address by F-Link:
 - IP Address Configuration: (Empty field)
 - Gateway Address: 0.0.0.0
 - Set IP Address button

At the bottom of the window are buttons for OK, Cancel, Apply, and Help.

Figure 10-8 : EQX Configuration Window (WinSetup version 4.XX)

When opened for the first time this screen will show a default configuration. Use the various drop-down menus to change each or the EQX parameters as required.

The EQX router configuration window is divided into five distinct areas, which are:

- a. Router Hardware Configuration
- b. Timing Plane Configuration
- c. Default Signal Parameters
- d. Advanced Signal parameters
- e. Ethernet configuration

10.3.1 Router Hardware Configuration

This section is used to select the hardware options that have been purchased as part of the EQX router. The options are as follows:

Redundant Controller: **Yes**, this confirms that the redundant (second) frame controller module is fitted to the EQX frame.

No, this confirms that only one frame controller module is fitted to the EQX frame.

Redundant Crosspoint: **No**, this confirms that the redundant crosspoint module is NOT fitted to the EQX frame.

Yes – Manual, this confirms that the redundant crosspoint module is fitted to the EQX frame and that it has been set into manual switch over mode, regardless of the setting made on the redundancy level.

Yes – Automatic, this confirms that the redundant crosspoint module is fitted to the EQX frame and that it has been set into automatic switch over mode. Note that automatic switchover only happens from a main crosspoint to the redundant. The switch back to main crosspoint must always be made manually.

PSU Bricks: **1 through to 8**, select the number of power supply modules that are fitted into the external EQX power supply frame.



A typical fully populated 576x576 EQX router requires four (4) power supply modules for non-redundant operation and eight (8) for fully redundant operation.

A fully populated 288x288 EQX router requires two (2) power supply modules for non-redundant operation and four (4) for fully redundant operation.

Monitor module: **No**, this confirms that the monitor module is not fitted to the EQX Router.

Yes, this confirms that the monitor module is fitted to the EQX Router.

Monitor module Type: **EQX_RevBorC**, this confirms that the monitor modules are RevC with 2 monitoring outputs

EQX_4MON, this confirms that EQX frame is equipped with special monitor modules which have four monitoring outputs

10.3.2 Timing Plane Configuration

In order for a router to provide a clean SMPTE compliant switch the video sources must be synchronous (correctly timed) with respect to the reference. The crosspoint must also be switched at the correct point within the video signal. However, the switch point for each type of video signal format (for example SD 625, HD 720p and HD 1080i) is different. This means that today's routers must be able to internally generate a number of different timing planes in order to correctly switch multiple video formats. The EQX is able to generate up to four independent timing planes each of which are defined by the values and settings that are selected in the "Timing Plane Configuration" window.

The video reference connected for the EQX can be a Bi-level or Tri-level signal, as the EQX will generate the correct timings for SD and HD video signals from either. A 50Hz or 59.94Hz reference must be used in order to generate 50Hz or 59.94Hz timings. If 50Hz and 59.94Hz video signals are to be switched through the EQX then both a 50Hz and 59.94Hz reference signal must be connected. The EQX has two reference input connectors to accommodate this requirement.

The timing plane configuration options are as follows:

Timing Plane: **1, 2, 3 or 4**, this selection determines which of the four (4) timing planes is being configured. Any changes to the other parameters within this area will only affect the timing plane that is currently selected.



Note: Each of the timing planes is independent and dedicated to a single video signal format, for example SD 625 @ 50Hz, or HD 720p @ 59.94Hz.

Reference: **50Hz**, this confirms that the selected timing plane is to use the 50Hz reference signal. This box will be greyed out as this selection is set automatically by the "Switch point Offset".

59.94Hz, this confirms that the selected timing plane is to use the 59.94Hz reference signal. This box will be greyed out as this selection is set automatically by the "Switch point Offset".



Note: The EQX router has two (2) Reference inputs. Both of the reference signals connected to these two inputs can be either bi-level or tri-level (or one of each). From the reference input(s), the EQX router is able to calculate the correct switch point for up to four independent timing planes. However, a 50Hz and/or 59.94Hz signal must be connected in order for the EQX to generate the correct switch point for a 50Hz and/or 59.94Hz signal.

Switch Point: **Frame**, this sets the switch point for the signal on the selected timing plane to be frame based. This box will be greyed out as this selection is set automatically by the "Switch point Offset".

Field, this sets the switch point for the signal on the selected timing plane to be field based. This box will be greyed out as this selection is set automatically by the "Switch point Offset".

Switch Point Offset: **Manual / 626 / 525 / 1080i 50Hz / 1080i 59.94Hz / 720p 50Hz or 720p 59.94Hz**, this sets the switch point offset for the signal on the selected timing plane. Selecting 'Manual' allows the switch point offset to be manually adjusted.

Manual Offset: Enter a numeric value that represents the required switch point offset for the selected timing plane. The value represents micro-seconds and can be used to compensate for system timing issues. This box is only available when the drop down list for 'Switch Point Offset' is set to **manual**.

10.3.3 Default Signal Parameters

This section is used to select the default settings for each timing plane for the additional features provided by the EQX router, such as Reclocking, ASI mode etc:

Default Timing Plane: **1, 2, 3 or 4**, this defines which timing plane is used as the default. Unless otherwise specified all the sources will use the parameters that are defined by the default timing plane.

Input Equalization: **ON**, this turns on the input equalization circuitry for each source.

Off, this turns off the input equalization circuitry for each source.

Output Reclocking: **ON**, this turns on the output reclocking circuitry for each source.

Off, this turns off the output reclocking circuitry for each source.

Auto Reclocker Bypass: **ON**, this turns on the auto reclocker bypass circuitry for each source. This setting will automatically bypass the output Reclockers if the Reclockers are unable to lock correctly to the signal.

Off, this turns off the auto reclocker bypass circuitry for each source.



Note: The auto reclocker bypass circuit will attempt to reclock the incoming signal, if it fails to reclock the signal, it will automatically switch the reclocker into bypass mode and bypass the reclocking circuit.

Disable 177 (ASI): **ON**, this turns on an optional mode within the EQX that prevents the Reclockers from incorrectly identifying the 270Mb/s ASI signal as a 177Mb/s signal.

Off, this turns off this mode.

Force Output Standard: **143 / 177 / 270 / 360 / 540 or 1485**, this forces the reclocker to lock to the signal format that is selected. It is recommended to be set to 270Mb/s when routing ASI signal.

Off, this turns this feature off – recommended default position when not routing ASI signals.



Note: If the reclocker is unable to lock the source to the selected format then an error message will be generated indicating that the wrong signal type has been switched to this destination. The signal will still pass through but will not be locked.

Output Slew Rate: *SD*, this sets the slew rate to the slower SD setting.

HD, this sets the slew rate to the faster HD setting.

Xpt Redundancy Output Priority: This identifies an output as having high priority. If contention for a redundant crosspoint route occurs, this priority is used to determine which output is routed. An output with higher priority will displace the incumbent output in this situation.

10.3.4 Advanced Signal Parameters

The advanced signal parameters are used to define the ‘Destination Parameters’ (exception rules) and are used to over-rule the Source Parameters when required. This is achieved by defining ‘Destination Parameters’. This may be necessary, for example, if the device that is directly fed from destination 576 requires the source to always be reclocked, then output 576 should be configured to reclock the source regardless of the parameters that have been defined by the source.

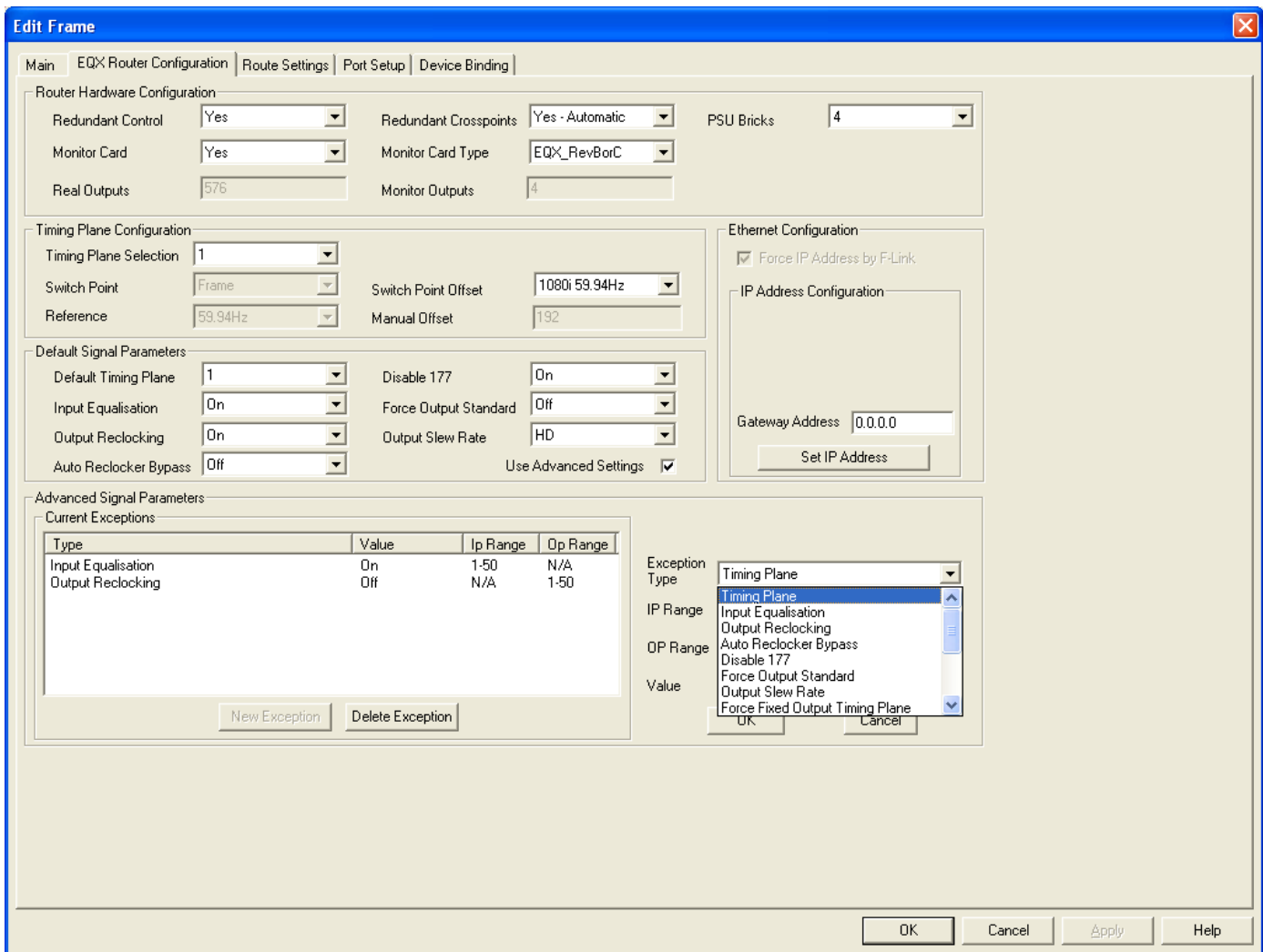

Figure 10-9 : EQX Configuration Window – Showing the Advanced Signal Parameters



Note: To gain access to the Advanced Signal Parameters check the box in the Default Timing Plane window called 'Use Advanced Settings'.

The primary role of the advanced settings is to allow the Source Parameters to be over-ruled by defining a new parameter for a single or range of destinations. However, the advanced setting also allows the Source Parameters to be re-defined on a temporary or permanent base. The change to a Source Parameter can be applied to a single source or range of Sources.

There are a number of exception types:

- **Timing Plane**
- **Input Equalization**
- **Output Reclocking**
- **Auto Reclocker Bypass**
- **Disable 177 (ASI)**
- **Force Output Standard**
- **Output Slew Rate**
- **Xpt Redundancy Output Priority**

The operational functionality of the features listed above are the same as described in section 10.3.2. The drop down menu labeled 'Values' is used in conjunction with the above features.

10.3.5 Creating an Exception Rule

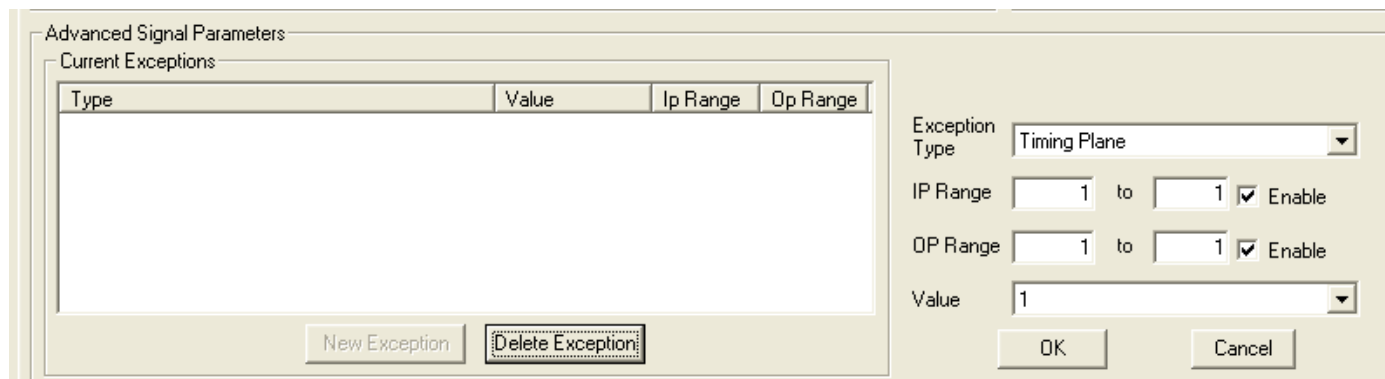

Figure 10-10 : Current Exceptions Window

- Step 1** – Click the “New Exception” button.
- Step 2** – Identify if the exception rule needs to be applied to the input and/or output of the EQX router. Enable the relevant section by clicking the “Enable” box. The Input Equalization rule can only be applied to an input.
- Step 3** – Set the range of inputs and/or outputs that the exception rule is to be applied to, for example 1 to 1 for a single I/O or 24 to 67 for multiple I/O’s.
- Step 4** – Select the “Exception type” from the drop down list.
- Step 5** – Select the “Value” from the drop down list.
- Step 6** – Click OK to return to the main menu screen.



Consider the following:

- If the exception rule is applied to a Source (input) then this change will be carried through to every Destination (output) that the Source is switched to.
- If the exception rule is applied to a Destination (output) then this change will only affect that Destination.

Example Exception Rules

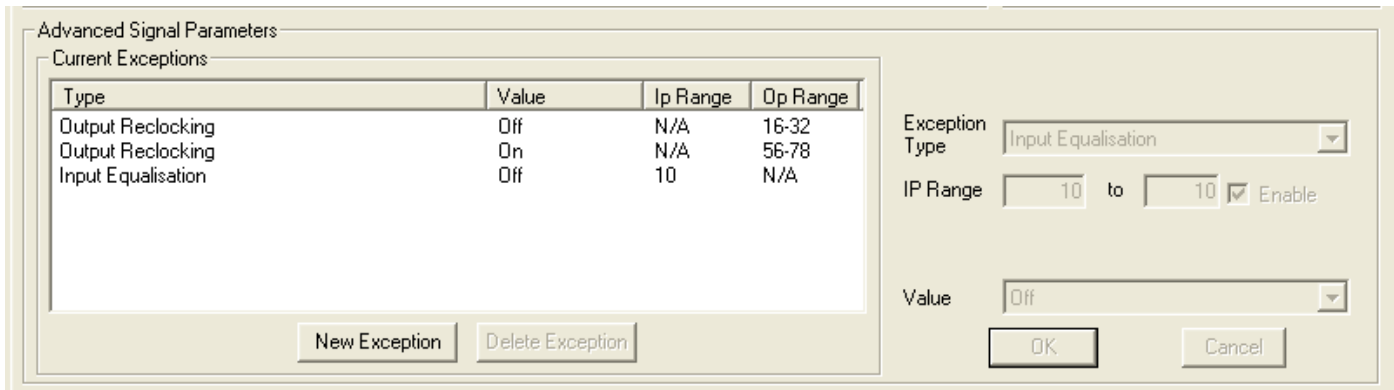

Advanced Signal Parameters

Current Exceptions

Type	Value	Ip Range	Op Range
Output Reclocking	Off	N/A	16-32
Output Reclocking	On	N/A	56-78
Input Equalisation	Off	10	N/A

Exception Type:

IP Range: to Enable

Value:

Figure 10-11 : Exception Rules

Figure 10-11 provides examples of three exceptions:

- The output reclockers are turned off for outputs 16 through to 32.
- The output reclockers are turned on for outputs 56 through to 78.
- The input equalization circuit is turned off for input 10.

10.3.6 Ethernet Configuration

Ethernet configuration is used to define the Gateway address and the IP addresses for all the modules in the frame. These IP addresses are pushed to the modules and change their IP addresses accordingly. The following steps will explain how to set the IP addresses.

Step1 -The first step is to define the gateway address as shown in Figure 10-12.

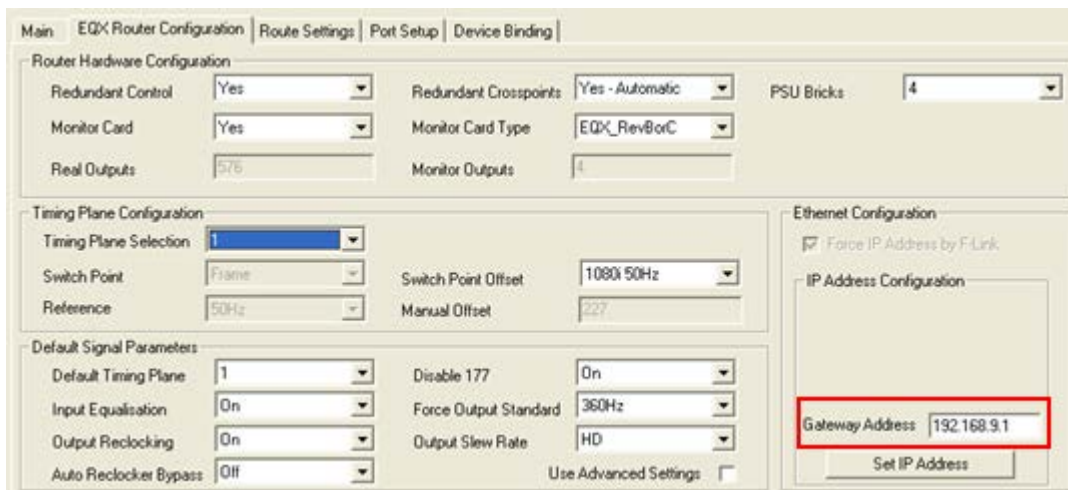

Figure 10-12 : Ethernet Configuration Step 1

Step2 -Click on the “Set IP Address” button, a new window “Set IP Address” will open

Step3 -For Frame set “1” and set “1” for “From” and set “74” for “To”

Step4 -Set the base IP address, this IP address will be the IP address of the first Output module.

Step5 -Click on ‘Set’ button, all the IP addresses will be set automatically

Step6 -Press the ‘OK’ button

Figure 10-13 shows the ‘Set IP Address’ windows.

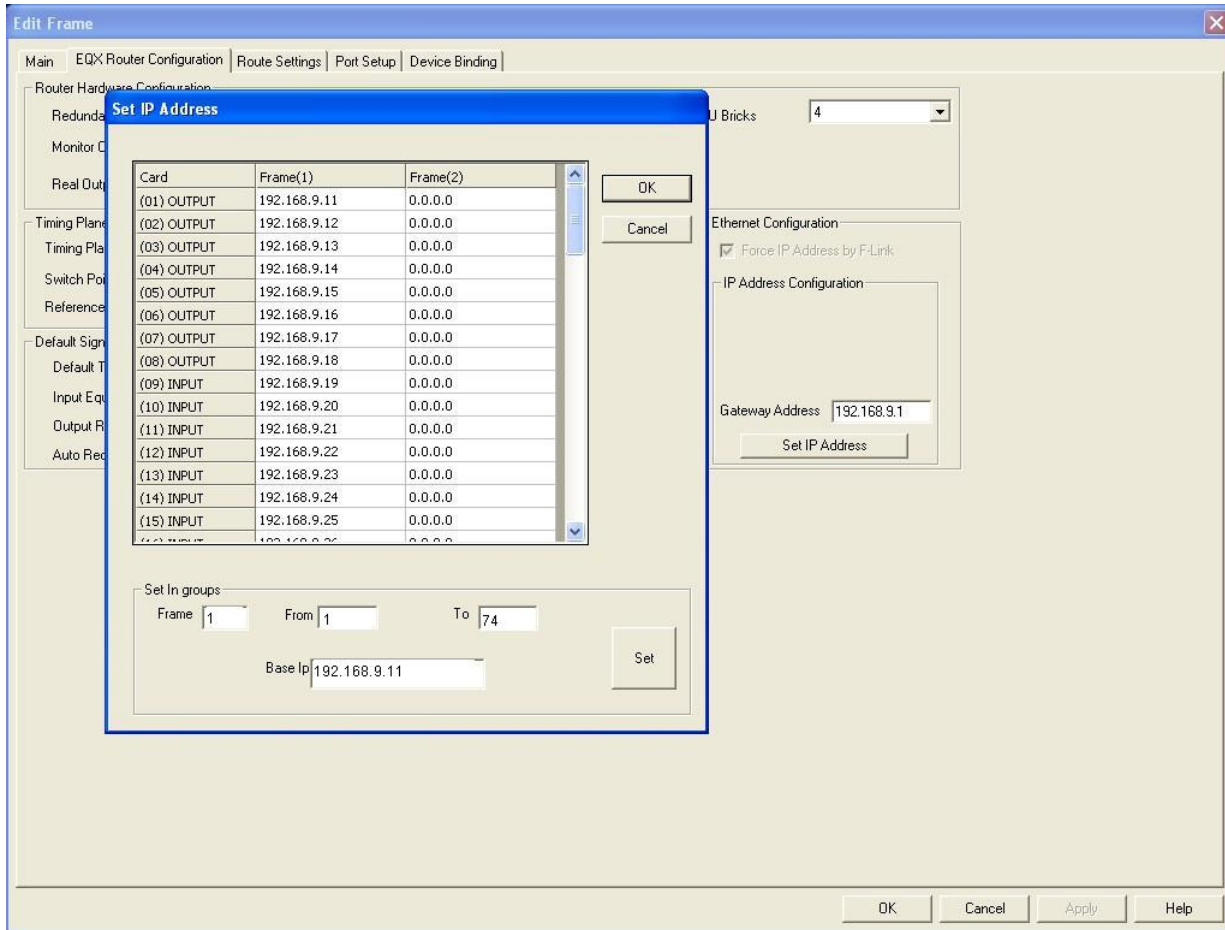

Figure 10-13 : Set IP Address Window

 **Note:** The IP addresses of the Frame Controllers have to be set manually, while the IP addresses of the other modules are set automatically based on the range specified in the WinSetup.

Slot	Module	Range	IP addresses
1	Output	1-18	192.168.9.11
2	Output	19-36	192.168.9.12
3	Output	37-54	192.168.9.13
4	Output	55-72	192.168.9.14
5	Output	73-90	192.168.9.15
6	Output	91-108	192.168.9.16
7	Output	109-126	192.168.9.17
8	Output	127-144	192.168.9.18
9	Input	18-Jan	192.168.9.19
10	Input	19-36	192.168.9.20
11	Input	37-54	192.168.9.21
12	Input	55-72	192.168.9.22
13	Input	73-90	192.168.9.23
14	Input	91-108	192.168.9.24
15	Input	109-126	192.168.9.25
16	Input	127-144	192.168.9.26
17	Input	145-162	192.168.9.27
18	Input	163-180	192.168.9.28
19	Input	181-198	192.168.9.29
20	Input	199-216	192.168.9.30

21	Input	217-234	192.168.9.31
22	Input	235-252	192.168.9.32
23	Input	253-270	192.168.9.33
24	Input	271-288	192.168.9.34
25	Output	145-162	192.168.9.35
26	Output	163-180	192.168.9.36
27	Output	181-198	192.168.9.37
28	Output	199-216	192.168.9.38
29	Output	217-234	192.168.9.39
30	Output	235-252	192.168.9.40
31	Output	253-270	192.168.9.41
32	Output	271-288	192.168.9.42
33	Output	289-306	192.168.9.43
34	Output	307-324	192.168.9.44
35	Output	325-342	192.168.9.45
36	Output	343-360	192.168.9.46
37	Output	361-378	192.168.9.47
38	Output	379-396	192.168.9.48
39	Output	397-414	192.168.9.49
40	Output	415-432	192.168.9.50
41	Input	289-306	192.168.9.51
42	Input	307-324	192.168.9.52
43	Input	325-342	192.168.9.53
44	Input	343-360	192.168.9.54
45	Input	361-378	192.168.9.55
46	Input	379-396	192.168.9.56
47	Input	397-414	192.168.9.57
48	Input	415-432	192.168.9.58
49	Input	433-450	192.168.9.59
50	Input	451-468	192.168.9.60
51	Input	469-486	192.168.9.61
52	Input	487-504	192.168.9.62
53	Input	505-522	192.168.9.63
54	Input	523-540	192.168.9.64
55	Input	541-558	192.168.9.65
56	Input	559-576	192.168.9.66
57	Output	433-450	192.168.9.67
58	Output	451-468	192.168.9.68
59	Output	469-486	192.168.9.69
60	Output	487-504	192.168.9.70
61	Output	505-522	192.168.9.71
62	Output	523-540	192.168.9.72
63	Output	541-558	192.168.9.73
64	Output	559-576	192.168.9.74
65	XPT	Top	192.168.9.75
66	XPT	Top	192.168.9.76
67	XPT	Redundant	192.168.9.77
68	XPT	Redundant	192.168.9.78
69	XPT	Bottom	192.168.9.79
70	XPT	Bottom	192.168.9.80
71	Monitor	LHS	192.168.9.81
72	Monitor	RHS	192.168.9.82
73	FC	Upper	192.168.9.83
74	FC	Lower	192.168.9.84

Table 10-1 : EQX Modules IP Addresses

10.4 ROUTE SETTINGS (MAP FILE SELECTION)

To configure EQX route mode and type of output modules, click on “Route Settings” tab. Route Settings window is shown in Figure 10-14, which provides a dropdown menu for Map selection and Output configuration option.

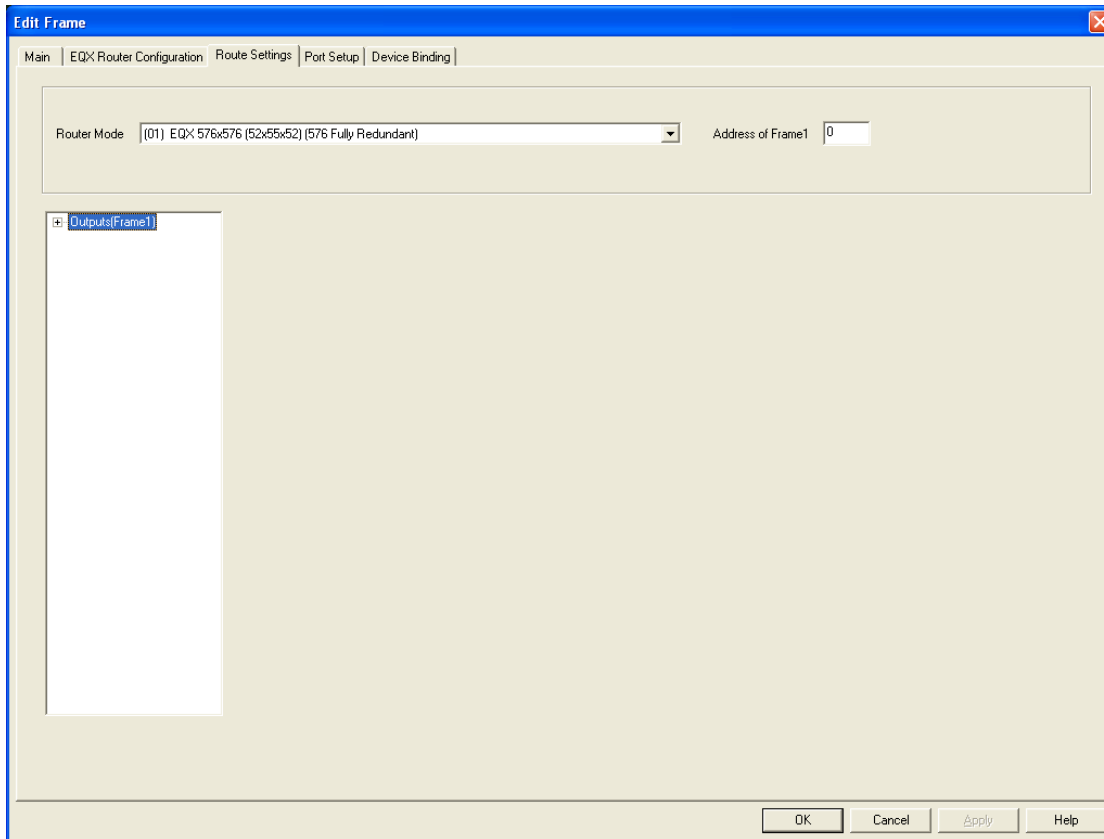

Figure 10-14 : Route Settings Window

10.4.1 Router Mode

Router Mode drop-down menu provides a list of Map files which allows the EQX to operate correctly based on the hardware and system requirement. Below is the list of some map files:

MAP00 -This map is used for 26RU frame with three 52 XPTs fitted. Since middle XPT provides only 288 redundant outputs, this map will allow these redundant outputs to be shared between top and bottom half outputs and it will be in the order of last failure takes priority.

MAP01 -This map is used for 26 RU frame with two 52 XPTs fitted in the top and bottom slots and one 55 XPT is fitted in the middle slot. Since middle XPT is 55, using this map will allow a full redundancy for top and bottom outputs.

MAP02 -This map is used for 26 RU frame with X-Link option. All three XPTs are 55 which will allow the system to have a full redundancy for the 1-576 plus 576 X-Link outputs without redundancy.

Table 10-2 below have the detail for all the available maps:

Map File	Frame Type	Matrix Size (no DD)	Config File Size	Number of Frames	Input module	Output module	XLINK O/P	XLINK ORDER	Top XPT	Middle XPT	Bottom XPT
Map 00	26RU	576x576	576x576	1	18	18	0	N/A	52	52	52
Map 01	26RU	576x576	576x576	1	18	18	0	N/A	52	55	52

Map 02	26RU+XL	576x1152	576x1728	1	18	18	18	Sequential	55	55	55
Map 03	26RU+XL	576x1152	576x1728	1	18	18	18	Sequential	55	52	55
Map 04	16RU+XL3	288x1152	288x1728	1	18	18	27	Sequential	55	22	22
Map 05	26RU+XL	1152X1152	1152X1156	2	36	36	0	N/A	2 x 55	2 x 55	2 X 55
Map 06	16RU+XL3	288x1152	288x1728	1	18	18	27	Sequential	55	55	22
Map 07	16RU+XL2	288x864	288x1152	1	18	18	18	Sequential	22	22	22
Map 08	16RU+XL2	288x864	288x1152	1	18	18	18	Mixed	22	55	22
Map 09	16RU+XL1	288x576	288x576	1	18	18	9	Mixed	22	22	22
Map 0A	26RU+XL	576x864	576x1728	1	18	18	9	Sequential	55	52	52
Map 0B	26RU+XL	576x864	576x1440	1	18	18	9	Sequential	55	55	52
Map 0C	16RU+XL2	288x864	288x576	1	18	18	9x2	Mixed	22	55	22
Map 0D	26RU+XL	576x1152	576X1152	1	18	18	0	N/A	55	55	55
Map 0E	26RU+XL	576x1152	576x1728	1	18	18	9x2	Sequential	55	52	55
Map 17	10RU+XL	180X288	180X1728	1	10	10	15	Sequential	12	12	12

Legend	
55	576x576
52	576x288
22	288x288
12	180x288

Table 10-2 : Maps for Router Mode

10.4.2 Outputs

Output window provides the option of selecting the correct number of outputs with correct RP type based on the hardware. Incorrect selection in this section could cause the output module to operate incorrectly. There are three different selections for the number of outputs and three selections for RP Type for each module in each slot.

Number of outputs “16”: This option is selected when an AVOP is fitted in that slot

Number of outputs “18”: This option is selected when a normal OP is fitted in that slot

Number of outputs “36”: This option is selected when a Double Density car is fitted in that slot

RP Type “Normal BNC”: This option is selected when BNC RP is fitted

RP Type “DD BNC”: This option is selected when DD RP is fitted

RP Type “XLINK”: This option is selected when XLINK RP is fitted

As an example if a DD module is fitted in slot1, 36 has to be selected for Number of Outputs and DD BNC for RP Type.

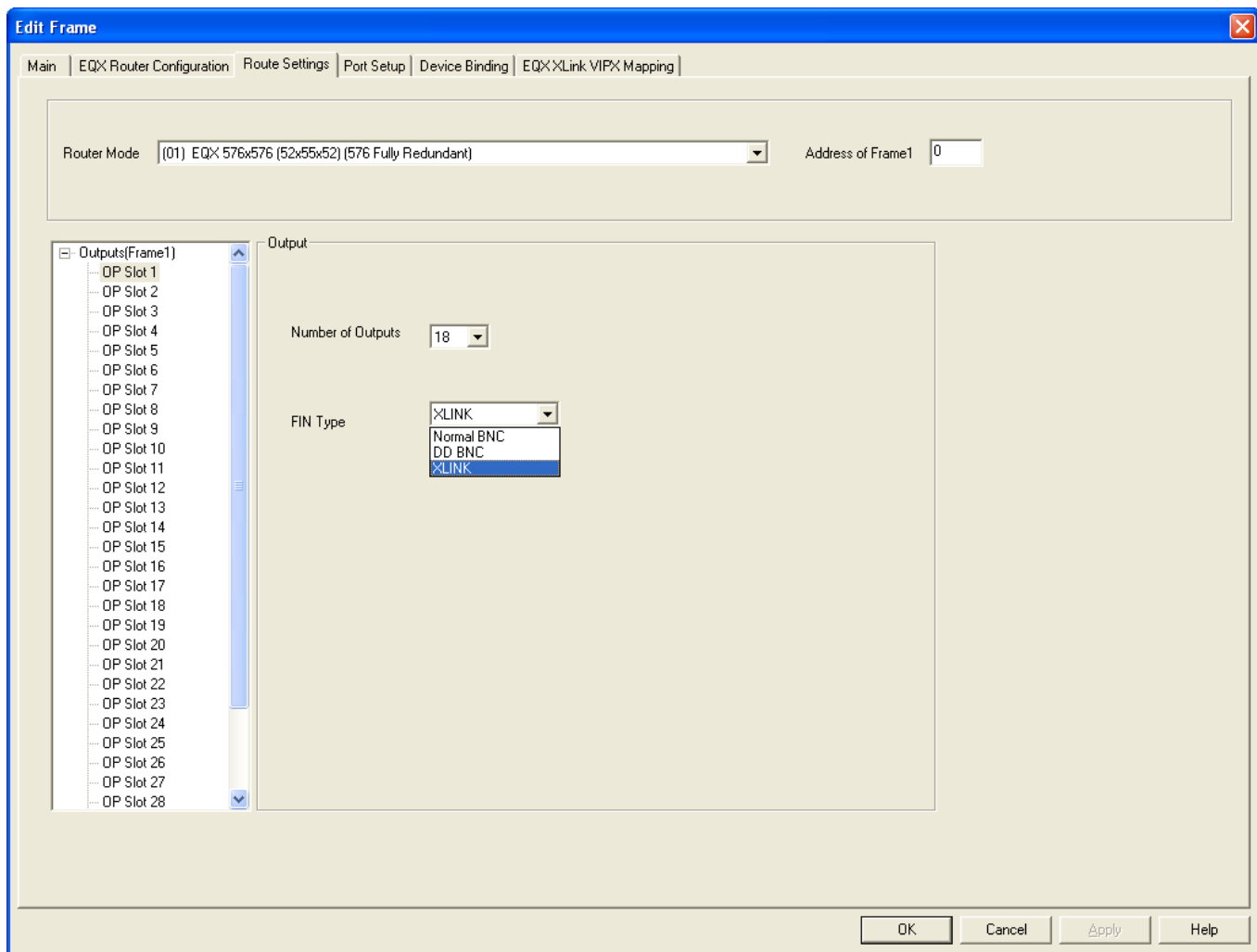

Figure 10-15 : Output Window Selection

10.5 PORT SETUP

EQX has several communications ports that require additional setup. This section is used to define all of the interfaces that will be connected to EQX. From Port Setup tab, ports can be added for Ethernet or serial control and Q-Link panel hosting.

- Serial Ports
- Q-Link Ports
- TCP Ports

10.5.1 Control Panel Q-Link Interface

The control panel Q-Link port is an interface that is defined to allow all properly equipped control panels to connect to EQX via Q-Link. The Q-Link port can be defined as a port to host panels using Q-Link. The interface is defined as a *QLINK1* interface using the *Qlink (Hosted Panels)* protocol. A properly configured setting is shown in Figure 10-16. In this configuration, control panels can be connected to the physical port that is labelled Q-Link 1 on the rear of the device.

10.5.2 Serial Interface

The serial port is an interface that is defined to provide external automation control of EQX. The interface is defined as a *Serial1* interface using the *Quartz* protocol. The format of the serial protocol is also defined in this dialog using the options that are provided for *Baud Rate*, *Parity*, *Data bits*, *Stop bits* and *Standard (RS232 or RS422)*. A properly configured serial port is shown in Figure 10-16.

10.5.3 Ethernet Interface

The Ethernet interface is defined to provide access to the EQX so that it can be controlled via Ethernet using Quartz protocol. Four ports can be added: 4000, 4001, 4002 and 4003. An example of a properly configured Ethernet port for external control is shown in Figure 10-16.



Note: Available TCP ports are 4000, 4001, 4002 and 4003. For redundant Magnum to work properly, Magnum interface port has to be defined twice.



Note: The total number of defined TCP ports should not exceed 4. The same ports can be defined more than once (e.g. 4000, 4000, 4001, 4001)

The screenshot displays the 'Edit Frame' window with the 'Port Setup' tab selected. It shows a list of 12 defined ports:

Port Name	Protocol	Settings
Serial 1	Quartz	(115200,8,N,1)
Serial 2	Quartz	(115200,8,N,1)
Serial 3	Quartz	(115200,8,N,1)
Serial 4	Quartz	(115200,8,N,1)
QLINK2	Qlink (Hosted Panels)	
QLINK1	Qlink (Hosted Panels)	
QLINK3	Qlink (QMC Router Protocol)	
QLINK4	Qlink (QMC Router Protocol)	
TCP	Quartz	(Port 4000)
TCP	Quartz	(Port 4001)
TCP	Quartz	(Port 4002)

Below the list are 'Add', 'Edit', and 'Remove' buttons. Two 'Port Settings' dialog boxes are overlaid on the main window:

- Top-left dialog:** Configured for 'Serial 1' interface using 'Quartz' protocol. Baud Rate is 115200, Parity is None, Data bits is 8, Stop bits is 1, and Standard is RS232.
- Top-right dialog:** Configured for 'QLINK1' interface using 'Qlink (Hosted Panels)' protocol.
- Bottom-left dialog:** Configured for 'Serial 1' interface using 'Quartz' protocol. Baud Rate is 115200, Parity is None, Data bits is 8, Stop bits is 1, and Standard is RS232.
- Bottom-right dialog:** Configured for 'TCP' interface using 'Quartz' protocol. Port is 4000, and 'Is client' is unchecked.

At the bottom of the main window are 'OK', 'Cancel', 'Apply', and 'Help' buttons.

Figure 10-16 : Ethernet Port Settings for External Control

10.6 DEVICE BINDING AND EQX XLINK VIPX MAPPING

These two tabs are not used.

10.7 SOURCES

The next stage is to create the “*Source table*”. The source table defines the number and names of the sources connected to the EQX router. To enter the “Source Definition” window click on the “Sources” button from the main menu.

Click on the “Add” button and first define the main sources by enabling the “Main” check box and add the relevant number of sources to the ‘Source Definition’ table. The software will prompt you to use default names - SRC-1 to SRC-n. The names can be edited later. Once the main sources are defined add the redundant sources by enabling the Backup check box and disabling the Main check box, systems with redundancy always have 6 backup sources.

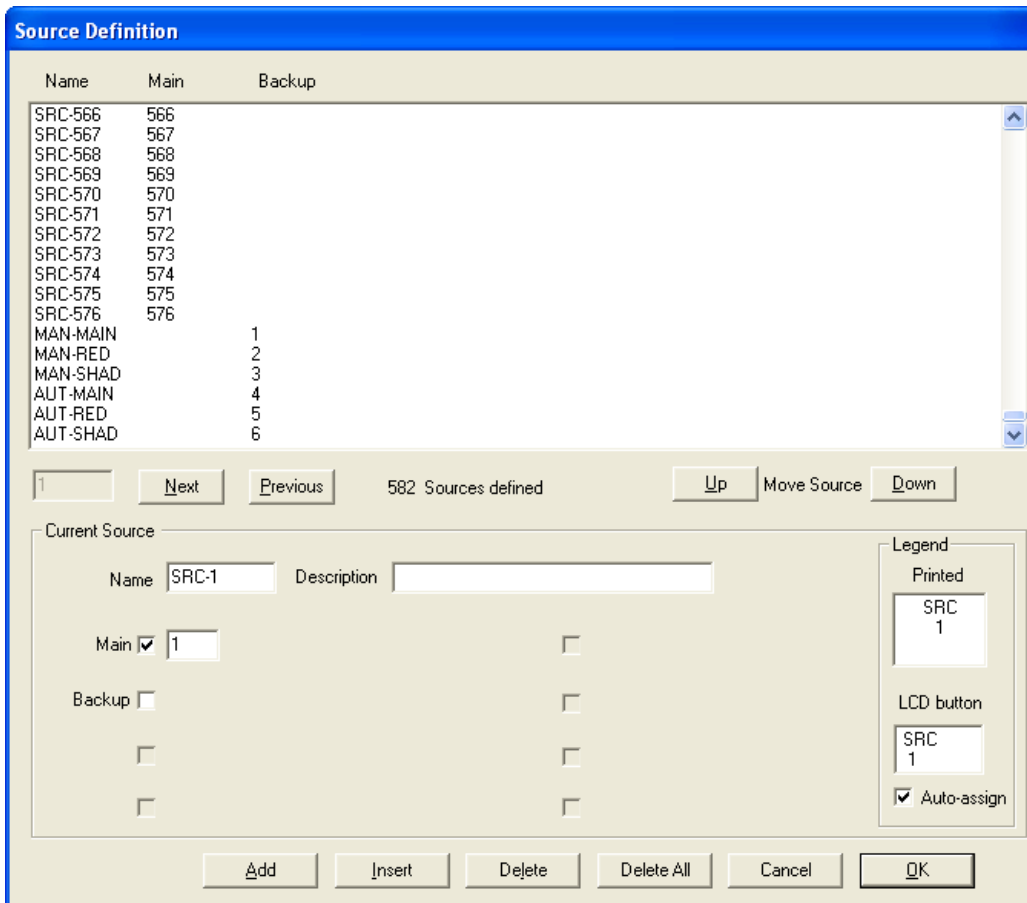

The screenshot shows the 'Source Definition' window with a table of sources and configuration options for the current source.

Name	Main	Backup
SRC-566	566	
SRC-567	567	
SRC-568	568	
SRC-569	569	
SRC-570	570	
SRC-571	571	
SRC-572	572	
SRC-573	573	
SRC-574	574	
SRC-575	575	
SRC-576	576	
MAN-MAIN		1
MAN-RED		2
MAN-SHAD		3
AUT-MAIN		4
AUT-RED		5
AUT-SHAD		6

Current Source configuration:

Name: SRC-1 Description: []

Main: 1

Backup:

Legend:

Printed: SRC 1

LCD button: SRC 1

Auto-assign

Figure 10-17 : Source Definition Window

If you want to edit a name, select the required row from the list of names in the upper part of the screen. The selection will be confirmed by a blue highlight behind the text. The details, such as the name and description of the selection will appear in the lower part of the screen. From here you can edit the name and decide which signal levels that name will control.

The ‘*Legend*’ area allows the printed or electronic (LCD) labels for the Control Panel buttons to be defined. Clicking the ‘*Auto-assign*’ button initiates the software to automatically create the text for the button labels

from the names used in the Source list. These labels can be overruled at any time by simply typing a new name directly into the relevant “*Legend*” box.

The last six Sources that are shown in the source list relate to the operation of the redundant crosspoint. The source routed on this level to a particular destination controls its crosspoint redundancy. The meaning of the values is as follows:

- 1) Main crosspoint selected
- 2) Redundant crosspoint selected
- 3) Main crosspoint selected, with auto switchover to redundant in the case of route failure detection.
- 4) Redundant crosspoint selected. At the moment there is no automatic switch back to main.
- 5) The redundant crosspoint will follow the main crosspoint settings, allowing faster changeover in the case of a failure.

Click OK to return to the main menu.

10.8 DESTINATIONS

Once the Source Definitions have been created the main menu will allow access into the ‘Destination Definition’ window where the ‘Destination table’ can be created. The destination table defines the number and names of the destinations connected to the EQX router. To enter the ‘Destination Definition’ window, click on the ‘Destination’ button from the main menu.

Click on the ‘Add’ button and make sure both Main and backup check boxes are enabled, add the relevant number of destinations to the ‘Destination Definition’ table. The software will prompt you to use default names - DST-1 to DST-n. The names can be edited later. The last four destinations are for monitoring and they have to be defined in Main level only.

Destination Definition

Name	Main	Backup
DST-564	564	564
DST-565	565	565
DST-566	566	566
DST-567	567	567
DST-568	568	568
DST-569	569	569
DST-570	570	570
DST-571	571	571
DST-572	572	572
DST-573	573	573
DST-574	574	574
DST-575	575	575
DST-576	576	576
DSTMON1	577	
SRCMON1	578	
DSTMON2	579	
SRCMON2	580	

545 Next Previous 580 Destinations defined Up Move Destination Down

Current Destination

Name: DST-545 Description:

Main 545

Backup 545

Legend

Printed

DST
545

LCD button

DST
545

Auto-assign

Add Insert Delete Delete All Cancel OK

Figure 10-18 : Destination Definition Window

If you want to edit a name, select the required row from the list of names in the upper part of the screen. The selection will be confirmed by a blue highlight behind the text. The details, such as the name and description of the selection will appear in the lower part of the screen. From here you can edit the name and decide which signal levels that name will control.

The 'Legend' area allows the printed or electronic (LCD) labels for the Control Panel buttons to be defined. Clicking the 'Auto-assign' button will initiate the software to automatically create the text for the button labels from the names used in the Destination list. These labels can be overruled at any time by typing a new name directly into the relevant 'Legend' box. The last four Destinations that are shown in the destination list are related to the operation of the EQX monitoring circuit. Click OK to return to the main menu.

10.9 CONTROL PANELS

Enter the 'Panels' dialog and select the new button. This will show all Quartz panels listed by part number. Select the part number that matches the part number on the panel's serial number label. A new dialog will appear displaying a graphic of the panel. The example below shows a CP-1000E panel type.

Figure 10-19 : Key Definition Window

Each button can be programmed by selecting the button and then editing the functions in the *Key* section of the dialog. It is also recommended that each panel should be given a name for future identification. It is common practice for the name to reflect the panel's location, for example "Backup".

The Q-Link address will be allocated automatically by the program but can be edited and has to match the physical Q-Link address of the panel. The default parameters control how the panel will function at power up. In this example the panel will always control DST-1 to start. Once setup, add any other panels that the system will need.



Note: Each panel will be automatically allocated a Q-Link address (which can be changed).



Note: Ensure that the physical Q-Link address switch on the Control Panel matches the Q-Link address set in your configuration.

10.10 SPECIAL INTERFACES

IF the system will be connected to an EMC/QMC, please refer to EMC/QMC manual for configuring Special interfaces.

10.11 COMMUNICATION WINDOW

Use the Communication Window to check for correct setup and working communication between the PC and the router.

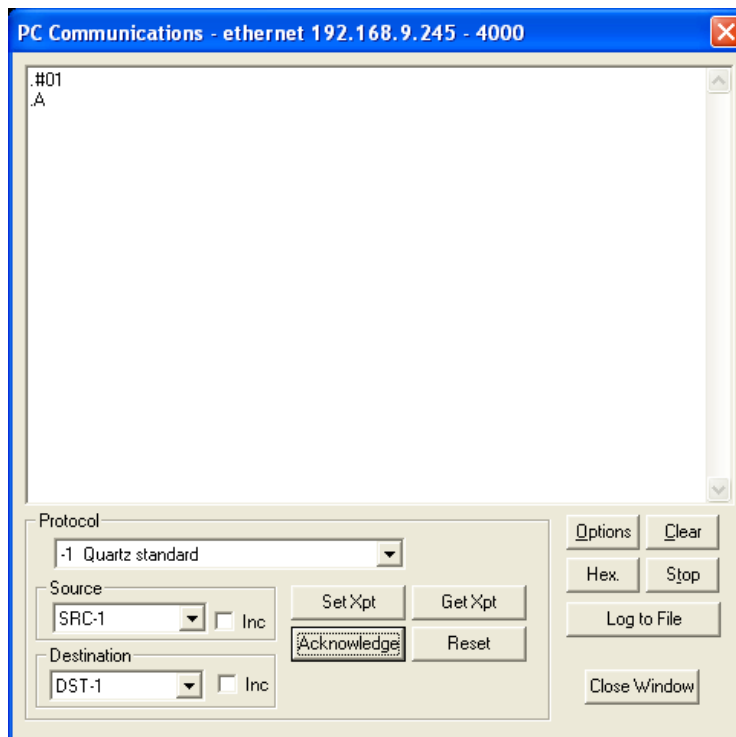

Figure 10-20 : COM1 Window

Click the 'Comm Window' tab and the window shown in Figure 10-20 will open automatically. From the Protocol drop down list select *-1 Quartz Standard*. Click the "Acknowledge" button and WinSetup will send ".#01". Look for a response to the send command in the window. This response should be ".A". If a response is not seen, check the settings under the options button. A response confirms the communication is OK between the PC and the Router.



Note: Use the Comm Window to check the communication between the router and the PC.

10.12 DOWNLOAD

Once the communication between the router and PC is established via Ethernet, close the Comms. Window and download the configuration to EQX-FC by pressing the “DOWNLOAD” button



Note: Note: Make sure the configuration is saved before closing the WinSetup.



Note: Config download can be done via Ethernet only and port 25 is the default to be used

This page left intentionally blank

11 FIRMWARE UPGRADE

There are two ways of upgrading modules in EQX, FTP and serially. FTP is a lot faster and requires Ethernet connection; on the other hand, serial upgrade is very time consuming and does not require any Ethernet connection.

11.1 FTP METHOD

11.1.1 UPGRADING FRAME CONTROLLER

1. Identify and confirm the IP addresses of the module and PC/laptop, and ensure that they are on the same subnet.
2. Power on the EQX system with the module installed in the EQX frame.
3. Obtain the new application code and place it on the PC's local drive.
4. Open a DOS window by selecting Start > Run, and typing "cmd" in the window that appears,



5. In the DOS window type: **ftp xxx.xxx.xxx.xxx** (where the x's represent the FC's IP address).
6. Press <ENTER> when prompted for a "Username", and again when prompted for a "Password".
7. At the "FTP>" prompt, type "cd.." the press enter to go back in the folder
8. At the "FTP>" prompt, type "cd [boot]" to go inside the boot folder
9. Then at the "FTP>" prompt, type "put x.bin", where x represents the name of the application (.bin) file.



**Note: If the application file is not local to where you are performing the FTP, then include the path with the name:
(e.g.: "put c:\temp\eqxfirmware.bin")**

10. Once the upgrade is complete, send the command "bye" to exit ftp connection
11. Once the upgrade is complete, the reboot FC to use the new firmware

11.1.2 UPGRADING I/O AND MONITOR MODULES

1. Identify and confirm the IP addresses of the module and PC/laptop, and ensure that they are on the same subnet.
2. Power on the EQX system with the module installed in the EQX frame.
3. Obtain the new application code and place it on the PC's local drive.
4. Open a DOS window by selecting **Start > Run**, and typing "cmd" in the window that appears,

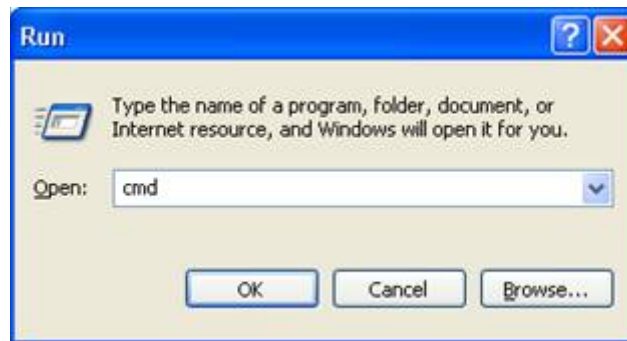

5. In the DOS window type: **ftp xxx.xxx.xxx.xxx** (where the x's represent the module's IP address).
6. Press <ENTER> when prompted for a "Username", and again when prompted for a "Password".
7. At the "FTP>" prompt, type "put x.bin", where x represents the name of the application (.bin) file.



Note: If the application file is not local to where you are performing the FTP, then include the path with the name:

(e.g.: "put c:\temp\eqx\firmware.bin")

8. Once the upgrade is complete, send the command "bye" to exit ftp connection
9. Once the upgrade is complete, the module will reboot itself. Do not remove the module during this process or it could corrupt the application code.

11.2 SERIAL METHOD

This method transfers the new application code via the upgrade serial port on the front edge of the module.

1. Turn off the EQX frame containing the module that is to be upgraded.
2. Connect the factory-supplied 7700PB serial upgrade cable on the front edge of the module, and connect the other end of this cable to a serial port on a PC with a serial terminal program.
3. Set up the serial communication properties for the COM port as follows:

COM:	Select the COM port
Bits per second:	115200
Data bits:	8
Parity:	None
Stop bits:	2
Flow control:	None

4. Set the upgrade jumper from “Run” to “Upgrade”.
5. Power on the EQX frame with the module installed.
6. When the module boot-up send command “Ctrl + X” through keyboard, it will send the module to “PPCBOOT>” mode.
7. At the prompt type “upgrade”, then press <ENTER>
8. The following message will be displayed: *“Upload product firmware now”*
9. Upload the application code by using the *send file* function in the terminal software. When prompted, use the “Xmodem” protocol for data transfer.
10. When the transfer is complete (which can take up to 30 minutes or more) the terminal will return to the PPCBOOT prompt. You should:
11. Turn off the EQX frame.
12. Set the upgrade jumper to “Run”.
13. Remove the upgrade serial cable and re-insert the module in side the frame.

This page left intentionally blank

12 IP ADDRESSES CONFIGURATION FOR FLINK SYSTEM

12.1 EQX FRAME CONTROLLER(S) IP ADDRESS CONFIGURATION

Connect the upgrade cable to the upgrade four pin header (J13) of the Frame Controller. Pressing <ENTER> on the keyboard will bring up the Main Menu as shown in Figure 12-1.

```
-----  
(1) Network Configuration  
(2) Serial Port Setup  
(3) SNMP Setup  
(4) Status Monitoring  
(5) Runtime Statistics - Engineering Only  
(6) Engineering/Debug  
  
(X) Exit  
>  
-----
```

Figure 12-1 : HyperTerminal Main Menu

To open a menu item, type the corresponding number from the list, and then press <ENTER>.



Note: Remember to SAVE when a change has been made before exiting the menu.

Selecting menu item (1) *Network Configuration* from the Main Menu will enable the user to set the IP address properties for the Frame Controller.

```
-----  
network 1 (backplane 'B' and Front connector) is enabled  
MAC: 00:02:c5:10:90:00  
ip address: 192.168.9.83  
netmask address: 255.255.255.0  
multicast address 1: 0.0.0.0  
broadcast address: 192.168.9.255  
-----  
gateway: 192.168.9.1  
remote address: 192.168.0.2  
-----  
network 2 (inter FC) is enabled  
ip address 2: 192.168.0.1  
netmask address 2: 255.255.255.0  
multicast address 2: 0.0.0.0  
-----  
network 3 (backplane 'A') is enabled  
ip address 3: 192.168.10.83  
netmask address 3: 255.255.255.0  
multicast address 3: 0.0.0.0  
-----  
(1) Set IP Address 1  
(2) Enable Network 1
```

```
(3) Set Netmask 1
(4) Set Multicast Address 1
(5) Set Broadcast Address
(6) Set Gateway
(7) Set remote IP Address
(8) Enable Network 2
(9) Set IP Address 2
(10) Set Netmask 2
(11) Set Multicast Address 2
(12) Enable Network 3
(13) Set IP Address 3
(14) Set Netmask 3
(15) Set Multicast Address 3

(S) Save and Exit
(X) Exit
>
```

Figure 12-2 : Network Configuration Menu

In the above menu (), selecting options (1) through (13) allows the user to set the networking parameters of the Frame Controller. DHCP is not recommended as control of the EQX requires static IP addresses. Once completing the IP configurations, save and exit this menu by selecting the “S” option. All modules ship with DHCP disabled (or DHCP enabled set to “FALSE”). If you are not sure whether you should use this option, contact your networking/IT administrator.

Option (8) network 2 is called inter FC IP address, it allows the FC’s in the frame to talk to each other. For Option (7) the Inter FC IP address of the redundant FC’s is the remote IP address for main FC and the Inter FC IP address of main FC is the remote IP address for redundant FC. Remote IP address has to be set in both FC’s. After the config is saved and exited the menu, the frame controller will need to be rebooted.



Note: If the remote IP addresses are not set correctly, both FC’s will become in control, which will cause unnecessary issues in the frame.



Warning: Inter FC IP addresses have to be unique and there should not be any other device with the same IP in the Network.

12.2 IP ADDRESS CONFIGURATION FOR ALL OTHER EQX MODULES

The IP address of each module within the EQX has been pre-assigned to the values shown in this document for testing purposes. They can be left as they are or changed to a value that better reflects your exact network topology.

There are two separate Ethernet networks within the EQX router, 'A' and 'B'. Each network has two RJ45 connectors mounted onto the rear of the EQX frame. Network 'A' is used to interface with controllers such as Magnum or third party controllers and Network 'B' is used for SNMP monitoring. The modules inside the frame have to be in the same subnet as the Network 'B'.

For information on how to set the IP addresses of the modules please refer to section 10.3.6 Ethernet Configuration.



Note: It is important that the factory configured IP Addresses are documented before any changes are made.

This page left intentionally blank

13 TECHNICAL DESCRIPTION

13.1 SPECIFICATIONS

13.1.1 Configuration

EQX26:	576x576 in 26RU	(PSU separate 1RU)
EQX16:	288x288 in 16RU	(PSU separate 1RU)
EQX10:	180X180 in 10RU	(PSU separate 1RU)
Inputs:	Selectable in blocks of 18	
Outputs:	Selectable in blocks of 18	
Redundant Protection:	Redundant Crosspoint Redundant Frame Controller Redundant Power Supply Redundant Cooling Fans	

13.1.2 Video Inputs

Standards:	SMPTE 259M, SMPTE 292M, SMPTE 310M, SMPTE 424M, ASI
Signal Level:	800mV p-p
Impedance:	75Ω terminating
Return Loss:	>15db typical (5-1500 MHz) >10db typical (1.5-3GHz)

Cable Equalization:	Belden 1694 @ 270 MHz 300m Belden 1694 @ 1.5GHz 100m
----------------------------	---

Connectors:	BNC per IEC 61169-8 Annex A, DIN 1.0/2.3
Optical Sensitivity:	-22 dBm
Optical Wavelength:	1260nm – 1620nm
Optical Format:	Single Mode

13.1.3 Video Outputs

Signals Supported:	SMPTE 259M, SMPTE 292M, SMPTE 310M, SMPTE 424M, ASI
Reclocking:	Configurable
Non-Reclocking:	Configurable
Signal Level:	800mV p-p ± 10%
Impedance:	75Ω terminating
Return Loss:	>15 db typical (5-1500 MHz) >10db typical (1.5-3GHz)
DC Offset:	0 ± 0.5V
Output Jitter:	0.2 UI
Connectors:	BNC per IEC 61169-8 Annex A, DIN 1.0/2.3
Average Optical Power:	-5 dBm
Optical Wavelength:	1310nm
Optical Format:	Single Mode

13.1.4 Fiber Output/Input

SFP3T13-2: Dual Optical SFP Transmitter, Up to 3Gb/s, 1310nm
Connector: LC/PC
Wavelengths: 1310nm
Output Power: -2dBm \pm 1dBm

SFP3R-2: Dual Optical SFP Receiver, Up to 3Gb/s
Connector: LC/PC
Wavelengths: 1270nm to 1610nm
Maximum Input Power: -1dBm
Optical Sensitivity: -21dBm+/-1dBm

13.1.5 Reference Timing

Switching Reference: Analog 525/625/tri-level HD looping connections
Connector: 2 BNC per IEC 61169-8 Annex A
Signal Level: 1 V p-p \pm 3dB
Impedance: 75 Ω terminating active loop out optional
Reference Timing: 4 independent timing planes, programmable output by output

13.1.6 Control

Q-Link: 4x 75 Ω video cable (max length 500m)
Serial RS422/232: 4x D9 female
Ethernet: 10/100baseT, 4x RJ45

13.1.7 Physical

Height:
EQX-26FR: 45.5" (115.5cm) 26RU
EQX-16FR: 28" (49cm) 16RU
EQX-10FR: 17.5" (44.5cm) 10RU
Width: 19" (483mm) 19" Rack Mount
Depth: 19.4" (493mm) over hinges and BNCs
Weight:
EQX-26FR: 374Lbs (171Kg) Fully Loaded
EQX-16FR: 218Lbs (99Kg) Fully Loaded
EQX-10FR: 124Lbs (56Kg) Fully Loaded
Operating Temperature: 0°C to 40°C
Cooling: Fan cooled, front to rear

13.1.8 Electrical – Router

Input Voltage: 48 VDC
Typical Input Power: 700 W for fully loaded 180X288 configurations
 1100 W for fully loaded 288x288 configurations
 2100 W for fully loaded 576x576 configurations

Redundancy: Separate 1RU frame with up to 4 PS modules for 1:1 redundancy available

13.1.9 Electrical – External Power Supply

Configuration:	Up to 4 load sharing PS modules in 1RU frame
Connector:	IEC 60320 - separate mains input for each PS module
Input Voltage:	Auto ranging 100 ⇔ 240V nominal, 50/60Hz
Maximum Input Current:	13.2 A (@ 120 VAC), 7.2 A (@ 220 VAC) per PS module at 1200W load
Output Voltage:	48 VDC
Output Power:	1200 Watts per PS module

13.2 CONNECTOR PIN-OUTS

13.2.1 Serial Ports

The EQX router supports four (4) rear I/O Serial ports. Each of the four serial ports connects directly to each of the EQX frame controllers.

The serial ports are typically used for the connection of third party control devices, such as automation systems.



Note: It is recommended that Serial Port 1 is left available for the connection of the PC running the EQX configuration software (WinSetup).

The pin-out for the Serial ports is shown in Table 13-1:

RS422 9 PIN FEMALE D-TYPE	
PIN	SIGNAL
1	0V
2	Tx-
3	Rx+
4	0V
5	-
6	0V
7	Tx+
8	Rx-
9	-

Table 13-1 : RS422 Serial Port Pin-out

As an option, it is possible to convert either of the two serial ports to RS232 with the following pin-out.

RS232 9 PIN FEMALE D-TYPE	
PIN	SIGNAL
1	0V
2	RTS
3	RXD
4	0V
5	-
6	0V
7	TXD
8	CTS
9	-

Table 13-2 : RS232 Serial Port Pin-out

The Serial Ports are set to RS422 or RS232 via the WinSetup configuration software.

13.2.2 Ethernet Connections

There are two RJ-45 network connectors on the rear panel. The RJ-45 connectors are Ethernet port used for monitoring and control of the system, etc. See section 13.2.3 for information on connecting to an Ethernet network. See section 12 for information on configuring the network address for the router.

13.2.3 Connecting to an Ethernet Network

The EQX uses 10Base-T (10 Mbps), 100Base-TX (100 Mbps) or Gigabit (1Gbps) twisted pair Ethernet cabling systems. When connecting for 10Base-T systems, category 3, 4, or 5 UTP cable as well as

EIA/TIA – 568 100Ω STP cable may be used. When connecting for 100Base-TX systems, category 5 UTP cable is required. The cable must be “straight-through” with a RJ-45 connector at each end. Establish the network connection by plugging one end of the cable into the RJ-45 receptacle of the EQX and the other end into a port of the supporting hub.

The straight-through RJ-45 cable can be purchased or can be constructed using the pin-out information in Table 13-3. A colour coded wiring table is provided in Table 13-3 for the current RJ-45 standards (AT&T 258A or EIA/TIA 258B colour coding shown). Also refer to the notes following the table for additional wiring guide information.

Pin #	Signal	EIA/TIA 568A	AT&T 258A or EIA/TIA 568B	10BaseT or 100BaseT
1	Transmit +	White/Green	White/Orange	X
2	Transmit –	Green/White or White	Orange/White or Orange	X
3	Receive +	White/Orange	White/Green	X
4	N/A	Blue/White or Blue	Blue/White or Blue	Not used (required)
5	N/A	White/Blue	White/Blue	Not used (required)
6	Receive –	Orange/White or Orange	Green/White or Green	X
7	N/A	White/Brown	White/Brown	Not used (required)
8	N/A	Brown/White or Brown	Brown/White or Brown	Not used (required)

Table 13-3 : Standard RJ-45 Wiring Colour Codes

Note the following cabling information for this wiring guide:

- Only two pairs of wires are used in the 8-pin RJ-45 connector to carry Ethernet signals.
- Even though pins 4, 5, 7 and 8 are not used, it is mandatory that they be present in the cable.
- 10BaseT and 100BaseT use the same pins (a crossover cable made for one will also work with the other).
- Pairs may be solid colours and not have a stripe.
- Category 5 cable must use Category 5 rated connectors.

The maximum cable run between the router and the supporting hub is 300 ft (90 m). The maximum combined cable run between any two end points (i.e. router and PC/laptop via network hub) is 675 feet (205 m).

13.2.4 Alarm Connector

A 3-pin alarm terminal provides external alarm indication. The alarm signal conforms to SMPTE 269M Standard for fault reporting in television systems. This is a simple interface over which television equipment can report the occurrence of internal failures and faults in incoming signals. It is intended for use in all television equipment.

The interface consists of an isolated closure, which can assume one of three states: open, closed, or pulsing. Respectively, the three signal states indicate that either the reporting device is okay, has detected an internal fault, or is detecting incoming signal faults.

The EQX may be in one of three states:

1. **Normal Operation:** The EQX is currently not detecting any internal failures and is receiving power.
2. **Internal Failure:** The EQX is currently detecting an internal failure or has lost power.

3. **Incoming Signal Fault:** The EQX is not detecting any internal failures, but is currently detecting faults in incoming signal(s).

This requires that the user connect an external fault indicator and power supply to the alarm terminals. The power supply should be 24 VDC max and the current should be limited to 20mA (See SMPTE 269M for further details). The pin-out for the Alarm connector is shown in Table 13-2.

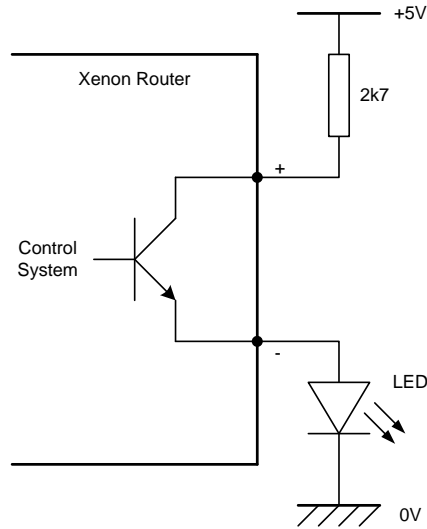

Figure 13-1 : Example Alarm Circuit

14 VISTALINK[®] REMOTE MONITORING/CONTROL

14.1 WHAT IS VISTALINK[®]?

VistaLINK[®] is Evertz' remote monitoring and configuration platform which operates over an Ethernet network using Simple Network Management Protocol (SNMP). SNMP is a standard computer network protocol that enables different devices sharing the same network to communicate with each other. *VistaLINK*[®] provides centralized alarm management, which monitors, reports, and logs all incoming alarm events and dispatches alerts to all the VLPRO Clients connected to the server. Module configuration through *VistaLINK*[®] PRO can be performed on an individual or multi-module basis using simple copy and paste routines, which reduces the time to configure each module separately. Finally, *VistaLINK*[®] enables the user to configure devices in the network from a central station and receive feedback that the configuration has been carried out.

There are 3 components of SNMP:

1. A SNMP manager, also known as a Network Management System (NMS), is a computer running special software that communicates with the devices in the network. Evertz *VistaLINK*[®] Pro Manager graphical user interface (GUI), third party or custom manager software may be used to monitor and control Evertz *VistaLINK*[®] enabled fiber optic products.
2. Managed devices (such as EQX), each with a unique address (OID), communicate with the NMS through an SNMP Agent.
3. A virtual database, known as the Management Information Base (MIB) lists all the variables being monitored, which both the Manager and Agent understand. Please contact Evertz for further information about obtaining a copy of the MIB for interfacing to a third party Manager/NMS.

14.2 VISTALINK® REMOTE MONITORING/CONTROL FOR EQX-FC

14.2.1 General Monitoring for EQX-FC

The following figure (Figure 14-1) shows the General Monitoring tab for EQX-FC.

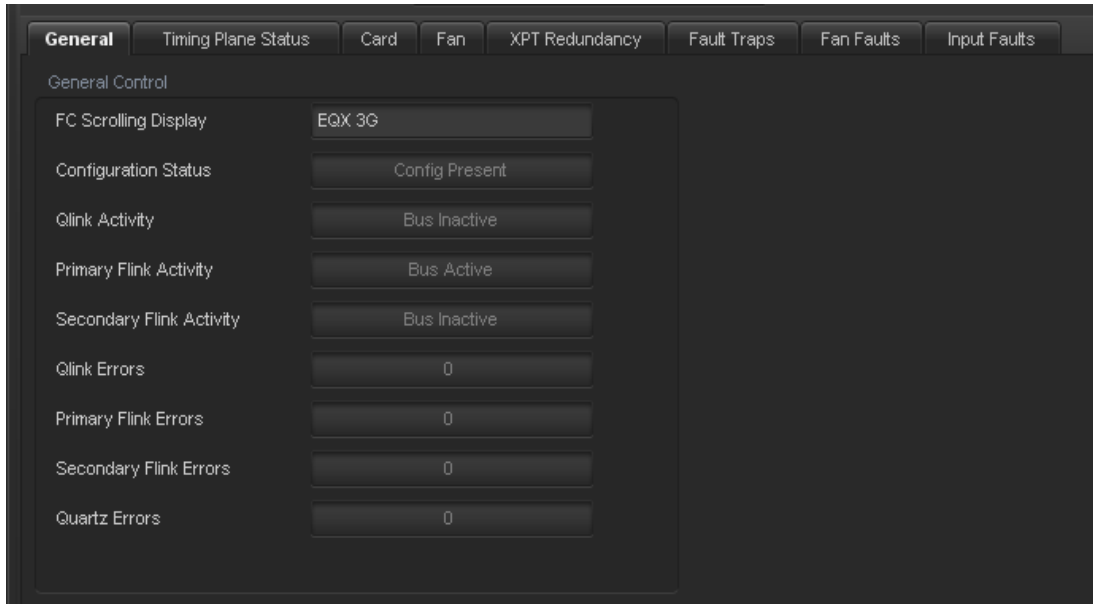

Figure 14-1 : General Monitoring Tab for EQX-FC

Table 14-1 below provides the further details on each parameter:

Parameter	Description
FC scrolling Display	The Dot Matrix scrolling text can be set here.
Configuration Status	Shows the presence of configuration in the CF.
Qlink Activity	Shows whether the Qlink is active or not.
Primary Flink Activity	Shows whether the primary Flink is active.
Secondary Flink Activity	Show whether the secondary Flink is active.
Errors	Show number of error for Qlink, primary and secondary Flink and general error.

Table 14-1 : EQX-FC Parameter

14.2.2 Timing Plane Status

The following figure (Figure 14-2) shows the Timing Plane Status for EQX-FC.

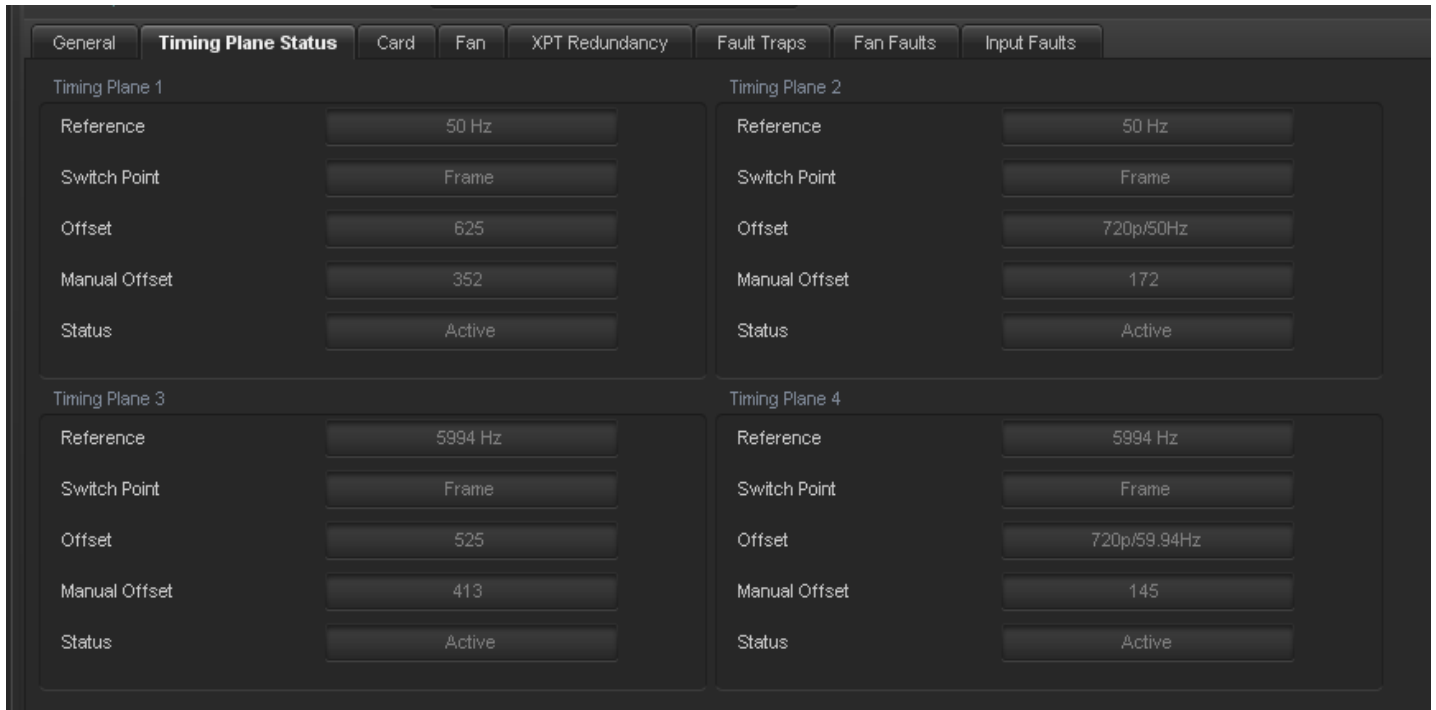

Figure 14-2 : Timing Plane Status for EQX-FC

Table 14-12 below provides the further details on each parameter:

Parameter	Description
Timing Plane 1, 2, 3 & 4	Shows the settings for each timing plane.

Table 14-2 : Timing Plane Parameter for EQX-FC

14.2.3 Module Status

The following figure (Figure 14-3) shows the modules Status for EQX-FC.

Slot No.	Type	Address	Status	Departure Count
1		Card Missing	Not Fitted	0
2	EQX Output 3G	192.168.11.11	Communicating	0
3	EQX-OP18-3G	0.0.0.0	Communicating	0
4		Card Missing	Not Fitted	0
5	EQX-OP18-3G	0.0.0.0	Communicating	0
6	EQX Output 3G	192.168.11.15	Communicating	0
7		Card Missing	Not Fitted	0
8		Card Missing	Not Fitted	0
9	EQX INPUT 3G	192.168.11.18	Communicating	0
10	EQX-INPUT-3G	0.0.0.0	Communicating	0
11	EQX-G-IP18	192.168.11.20	Communicating	0
12		Card Missing	Not Fitted	0
13		Card Missing	Not Fitted	0
14	EQX INPUT 3G	192.168.11.23	Communicating	0
15		Card Missing	Not Fitted	0
16		Card Missing	Not Fitted	0
17		Card Missing	Not Fitted	0
18		Card Missing	Not Fitted	0
19		Card Missing	Not Fitted	0

Figure 14-3 : Module Status for EQX-FC

Table 14-3 below provides the further details on each parameter:

Parameter	Description
Module Status	Shows slot number, module type, IP address of the module and number of departure.

Table 14-3 : Module Status Parameter for EQX-FC

14.2.4 Fan Status

The following figure (Figure 14-4) shows the Fan Status in the frame.

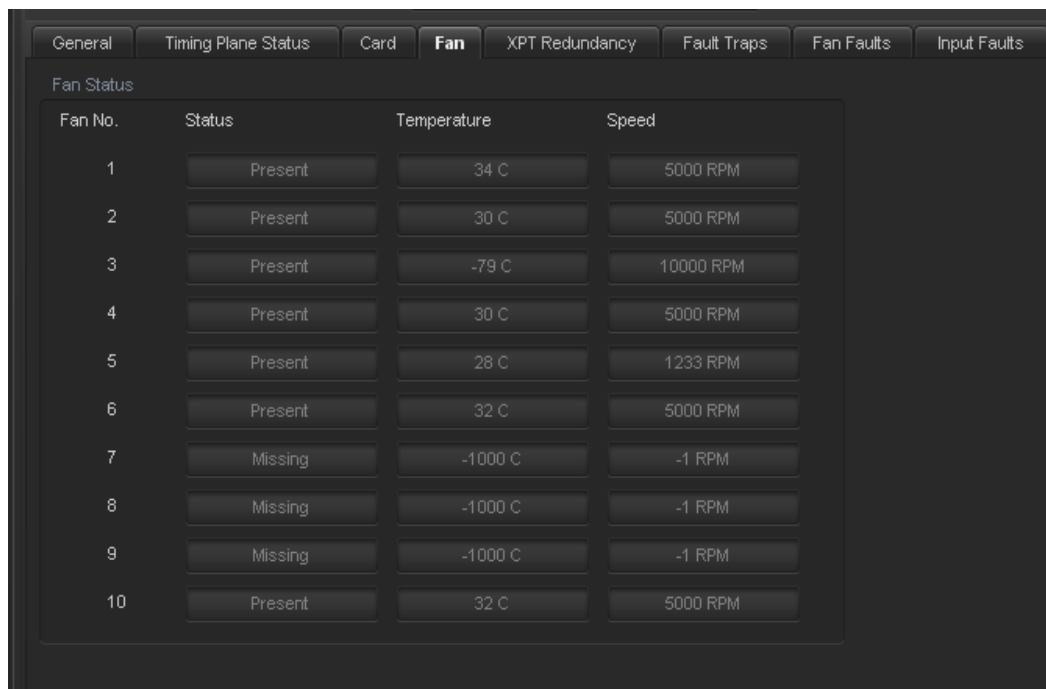

Figure 14-4 : Fan Status for EQX-FC

Table 14-4 below provides the further details on each parameter:

Parameter	Description
Fan Status	Shows the presence, Temperature and speed of each cooling fan in the frame.

Table 14-4 : Fan Status Parameter

14.2.5 Output status

The following figure (Figure 14-5) shows the output Status.

Redundancy Output No.	XPT Active	XPT Redundancy Mode
1	Main XPT	Automatic Control
2	Main XPT	Automatic Control
3	Main XPT	Automatic Control
4	Main XPT	Automatic Control
5	Main XPT	Automatic Control
6	Main XPT	Automatic Control
7	Main XPT	Automatic Control
8	Main XPT	Automatic Control
9	Main XPT	Automatic Control
10	Main XPT	Automatic Control
11	Main XPT	Automatic Control
12	Main XPT	Automatic Control
13	Main XPT	Automatic Control
14	Main XPT	Automatic Control
15	Main XPT	Automatic Control
16	Main XPT	Automatic Control
17	Main XPT	Automatic Control
18	Main XPT	Automatic Control

Figure 14-5 : Output Status for EQX-FC

Table 14-5 below provides the further details on each parameter:

Parameter	Description
Output Status	Shows whether the outputs are coming from Main XPT or Redundant XPT also it shows what mode the XPT redundancy is set to.

Table 14-5 : Output Status for EQX-FC

14.2.6 Fault Traps, Fan Fault and Input fault

The following figure (Figure 14-6) shows the Fault Trap tab:

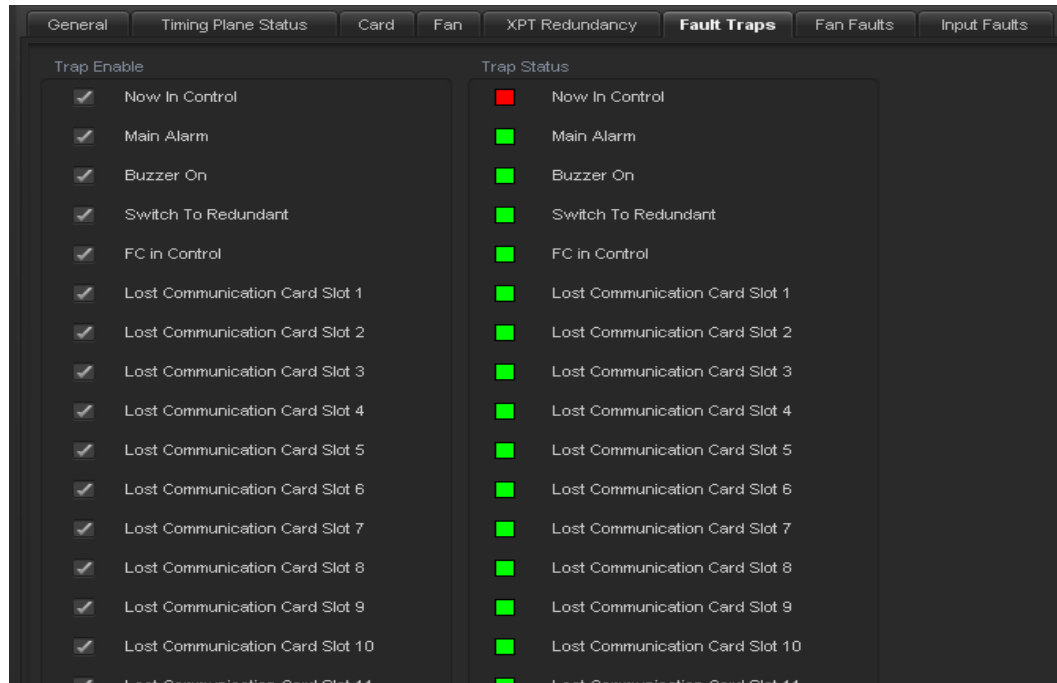

Figure 14-6 : Fault Trap Tab for EQX-FC

Table 14-6 below provides the further details on each parameter:

Parameter	Description
Fault Trap	Set or view traps for communication loss with modules, FC in control, fail to redundant, buzzer and alarm status change.
Fan Fault	Set or view traps for communication loss with Fan, temperature and speed.
Input Fault	Set or view input signal status change.

Table 14-6 : Fault Trap Parameter for EQX-FC

14.3 VISTALINK® REMOTE MONITORING/CONTROL FOR EQX-IP18-3G/G/XIO

14.3.1 Main Tabs for EQX Input module

The following figure (Figure 14-7) shows the Main tabs for EQX Input:

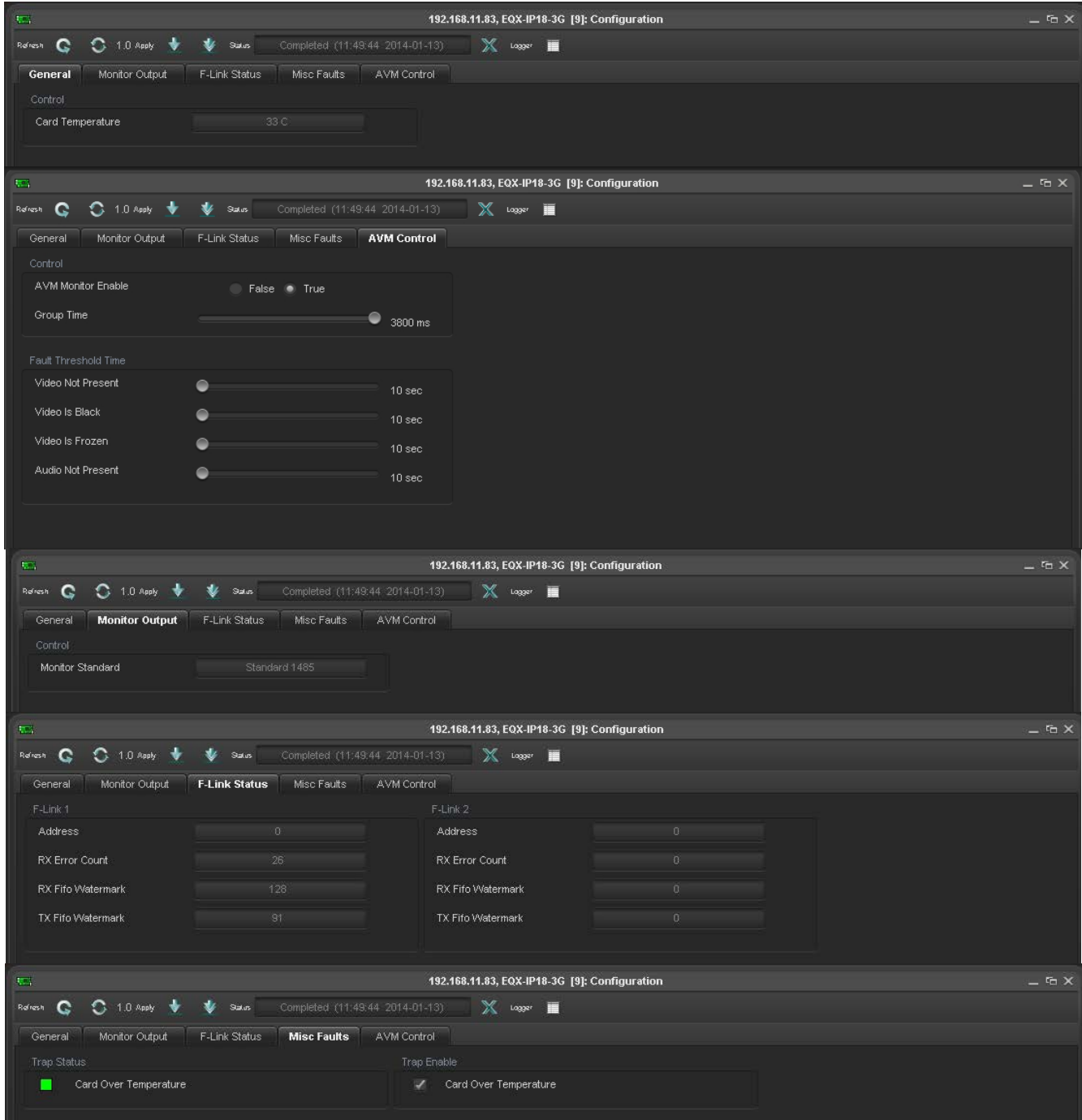

Figure 14-7 : Main Tabs for EQX Input

Table 14-7 below provides the further details on each Tab:

Parameter	Description
General	Shows the internal temperature of the module.
Monitor Output	Shows the standard of signal going to monitor output.
F-Link Status	Shows the Main and Redundant Flink status.
Misc Fault	Set or view trap for module over temperature.
AVM Control	Enable or disable AVM monitoring. Set the threshold time for frozen, black or missing video and Audio.

Table 14-7 : Main Tabs Description for EQX Input

14.3.2 Tabs for Individual Input

The following figure (Figure 14-8) shows the tabs individual Input:

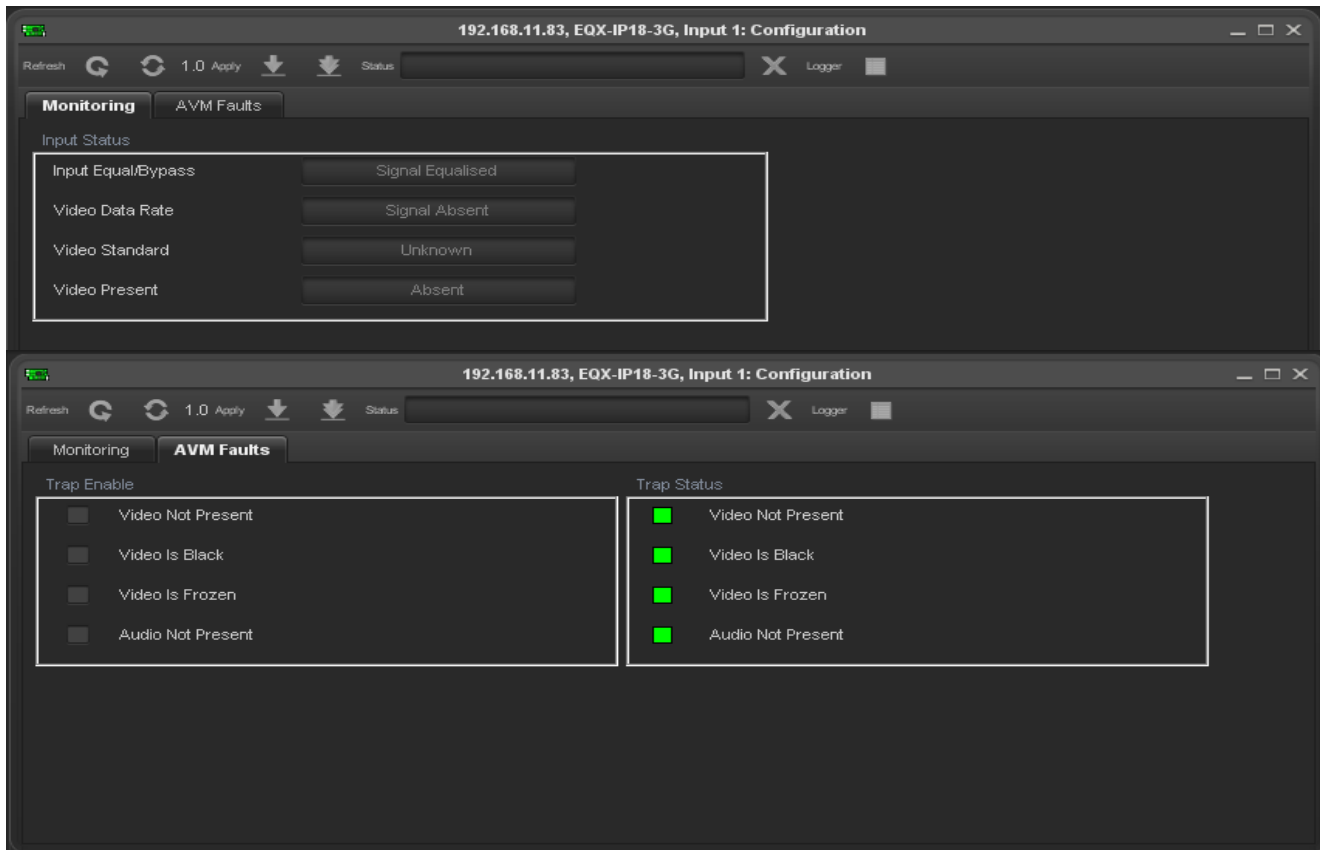

Figure 14-8 : Tabs for Individual Input

Table 14-8 below provides the further details on each parameter:

Parameter	Description
Monitoring	Shows whether the input is equalized or bypassed. Displays the video status.
AVM Fault	Set or view traps for black video, Frozen or missing and missing audio.

Table 14-8 : Individual Input Tabs Description

14.4 VISTALINK® REMOTE MONITORING/CONTROL FOR EQX-IP16AD/3G/F1

14.4.1 Main Tabs for AVIP/F1 Module

The following figure (Figure 14-9) shows the Main tabs for AVIP:

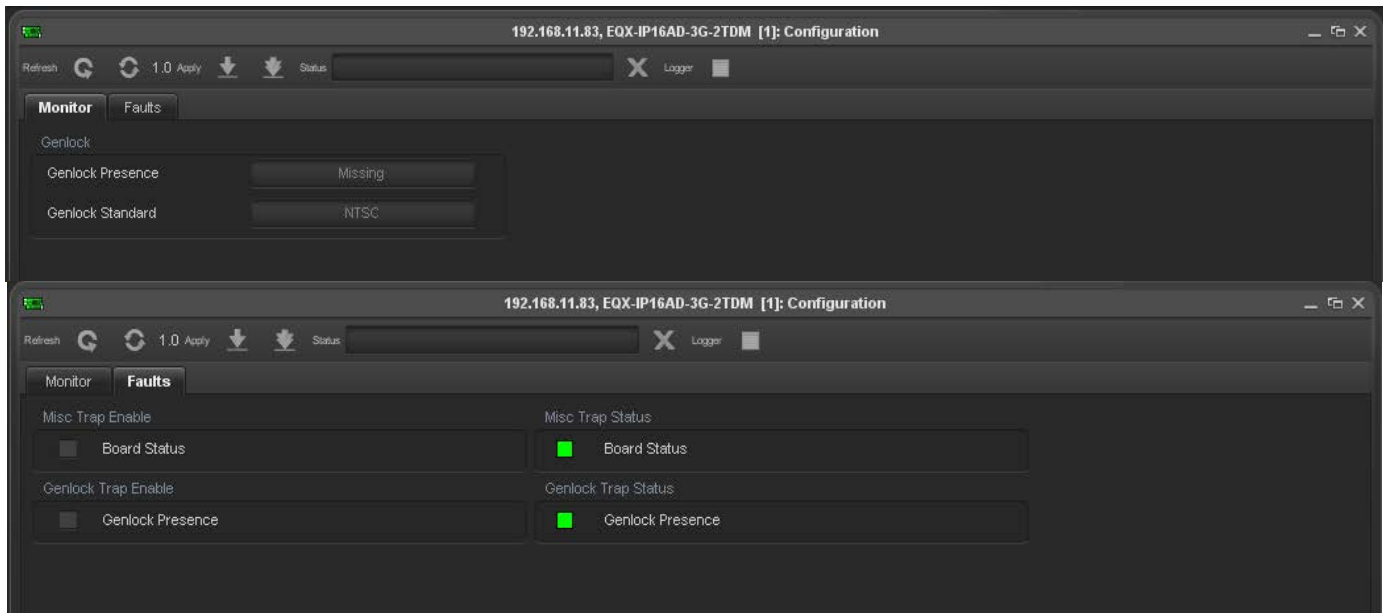

Figure 14-9 : Main Tabs for AVIP/F1 Module

Table 14-9 below provides the further details on each parameter:

Parameter	Description
Monitoring	Shows the genlock status and standard.
Faults	Set or view traps for board status and genlock presence.

Table 14-9 : Main Tabs Description for AVIP/F1 Module

14.4.2 Tabs for Individual AVIP/F1 Input

The following figure (Figure 14-10) shows the tabs for individual input:

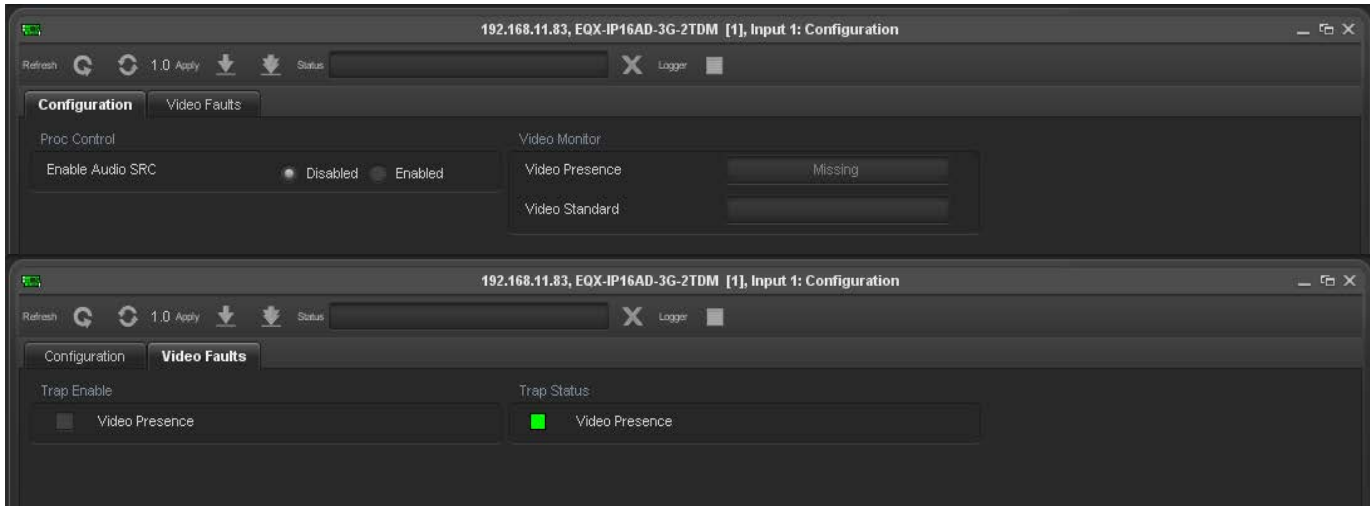

Figure 14-10 : Tabs for Individual AVIP/F1 Input

Table 14-10 below provides the further details on each parameter:

Parameter	Description
Proc Control	Enable or Disable Audio SRC (sample rate converter).
Video Monitor	Shows the video presence and standard.
Video Faults	Set or view trap for video presence.

Table 14-10 : Tabs for Individual AVIP/F1 Input Description

14.5 VISTALINK® REMOTE MONITORING/CONTROL FOR EQX-IP18-3G-F1

14.5.1 Main Tabs for EQX-IP18-3G-F1 Module

The following figure (Figure 14-11) shows the main tabs for fiber input:

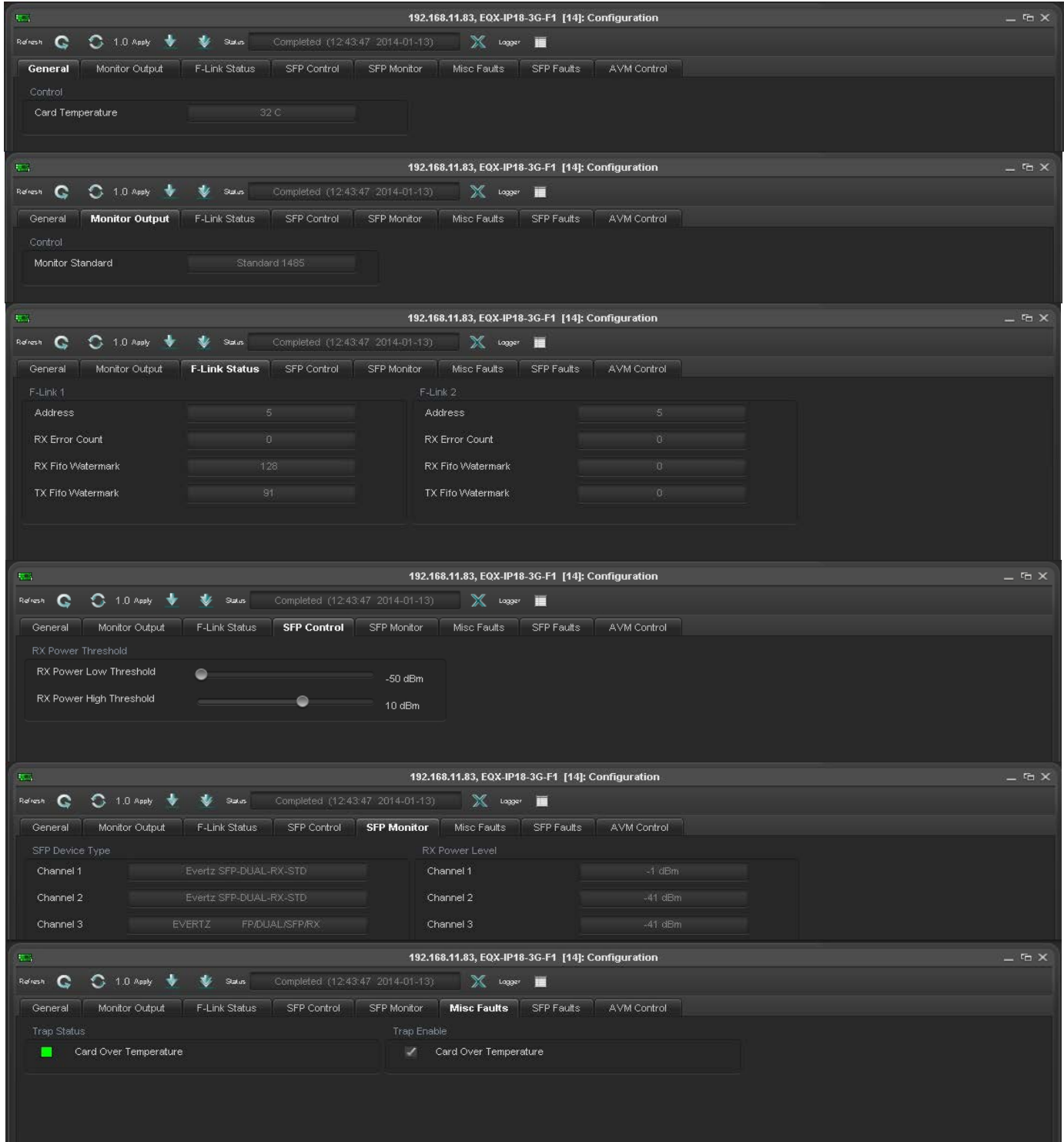

Figure 14-11 : Main Tabs for EQX-IP18-3G-F1 Module (1)

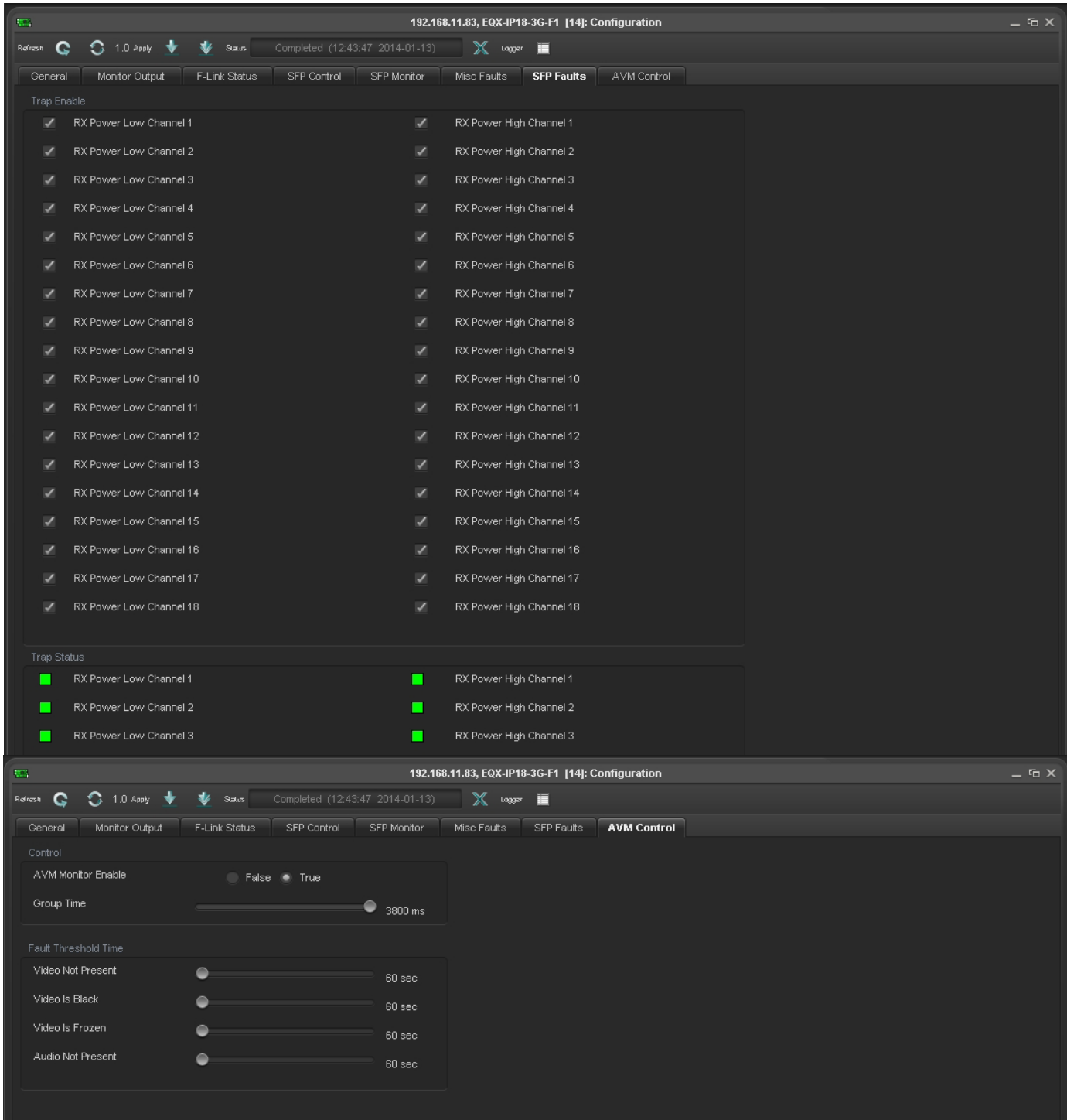

Figure 14-12 : Main Tabs for EQX-IP18-3G-F1 Module (2)

Table 14-11 below provides the further details on each parameter:

Parameter	Description
General	Shows module temperature.

Monitor Output	Shows monitor output standard.
F-Link Status	Shows main and redundant F-Link status.
SFP Control	Sets RX High and Low threshold.
SFP Monitor	Show SFP type and power level.
Misc Fault	Set or view trap for module over temperature.
SFP Fault	Set or view traps for RX high or low power.
AVM Control	Enable or disable AVM monitoring. Set the threshold time for frozen, black or missing video and Audio.

Table 14-11 : Main Tabs Description for Main Tabs for EQX-IP18-3G-F1 Module

14.5.2 Tabs for individual Fiber Input

The following figure (Figure 14-13) shows the tabs for individual Fiber input:

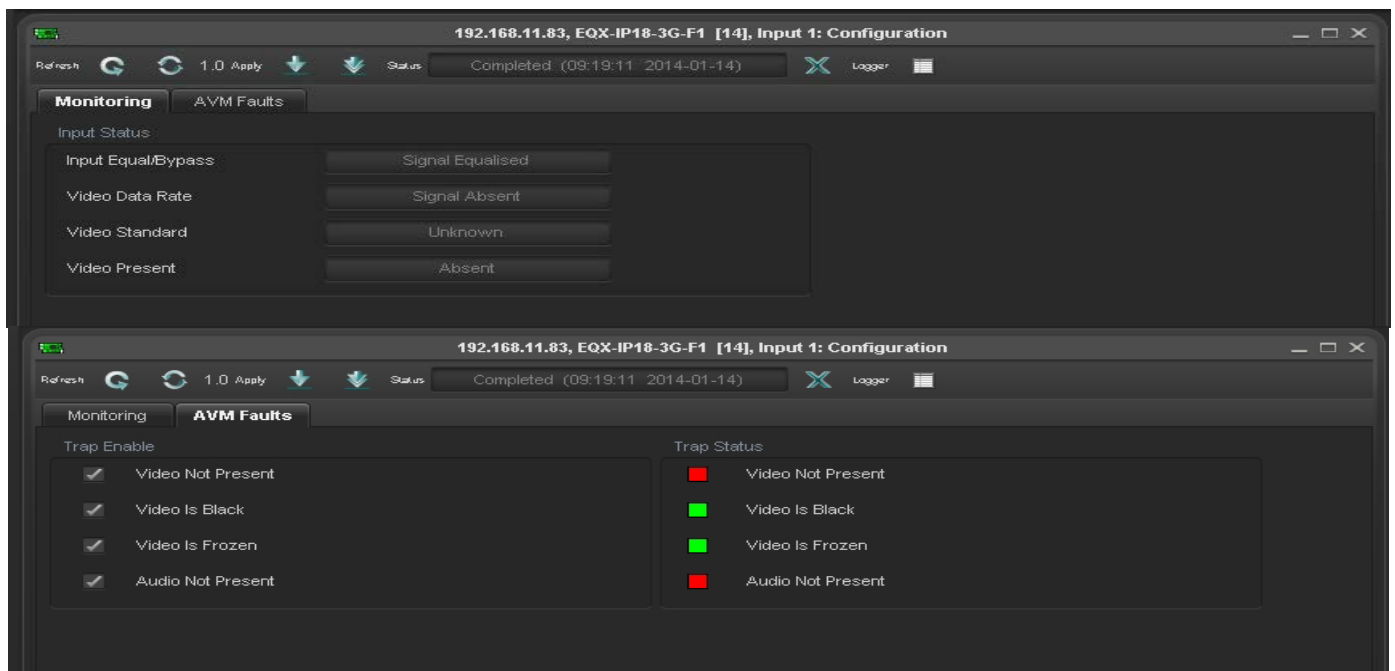

Figure 14-13 : Tabs for Individual Fiber Input

Table 14-12 below provides the further details on each parameter:

Parameter	Description
Monitoring	Shows whether the input is equalized or bypassed. Displays the video status.
AVM Faults	Set or view traps for black, Frozen or missing video and missing audio.

Table 14-12 : Tabs for Individual Fiber Input Description

14.6 VISTALINK® REMOTE MONITORING/CONTROL FOR EQX-IP18AD-3G-2TDM

14.6.1 Main Tabs for EQX-IP18AD-3G-2TDM Module

The following figure (Figure 14-14) shows the main tabs for input:

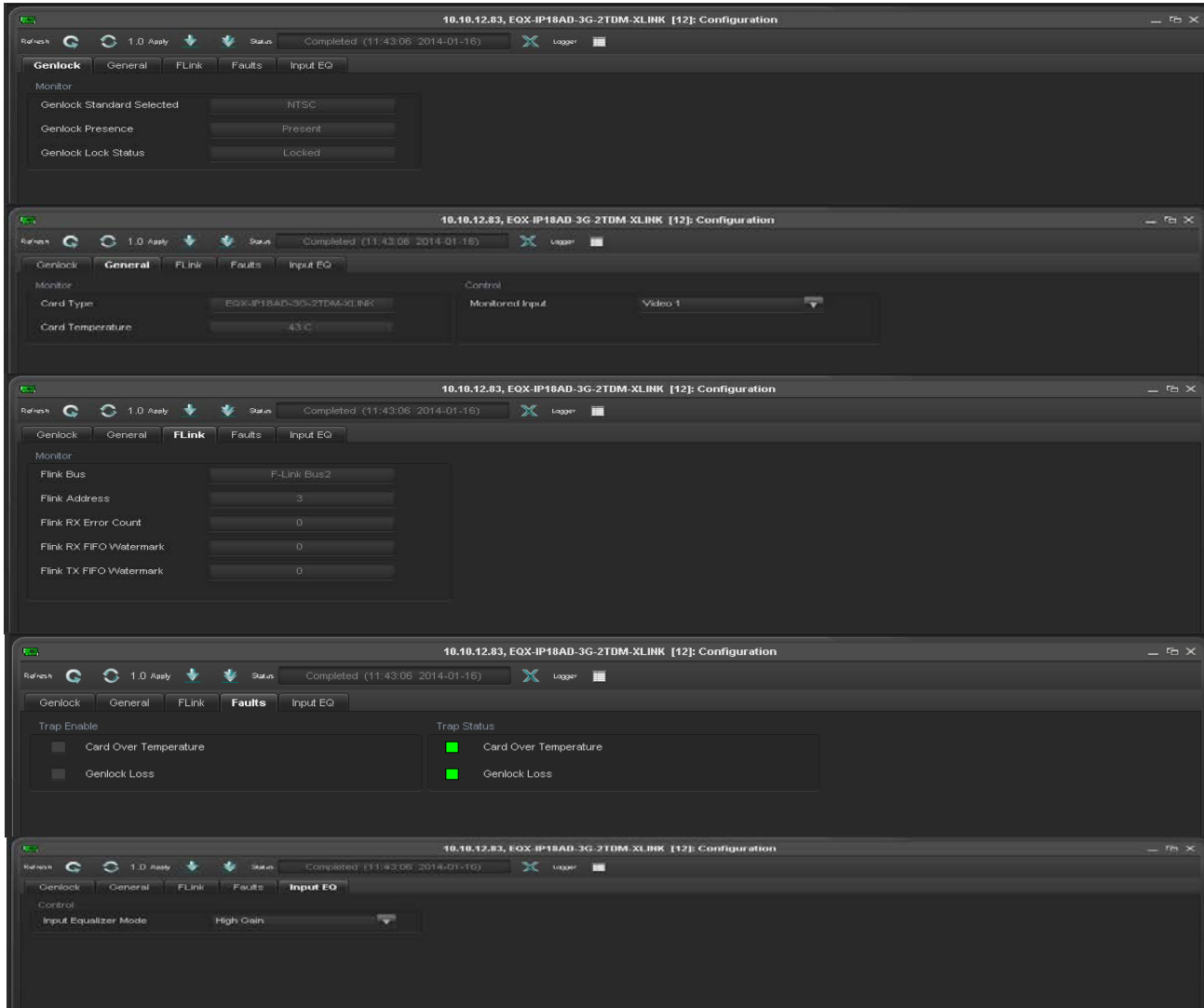

Figure 14-14 : Main Tabs for EQX-IP18AD-3G-2TDM Module

Table 14-13 below provides the further details on each parameter:

Parameter	Description
Genlock	Shows Genlock Standard, Presence and Status.
General	Shows the module type and temperature. Sets the source for monitoring.
FLink	Shows the Flink bus, address and RX and TX status.
Faults	Set or view module over temperature and Genlock loss.
Input EQ	Set input equalizer to High Gain or normal.

Table 14-13 : Main Tabs Description for EQX-IP18AD-3G-2TDM Module

14.6.2 Tabs for Individual Input

The following figure (Figure 14-15) shows the tabs for individual input:

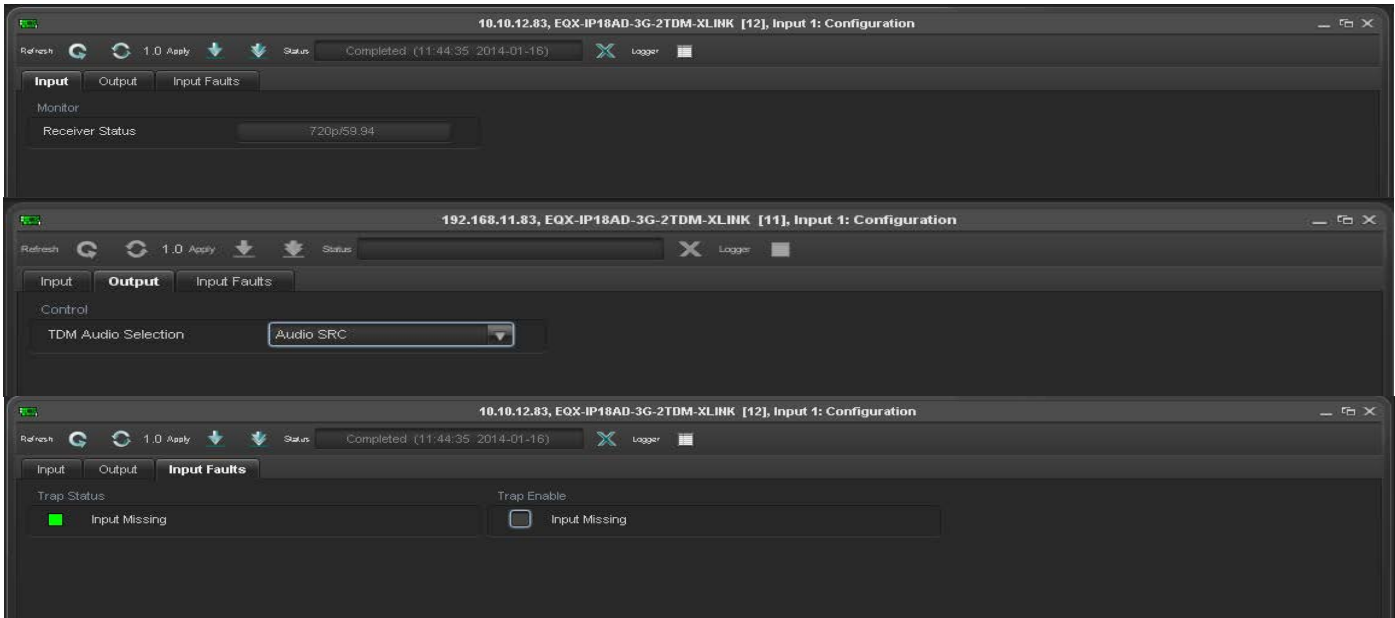

Figure 14-15 : Tabs for Individual Input for EQX-IP18AD-3G-2TDM Module

Table 14-14 below provides the further details on each parameter:

Parameter	Description
Input	Shows input standard.
Output	Set audio selection to Pass through or SRC.
Input Faults	Set or view trap for input missing.

Table 14-14 : Tabs for Individual Input Description for EQX-IP18AD-3G-2TDM Module

14.7 VISTALINK® REMOTE MONITORING/CONTROL FOR EQX-IP18FSAD-3G-2TDM

14.7.1 Main Tabs for EQX-IP18FSAD-3G Module

The following figure (Figure 14-16) shows the main tabs for input:

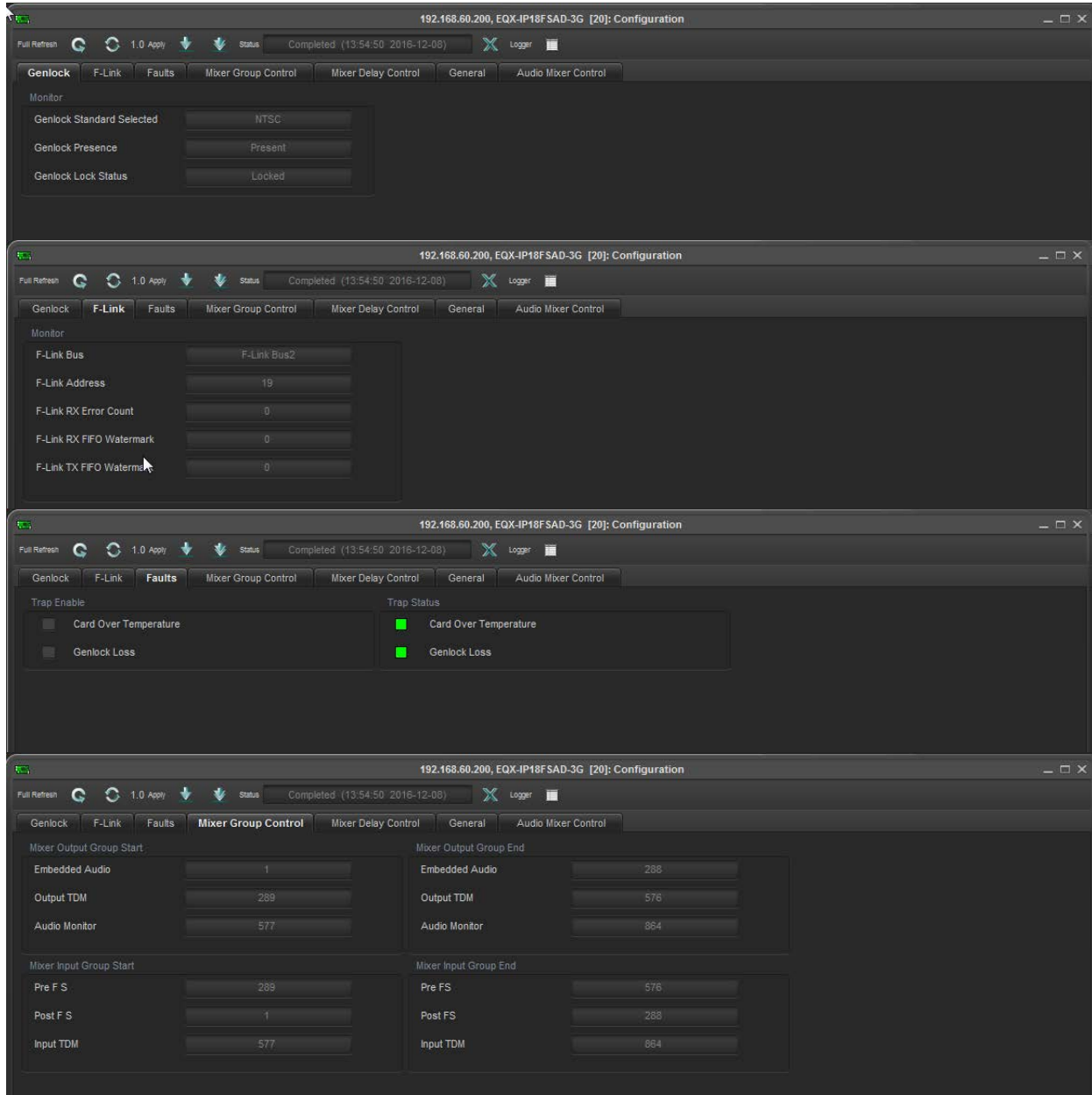

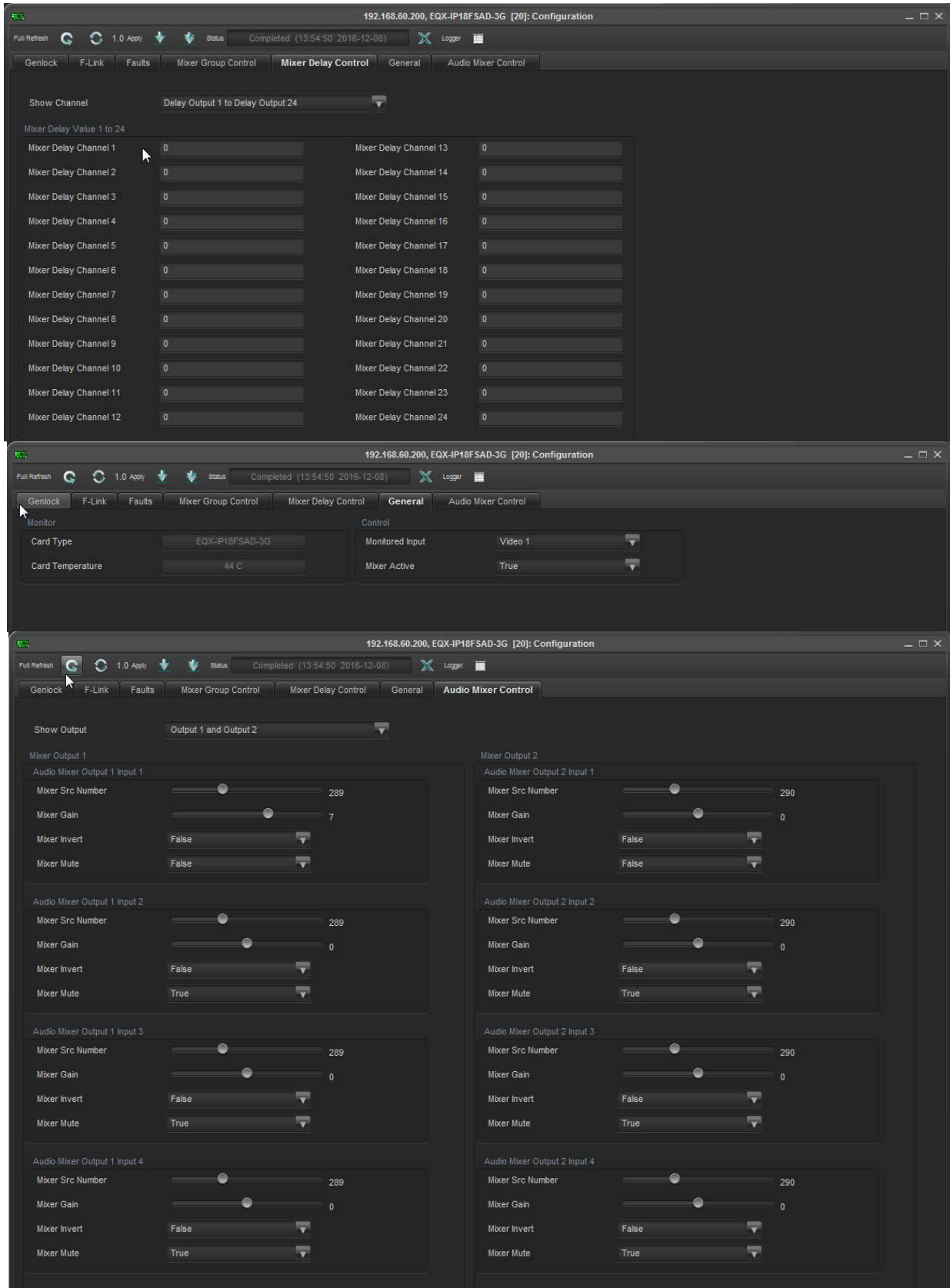

Figure 14-16 : Main Tabs for EQX-IP18FSAD-3G Module

Table 14-15 below provides the further details on each parameter:

Parameter	Description
Genlock	Shows Genlock Standard, Presence and Status.
FLink	Shows the Flink bus, address and RX and TX status.
Faults	Set or view module over temperature and Genlock loss.
Mixer Group Control	Shows the Audio Input and Output ranges that are available for audio mixer
Mixer Delay Control	Sets audio delay for outputs 1-288
General	Shows the module type and temperature. Sets the source for monitoring. Enables or disables DSP and mixer option.
Audio Mixer Control	Sets Gain, Invert, Mute and audio mixing.

Table 14-15 : Main Tabs Description for EQX-IP18FSAD-3G Module

14.7.2 Tabs for Individual Input

The following figure (Figure 14-17) shows the tabs for individual input:

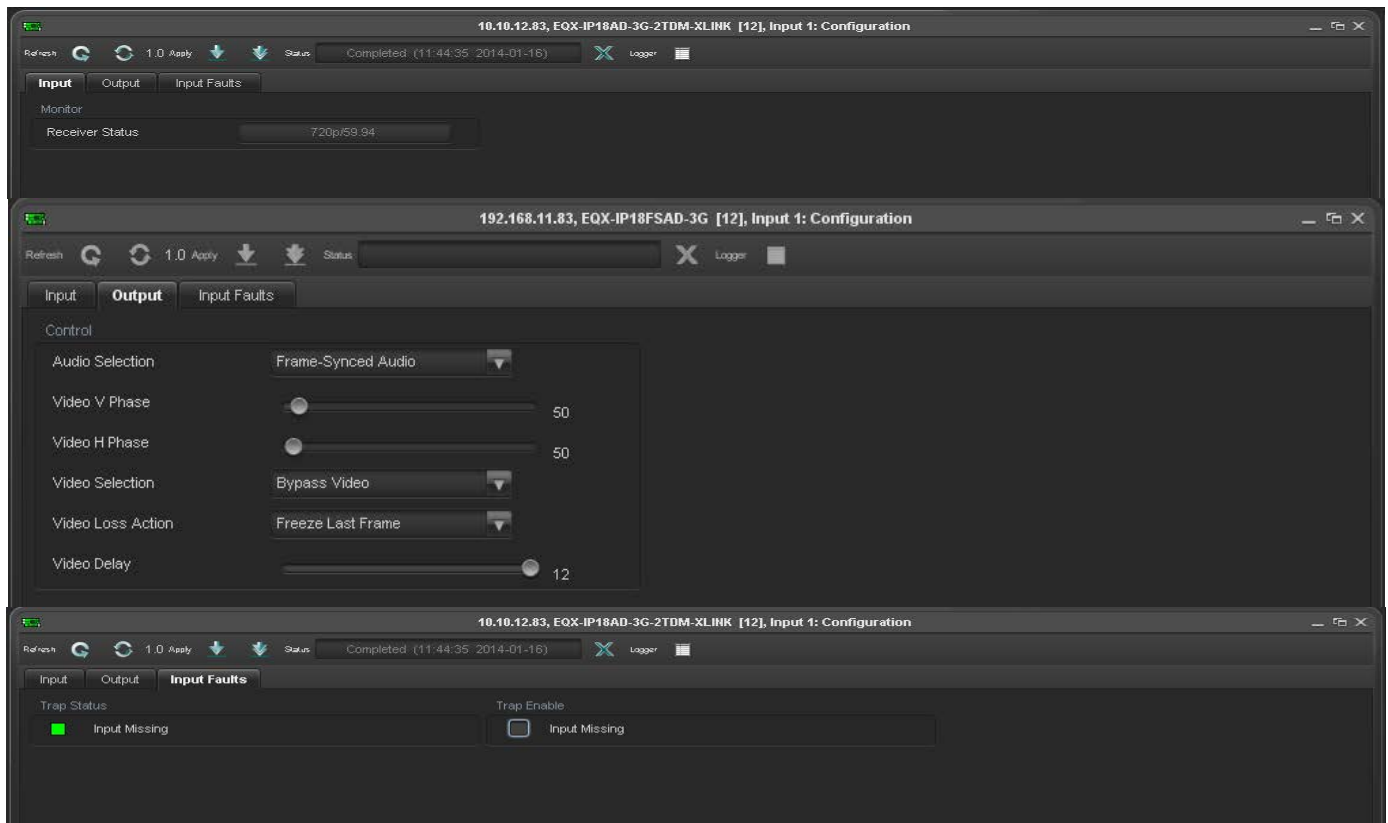

Figure 14-17 : Tabs for Individual Input for EQX-IP18FSAD-3G Module

Table 14-16 below provides the further details on each parameter:

Parameter	Description
Input	Shows input standard.
Output	Set audio to Frame-Synced, Pass through or TDM input. Set video delay, V and H offset loss action and Bypass or frame-synced video.
Input Faults	Set or view trap for input missing.

Table 14-16 : Tabs for Individual Input Description for EQX-IP18FSAD-3G Module

14.8 VISTALINK® REMOTE MONITORING/CONTROL FOR EQX-OP18-3G/EQX-G-OP18-3G

14.8.1 Main Tabs for EQX-OP18-3G/EQX-3-OP18-3G Module

The following figure (Figure 14-18) shows the main tabs for EQX output:

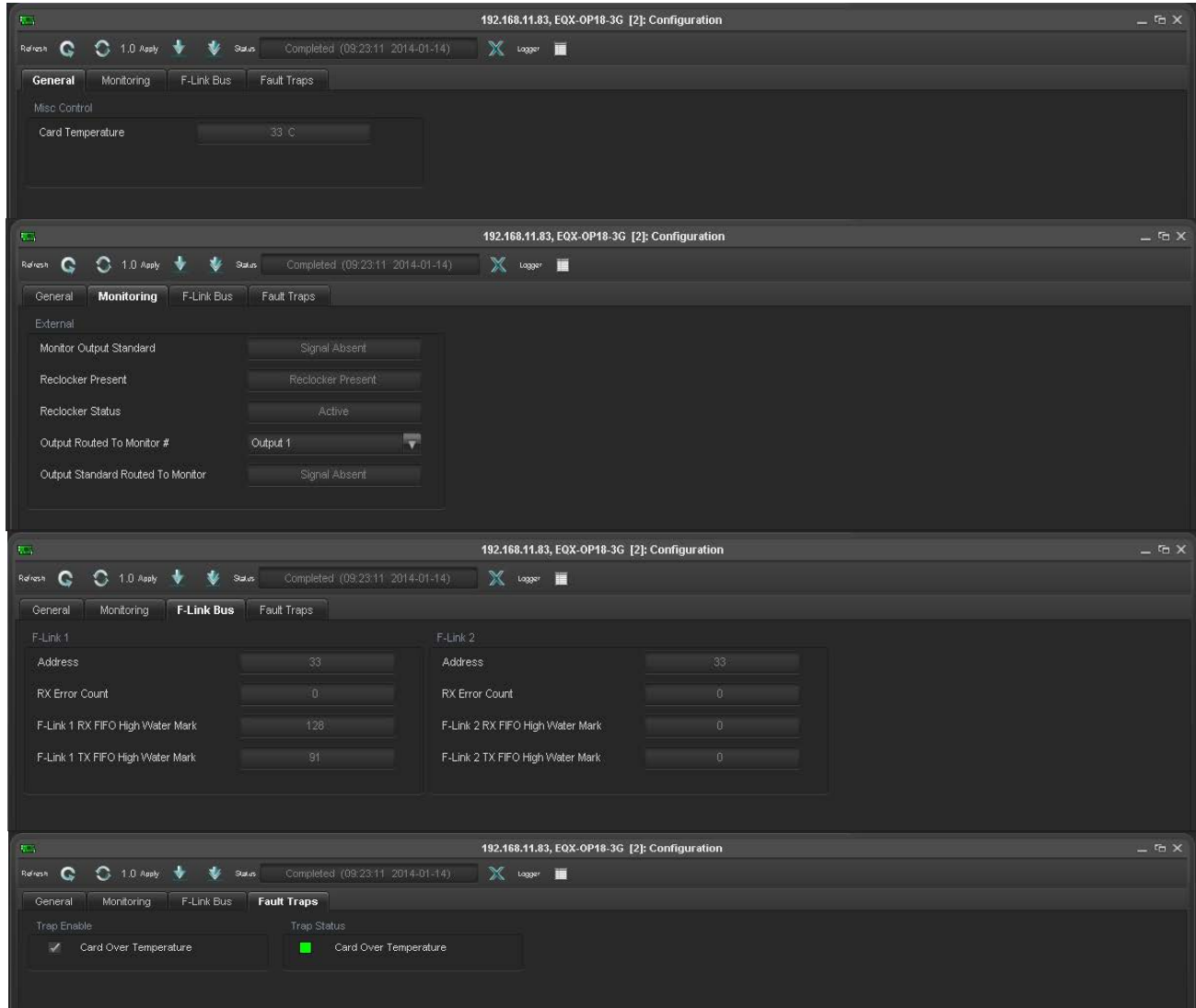

Figure 14-18 : Main Tabs for EQX-OP18-3G/EQX-3-OP18-3G Module

Table 14-17 below provides the further details on each parameter:

Parameter	Description
General	Shows the internal temperature of the module.
Monitoring	Shows signal standard, presence and status of the reclocker. Sets the monitor output source and displays the monitor output standard.
F-Link Status	Shows the Main and Redundant Flink status.
Fault Traps	Set or view trap for module over temperature.

Table 14-17 : Main Tabs Description for EQX-OP18-3G/EQX-3-OP18-3G Module

14.8.2 Tabs for Individual Output

The following figure (Figure 14-9) shows the tabs for individual output:

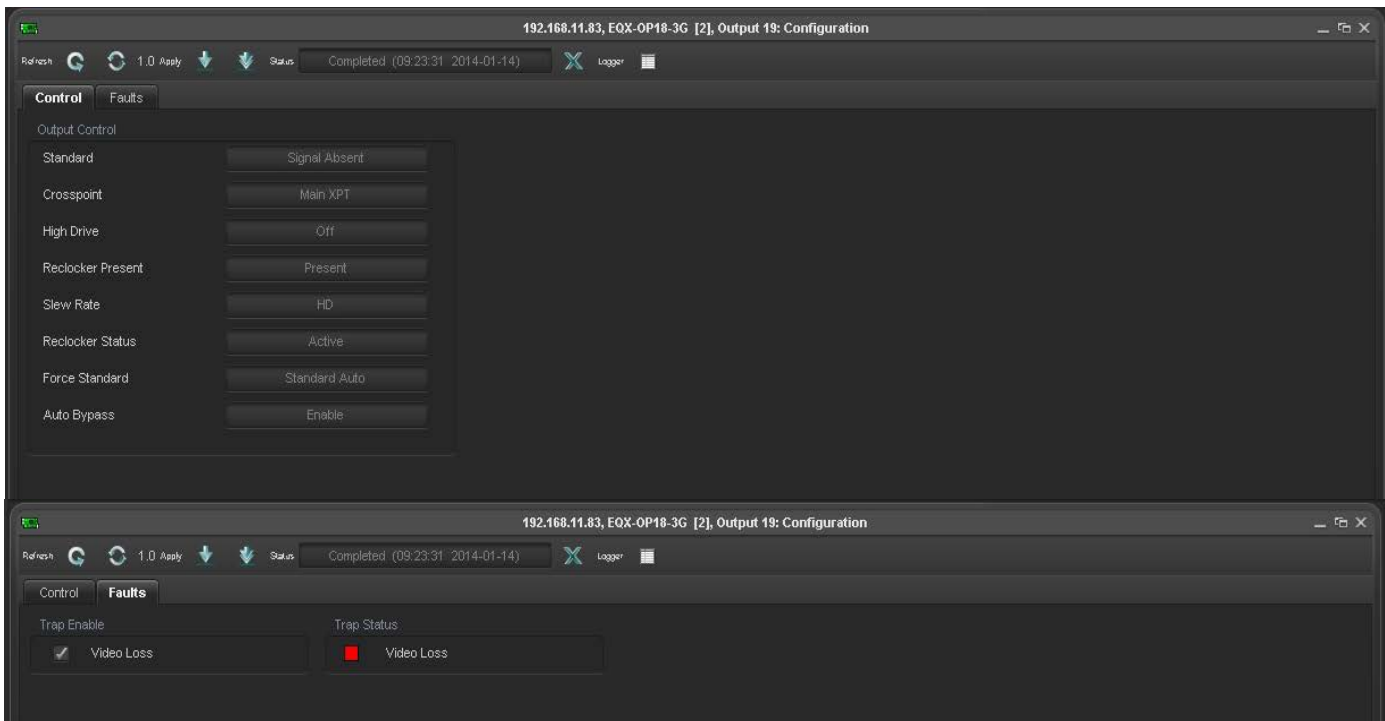

Figure 14-19 : Tabs for Individual Output

The following table (Table 14-18) provides further details on each parameter.

Parameter	Description
General Control	Shows the status for output standard, incoming signal, HD, Reclocker, Slew Rate, force standard and auto bypass.
Faults	Set or view trap for video loss.

Table 14-18 : Tabs for Individual Output Description

14.9 VISTALINK[®] REMOTE MONITORING/CONTROL FOR EQX-OP16AE-3G/F1

14.9.1 Main Tabs for EQX-AVOP/F1

The following figure (Figure 14-20) shows the main tabs for EQX-AVOP/F1:

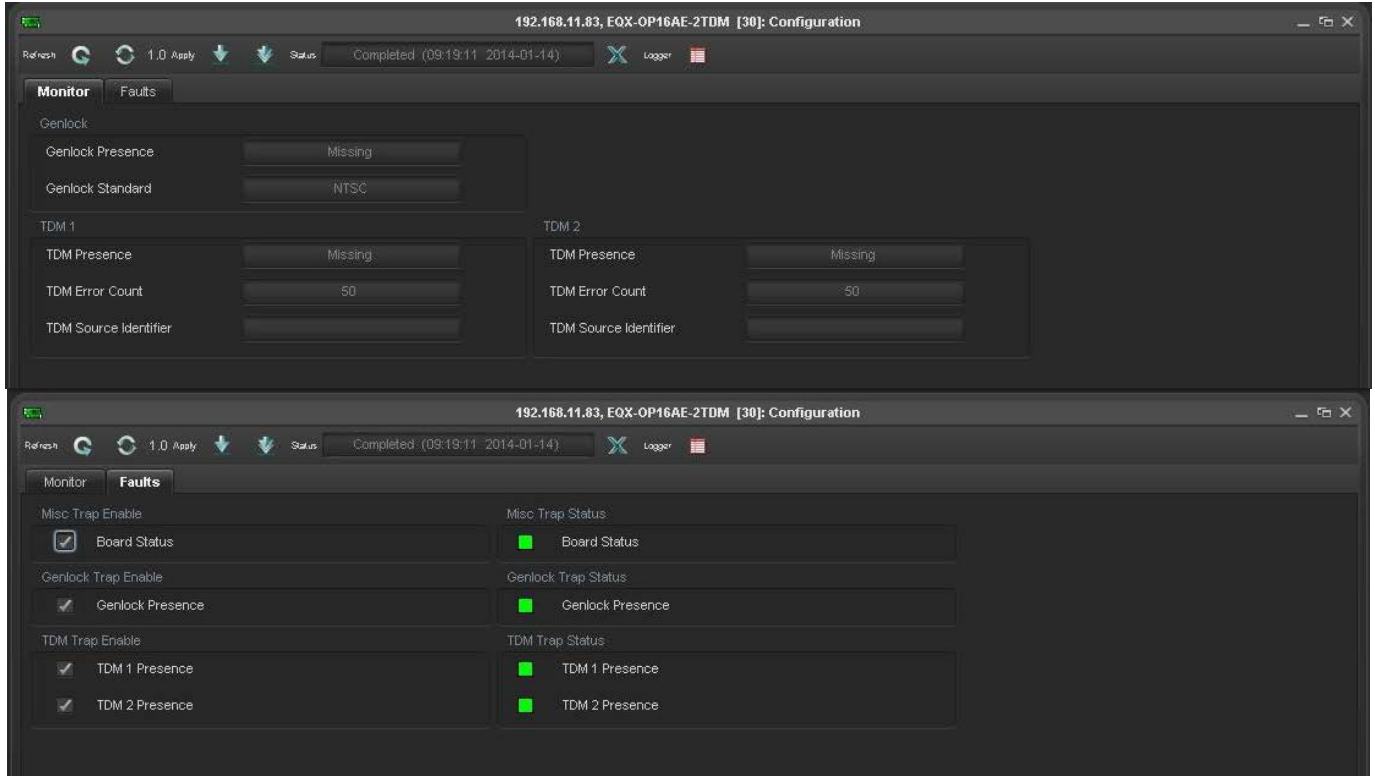

Figure 14-20 : Main Tabs for EQX-AVOP/F1

The following table (Table 14-19) provides the further details on each parameter for EQX-AVOP/F1.

Parameter	Description
Monitoring	Shows the genlock status and standard, TDM1 and 2 presences, error and identifier.
Faults	Set or view traps for board status, genlock and TDM1&2 presences.

Table 14-19 : Main Tabs Description for EQX-AVOP/F1

14.9.2 Tabs for Individual EQX-AVOP/F1 Output

The following figure (Figure 14-21) shows the individual tabs for EQX-AVOP/F1 outputs:

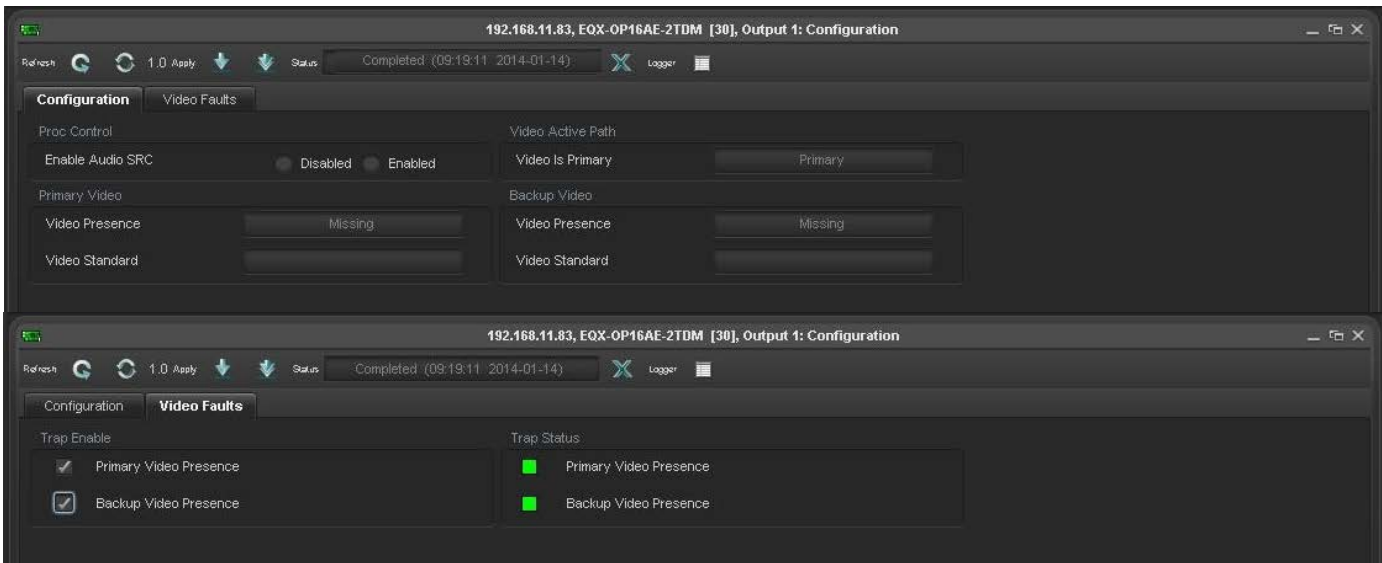

Figure 14-21 : Tabs for Individual EQX-AVOP/F1 Output

Table 14-20 below provides the further details on each parameter.

Parameter	Description
Proc Control	Enable or Disable Audio SRC (sample rate converter).
Video Monitor	Shows the video active path, video presence and standard for primary and secondary path.
Video Faults	Set or view trap for primary and backup video presence.

Table 14-20 : Tabs for Individual Description for EQX-AVOP/F1 Output

14.10 VISTALINK[®] REMOTE MONITORING/CONTROL FOR EQX-OP18-3G-F1

14.10.1 Main Tabs for EQX-OP18-3G-F1 Module

The following figure (Figure 14-22) shows the main tabs for fiber output:

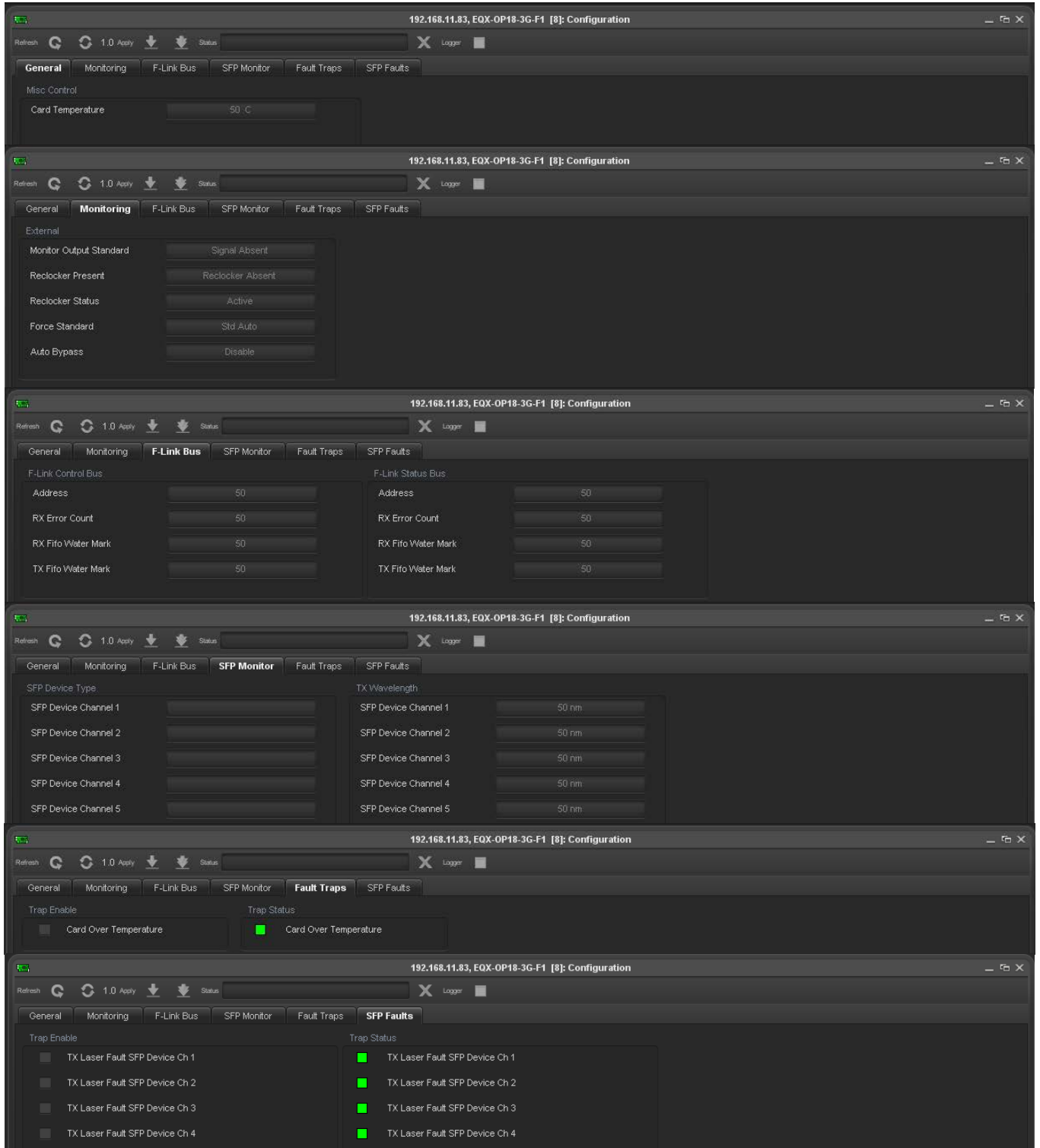

Figure 14-22 : Main Tabs for EQX-OP18-3G-F1 Module

Table 14-21 below provides the further details on each parameter:

Parameter	Description
General	Shows the internal temperature of the module.
Monitoring	Shows signal standard, presence and status of the reclocker. Sets the monitor output source and displays the monitor output standard.
F-Link Status	Shows main and redundant F-Link status.
SFP Monitor	Show SFP type and TX Wavelength.
Fault Traps	Set or view trap for module over temperature.
SFP Fault	Set or view traps for TX leaser fault.

Table 14-21 : Main Tabs Description for EQX-OP18-3G-F1 Module

14.10.2 Tabs for Individual Fiber Output

The following figure (Figure 14-23) shows the tabs for individual Fiber output:

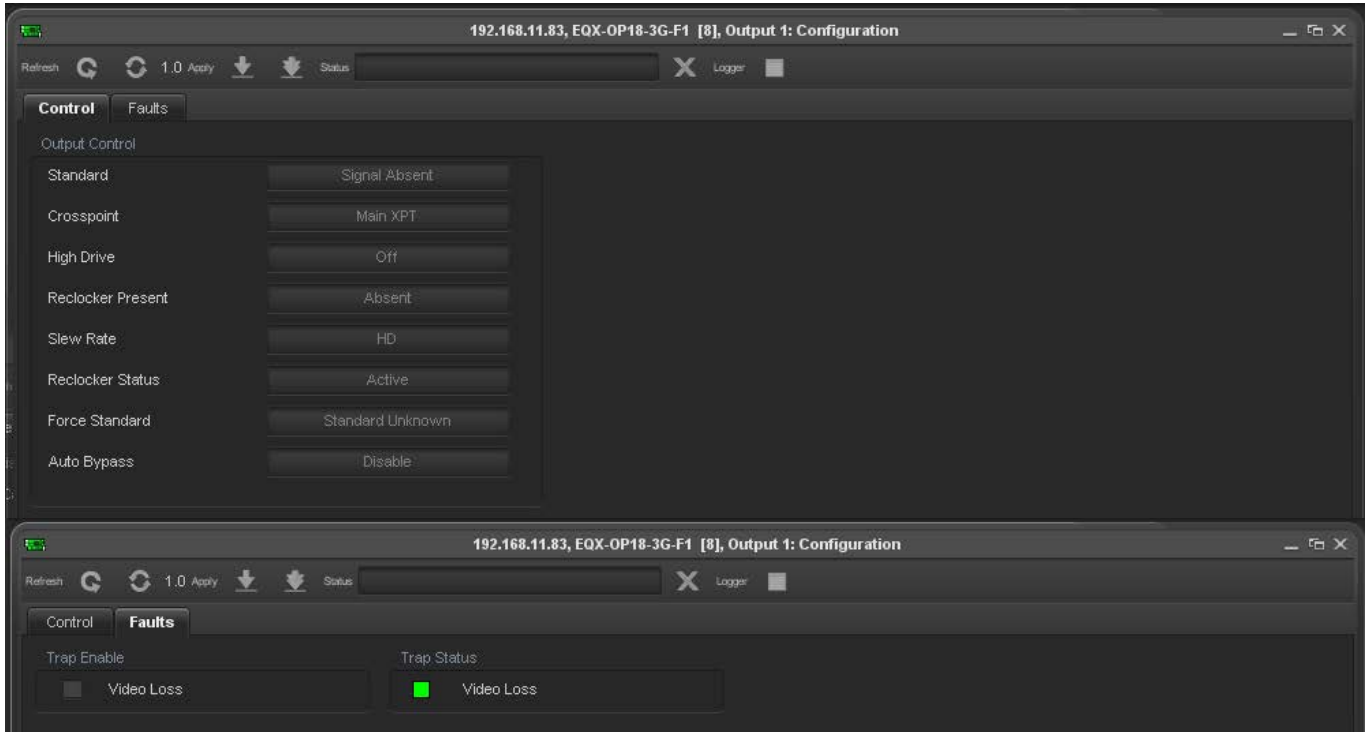

Figure 14-23 : Tabs for Individual Fiber Output

Table 14-22 below provides the further details on each parameter:

Parameter	Description
Control	Shows signal presence, XPT path, Reclocker standard and presence, Slew Rate, Auto Bypass and Forced standard.
Faults	Set or view traps for video loss.

Table 14-22 : Tabs for Individual Fiber Output Description

15 APPENDIX A - VIDEO REDUNDANT PATH MONITORING

There are different methods for checking if a route path is on main or redundant.

1. Checking the Output modules' Status LEDs

- Output modules' Status LEDs indicate if an output is on Main or Redundant path.
- If LEDs are Solid, it means the outputs are on the Main path.
- If one or more LEDs are flashing, it means those outputs are on Redundant Path.



Note: In an EQX-OP36-3G-XIO module the top 18(1-18) status LEDs are valid, the bottom 18 (19-36) status LEDs are not valid.

2. Using Engineering Panel in Winsetup

- In Winsetup under “system” menu click on “Engineering Panel”
- To check if an output is on main or redundant path, select that destination from drop down menu under “Current Destination”.
- The status of the output will be displayed under “Level Status Window”. Shown in Figure 15-1 below:

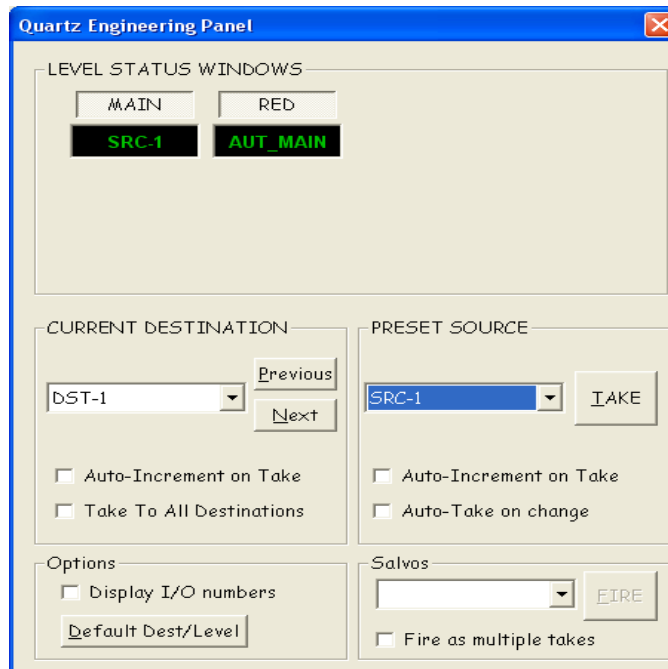

Figure 15-1 : Level Status Window

- In the above picture, source 1 is routed to Destination 1 and it is on the main path.

3. Using Quartz Commands:

- Open the comms window in Winsetup.
- Click on “Acknowledgement” button a couple of times and make sure “.A” is coming back in response.
- Inside comms window type “.IA[DST] [Press Enter]“ or for a range of destinations type “.IA [DST-DST] [Press Enter]. Shown in Figure 15-2.
 - .IA25
 - .AA025,580 (output 25 is on Auto Main Path)
 - .IA1-4
 - .AA001,580 (output 1 is on Auto Main Path)
 - .AA002,580 (output 2 is on Auto Main Path)
 - .AA003,581 (output 3 is on Auto Redundant Path)
 - .AA004,581 (output 4 is on Auto Redundant Path)

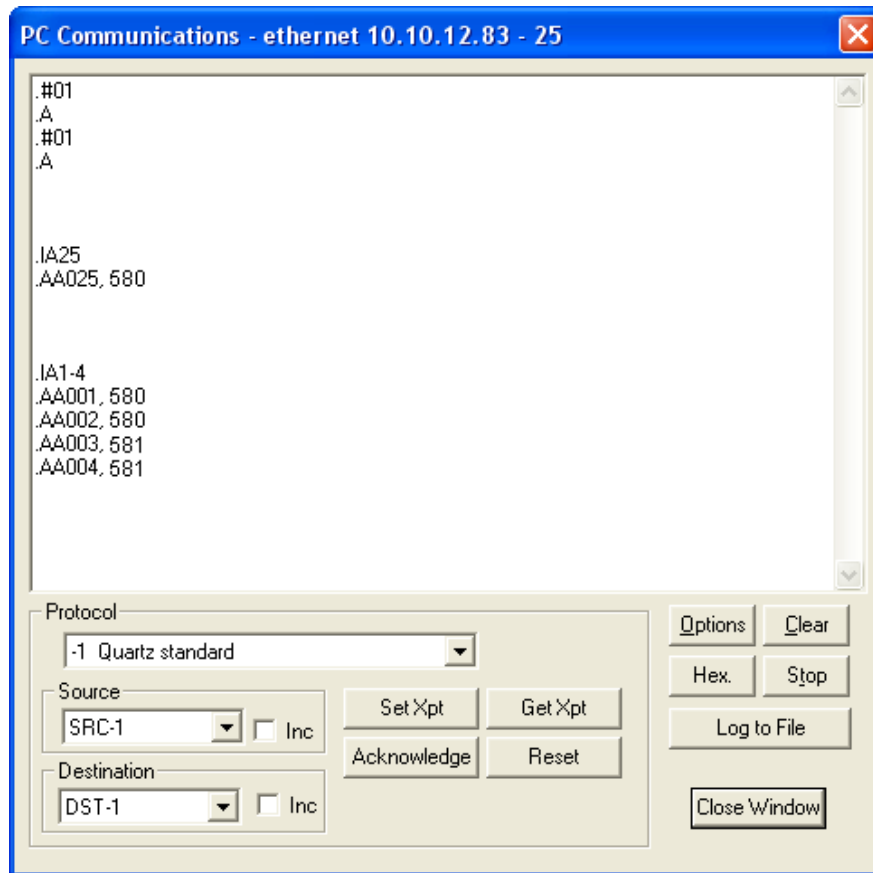
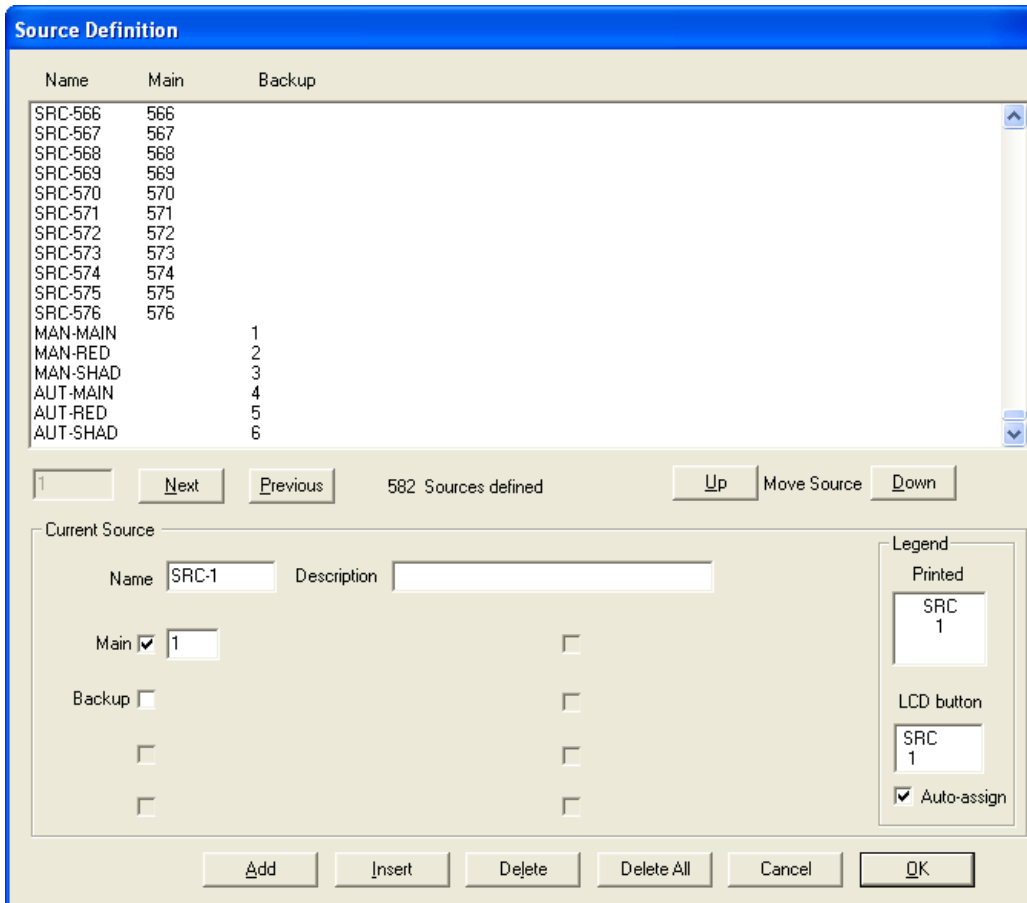

Figure 15-2 : PC Comms Window in WinSetup



Note: Different Systems have different main and redundant sources assigned; it all depends on the config file. Figure 15-3 shows the sources table for a 576X576 system.



Name	Main	Backup
SRC-566	566	
SRC-567	567	
SRC-568	568	
SRC-569	569	
SRC-570	570	
SRC-571	571	
SRC-572	572	
SRC-573	573	
SRC-574	574	
SRC-575	575	
SRC-576	576	
MAN-MAIN		1
MAN-RED		2
MAN-SHAD		3
AUT-MAIN		4
AUT-RED		5
AUT-SHAD		6

1 Next Previous 582 Sources defined Up Move Source Down

Current Source

Name: SRC-1 Description:

Main: 1

Backup:

Legend

Printed

SRC 1

LCD button

SRC 1

Auto-assign

Add Insert Delete Delete All Cancel OK

Figure 15-3 : Source Definition

Descriptions for the Sources on Level A (RED) are described in Appendix A:

577 is Manual Main
 578 is Manual Redundant
 580 is Auto Main
 581 is Auto Redundant

4. By using Telnet or Serial port:

- FC config menu can be accessed either by telnet or Serial port, connected to the FC's module edge four pin connector.
- Under "Main Menu" select option 4 (Monitor and Control) and then option 14 (Show FC redundancy table), in that table it will show if the Outputs are on main or redundant path. Shown in Figure 15-4.

In Figure 15-4 Output one is on AR (Auto Redundant)

- AM: Auto Main
- AR : Auto Redundant
- MM: Manual Main
- MR: Manual Redundant

```

<X> Exit
> 4
-----
Monitor and Control
<EQX-FC v3.00 et.10839>
-----
<1> Show fan speeds
<2> Show fan temperatures
<3> Show voltages
<4> Show card temperatures
<5> Fan Speed Control
<6> XPT Fan Speed Control
<7> Show alarm settings
<8> Show network switch status
<9> Show input standards
<10> Show output standards
<11> Show main xpt output standards
<12> Show redundant xpt output standards
<13> Show FC route table
<14> Show FC redundancy table
<15> Show FC lock table
<16> Show FC active config settings
<17> Broadcom Temperatures
<18> Broadcom Ports
<19> Broadcom MAC Table
<20> Switch MIBs
<21> Show FC net scan table
<22> Show multi-master stats
<23> Video path self test
<X> Exit
> 14
Output 1 2 3 4 5 6 7 8 9 10 11 12 13 14 15 16 17 18
0001: AR AM AM AM AM AM AM AM AM AM AM AM AM AM AM AM AM AM AM
0019: AM AM AM AM AM AM AM AM AM AM AM AM AM AM AM AM AM AM AM
0037: AM AM AM AM AM AM AM AM AM AM AM AM AM AM AM AM AM AM AM
0055: AM AM AM AM AM AM AM AM AM AM AM AM AM AM AM AM AM AM AM
0073: AM AM AM AM AM AM AM AM AM AM AM AM AM AM AM AM AM AM AM
0091: AM AM AM AM AM AM AM AM AM AM AM AM AM AM AM AM AM AM AM
0109: AM AM AM AM AM AM AM AM AM AM AM AM AM AM AM AM AM AM AM
0127: AM AM AM AM AM AM AM AM AM AM AM AM AM AM AM AM AM AM AM
0145: AM AM AM AM AM AM AM AM AM AM AM AM AM AM AM AM AM AM AM
0163: AM AM AM AM AM AM AM AM AM AM AM AM AM AM AM AM AM AM AM
    
```

Figure 15-4 : FC Config Menu

5. By checking In VistaLINK Pro:

- Open EQX-FC config in VLPRO
- Under XPT Redundancy tab, the second column shows whether the output is on main or redundant path. Shown in Figure 15-5:

Redundancy Output No.	XPT Active	XPT Redundancy Mode
1	Main XPT	Automatic Control
2	Main XPT	Automatic Control
3	Main XPT	Automatic Control
4	Main XPT	Automatic Control
5	Main XPT	Automatic Control
6	Main XPT	Automatic Control
7	Main XPT	Automatic Control
8	Main XPT	Automatic Control
9	Main XPT	Automatic Control
10	Main XPT	Automatic Control
11	Main XPT	Automatic Control
12	Main XPT	Automatic Control
13	Main XPT	Automatic Control
14	Main XPT	Automatic Control
15	Main XPT	Automatic Control
16	Main XPT	Automatic Control
17	Main XPT	Automatic Control
18	Main XPT	Automatic Control

Figure 15-5 : EQX-FC Config in VLPRO

This page left intentionally blank

16 APPENDIX B - REDUNDANCY MODES

There are 6 virtual sources that are hard coded to the redundant level as defined in the config files. They are always in the following order.

1. **Manual Main (MM):** (The path for the output is from the main XPT and will not auto fail to the redundant path upon path failure)
2. **Manual Redundant (MR):** (The path for the output is from the redundant XPT and will not change under any circumstance)
3. **Manual Shadow (MS):** (Never USE This Option)(main and redundant paths for an output are following each other as routes are done – R&D debug feature)
4. **Automatic Main (AM):** (The path for the output is from the main XPT and will automatically failover upon main XPT path failure, if the redundant path is not already used by a shared output and is good.)
5. **Automatic Redundant (AR):** (The path for the output is from redundant XPT. When the output is on Auto-Redundant this would represent a path failure on the Main path for the given output. The ONLY times that output will switch from Auto-Redundant back to Auto-Main is by switching it manually or if the redundant path is shared by a failed destination which has a higher redundancy priority set. This would release the redundant path for use by the more important output. Redundancy priorities can be set as exceptions in WinSetup.)
6. **Automatic Shadow (AS):** (The router enters auto shadow mode on a destination when a DST is in Auto-Main mode and a path failure is detected on the main path. This is where the decision making is done.)



Note: Always keep the routes to AM and never try to force any routes to redundant unless you are told by Evertz Engineers.

Example:

DST 99 main path fails:

- a. The output module reports a loss of video on DST-99
- b. The FC checks that the routed input is still present (if SRC is NOT present stay on main path)(If SRC is present go to step c)
- c. The FC initiates Auto-Shadow mode which routes the redundant path to the same SRC which is routed on the main path.
- d. You get an update .UA99,582
- e. The output module now compares the Main path to the Redundant path to decide if the redundant path is better.

- f. From the video standards information reported from the output module to the FC, FC now makes a decision.
- Main path good + Redundant path good = stay on Main path (.UA99,580)
 - Main path bad + Redundant path good = switch to redundant (.UA99,581)
 - Main path bad + Redundant path bad = stay in shadow mode and wait for a path to become good.

17 APPENDIX C - Q-LINK – EQX CONTROL PANEL NETWORK

Q-Link is the network that interconnects the Quartz routers and the Quartz remote control panels. Q-Link is a standard 75Ω video cable that daisy-chains from frame-to-frame and panel-to-panel. The maximum distance for a Q-Link chain is 500m.



Note: Each end of the Q-Link must be terminated with a 75Ω terminator. It is also recommended that all unused Q-Link ports on the rear of the router are fitted with a 75Ω terminator.

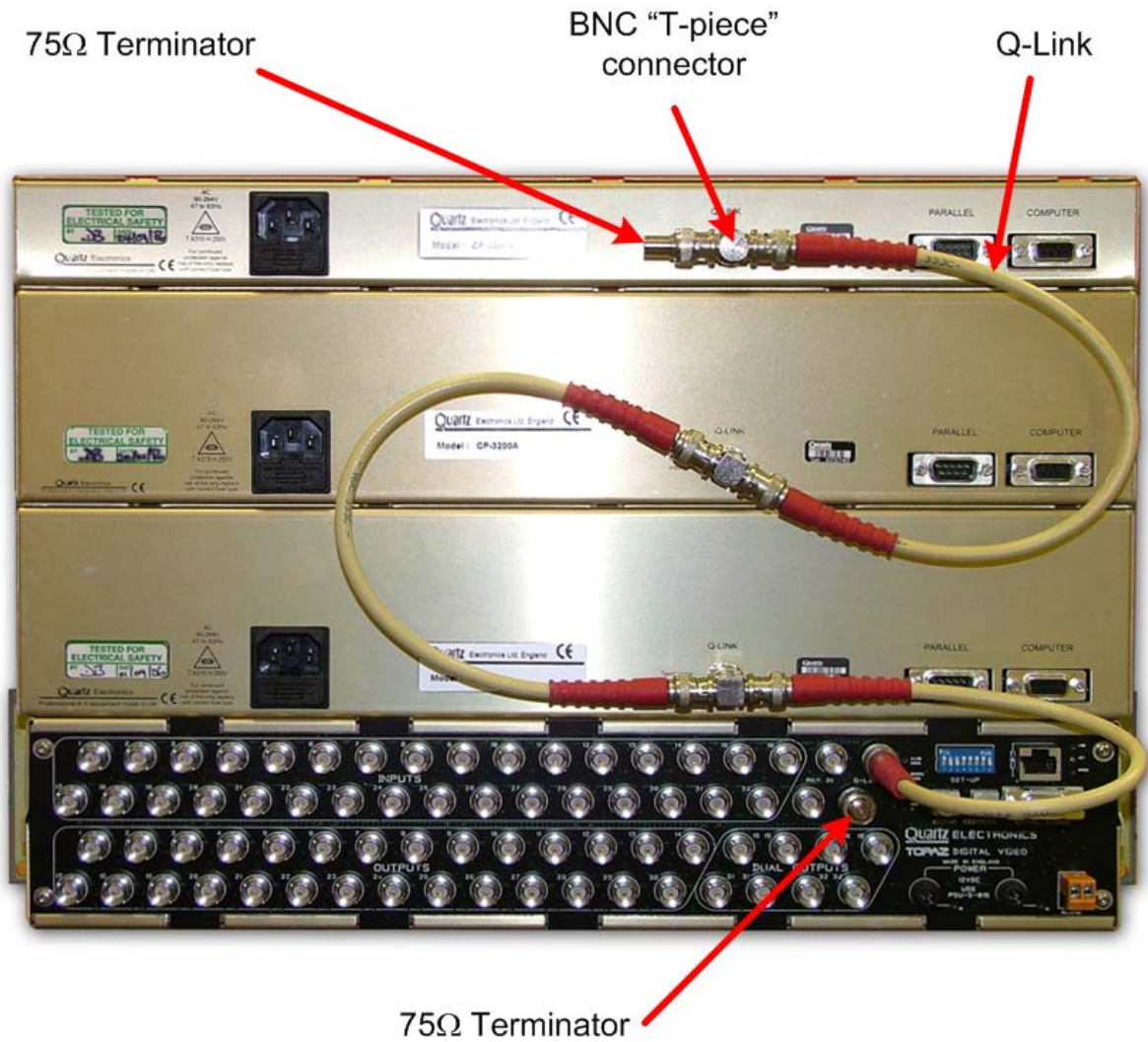

Figure 17-1 : Daisy Chain Configuration of Q-Link Panels

The standard EQX router has four (4) Q-Link ports that are internally terminated with 75Ω.

Only one Q-Link connector is fitted on the remote control panel.

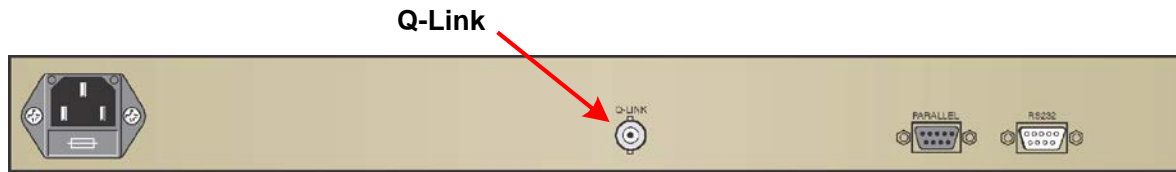

Figure 17-2 : Q-Link Connector on the remote control panel

A 'T-piece' is required to connect the control panel onto the Q-Link network.



Figure 17-3 : T-piece Connector

The “T-piece” allows any of the control panels within a Q-Link chain to be removed from service and replaced without disrupting the Q-Link.

This daisy chain method ensures the best transmission quality of the control signals down the cable. A total of 32 devices can be supported by Q-Link. This includes the router frames and remote control panels.

Each unit connected to the Q-Link, router and control panel have their own addresses, which is set via two rotary address switches in the older panels and via serial menu in the newer models.