

3505FR-64-BNC2

High Density Fiber Optic SFP BNC Frame

The Evertz 3505FR-64-BNC2 is a high-capacity bulk optical conversion platform. With the ability to accommodate 64 Evertz 3405 series SFP's, up to 128 optical to electrical or electrical to optical conversions may be performed in a single frame. Occupying only 2RU of rack space, the 3505FR-64-BNC2 is the industry's highest density optical conversion platform making it ideal for space-limited applications. The 3505FR-64-BNC2 can accommodate any 3405 series SFP, allowing the SFP cages to be populated as needed with optical transmit, receive, regenerator or electrical distribution amplifier SFP's. The SFP positions are not limited by function - any combination of 3405SFP types may be used, making countless versatile combinations possible. Benefits of fiber optics for video transport include longer attainable distances, smaller/lighter cabling, reduced cable tray loads and electrical isolation. The 3505FR-64-BNC2 provides a low-overhead means for simple electrical/optical conversion for interfacility transport, as well as overcoming the limitations imposed by coaxial cable in intra-facility applications.

3405 series SFP's are able to handle ASI, SDI, HD-SDI and 3G digital video signals, as well as other signal rates up to 3 Gig on non-reclocked versions (e.g. MADI). The SFP modules are hot-swappable, allowing for quick servicing or easy reconfiguration or expansion at any time. 16 CWDM wavelengths are also available, which when combined with Evertz CWDM products allow up to 16 signals to be multiplexed on to a single fiber, greatly conserving fiber usage.

The 3505FR-64-BNC2 supports full remote monitoring and control over SNMP/VistaLINK® when optional frame controllers are installed. The platform supports a single frame controller, or dual modules may be installed for redundancy. Numerous parameters such as optical power and electrical signal presence and rate can be accessed remotely to monitor system integrity. The 3505FR-64-BNC2 was designed to provide carrier-grade reliability with all SFP's, power supplies, frame controllers and the fan module being hot-swappable. There are no active components in the frame itself, a patent-pending feature from Evertz ensuring that the frame and coaxial cabling never need to be removed from the rack for service.



Features & Benefits

- Highest density in the industry – up to 128 conversions in 2RU
- Any combination of 3405SFP types may be installed in any slots, including optical transmit, receive, regenerator and electrical distribution amplifiers
- All active components are hot-swappable
- SFP modules can be hot-swapped without de-cabling coaxial connections
- Temperature controlled fans to minimize audible noise
- Accommodates single or dual redundant frame controllers
- Accommodates redundant power supplies
- Comprehensive signal and card status monitoring via four digit card edge display or remotely through SNMP and VistaLINK® when frame controller(s) are installed

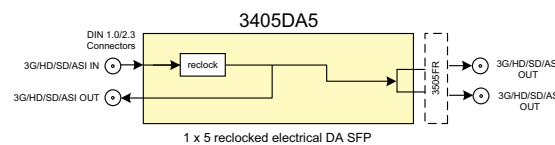
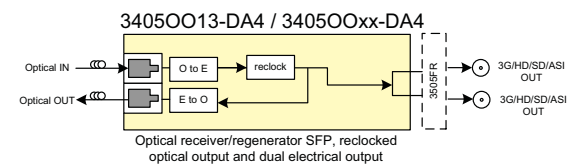
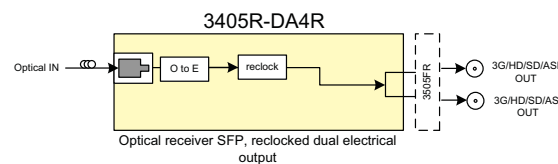
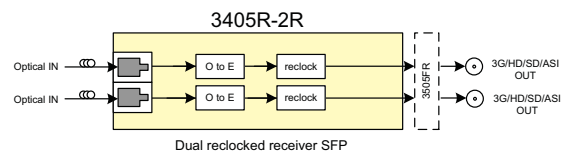
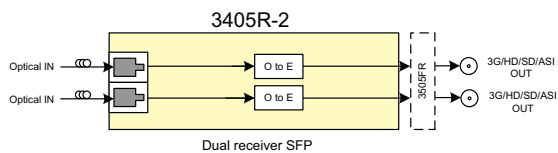
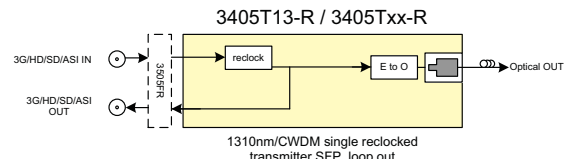
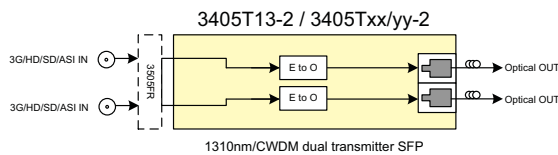

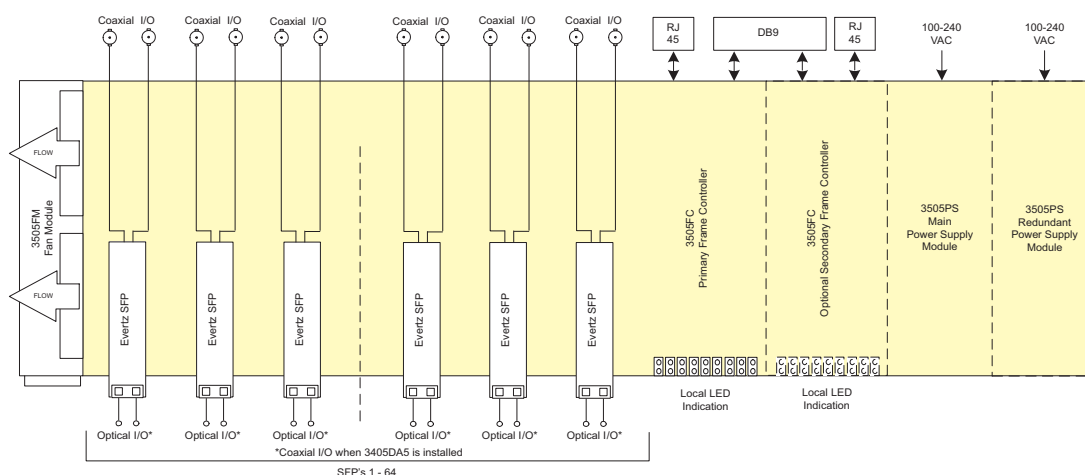

Specifications (Note: Electrical input & output specs only apply to reclocking SFP modules)

System:		Optical Input:		Electrical Outputs:	
Density:	Up to 64 EO, OE, or mixture of EO and OE in a 2RU unit	Number of Inputs:	Up to 2 per SFP	Connector:	BNC per IEC 61169-8 Annex A
Impedance:	75Ω	Connector:	LC/U/PC	Impedance:	75Ω (nominal)
Communication and Control:		Operating Wavelength:	1270nm to 1610nm	Signal Level:	800mV (nominal)
Serial:	RS-232 - single Female 9-pin D connector	Maximum Input Power:	-1dBm	DC Offset:	0V +/-0.5V
Ethernet:	SNMP over IEEE 802.3/U (10/100 BaseTx) RJ45 connector for M&C	Standard:	-1dBm	Rise and Fall Time (Reclocked SFP's only):	HD/3G: <135p
Control:	VistaLINK®/SNMP	Optical Sensitivity:	-21dBm at 2.97Gb/s pathological Level A	SD:	< 900ps
Optical Output:		Standard:	-23dBm at 2.97Gb/s color bars	Overshoot(Reclocked SFP's only)	< 10% of amplitude
Number of Outputs:	Up to 2 per SFP	Electrical Inputs:		Return Loss:	>15dB to 1.5GHz
Connector:	LC/U/PC	Reclocked Standard	SMPTE 424M (3 Gb/s), ST 292-1 (1.5Gb/s), SMPTE 259M (270Mb/s), DVB-ASI	Alignment Jitter(Reclocked SFP's only):	< 0.2UI (Reclocked) to 1.485Gb/s
Optical Power:		Connector:	BNC Per IEC 61169-8 Annex A	< 0.3UI (Reclocked) to 2.97Gb/s	
Standard:	-2dBm +/-1dBm	Equalization:	Automatic to 80m @ 3 Gb/s 100m@ 1.5Gb/s	Electrical:	
-S (Short haul):	-7dBm +/-1dBm	Return Loss:	> 15dB up to 1.5GHz	AC Input:	Auto-ranging, 100-240VAC, 50/60Hz
CWDM:	+3.5dBm +/-1dBm	> 10dB up to 3GHz		Power:	200W max
Wavelength:				Connector:	IEC 320 - 1 per power supply
Standard & -S:	310nm			Physical:	
CWDM:	1270nm-1610nm			Dimensions:	3.5"H x 19"W x 5.5"D
	ITU-T G.694.2 compliant			Module Capacity:	64 Evertz 3405 or 3505 SFP's

Ordering Information

3505FR-64-BNC2	High Density Fiber Optic SFP BNC Frame	3405T13-R-S	3G/HD/SD 1310nm reclocked SFP transmitter, short-haul, reclocked electrical loop output
<i>*Note: SFP's sold separately, please specify at the time of ordering. Multimode applications require a 5dB optical attenuator at the output of all transmitting ports, except when "-S" short haul version transmitter SFP's are used.</i>		3405Txx-R	3G/HD/SD reclocked CWDM SFP transmitter, reclocked electrical loop out
<i>Contact factory for all multimode applications.</i>		3405R-2	3G/HD/SD dual SFP receiver, non-reclocking
Ordering Options		3405R-2R	3G/HD/SD dual SFP receiver, reclocked outputs
+35PS	Redundant power supply	3405R-DA4R	3G/HD/SD single reclocked SFP receiver
Accessories:		3405OO13-DA4	3G/HD/SD reclocked SFP receiver/regenerator, reclocked 1310nm optical loop output and reclocked electrical outputs
3505FC	SNMP Frame Controller	3405OOxx-DA4	3G/HD/SD reclocked SFP receiver/regenerator, reclocked CWDM optical loop output and reclocked electrical outputs
3505FM	Spare/replacement fan module	3405DA5	3G/HD/SD distribution amplifier, reclocked
JL/LC/ATTEN-5DB	5dB optical attenuator. Required for multimode applications	<i>Note: xx versions include the following, 27,29,31,33,35,37,43,45,47,49,51,53,55,57,59,61</i>	
3505PS	Spare/replacement power supply module	<i>Note: xx/yy versions include the following:</i>	
Evertz SFP modules		<i>27/29, 31/33, 35/37, 43/45 - Low Band</i>	
3405T13-2	3G/HD/SD dual 1310nm SFP transmitter, non-reclocking	<i>47/49, 51/53, 55/57, 59/61 - High Band</i>	
3405T13-2-S	3G/HD/SD dual 1310nm SFP transmitter, non-reclocking, short-haul		
3405Txx/yy-2	3G/HD/SD dual CWDM SFP transmitter, non-reclocking		
3405T13-R	3G/HD/SD reclocked 1310nm SFP transmitter, reclocked electrical loop output		